

# **User Manual**

**3KW/5KW Rack**

**MPPT SOLAR INVERTER**

# Table Of Contents

<b>ABOUT THIS MANUAL .....</b>	<b>1</b>
Purpose.....	1
Scope.....	1
<b>SAFETY INSTRUCTIONS.....</b>	<b>1</b>
<b>INTRODUCTION .....</b>	<b>2</b>
Features.....	2
Basic System Architecture .....	2
Product Overview.....	3
<b>INSTALLATION .....</b>	<b>4</b>
Unpacking and Inspection.....	4
Installation.....	4
Battery Connection .....	5
AC Input/Output Connection.....	6
PV Connection .....	7
Communication Connection.....	8
Dry Contact Signal.....	9
BMS Communication .....	9
<b>OPERATION.....</b>	<b>10</b>
Power ON/OFF .....	10
Operation and Display Panel .....	10
LCD Display Icons .....	11
LCD Setting.....	13
Display Setting .....	19
Operating Mode Description .....	21
Fault Reference Code.....	23
Warning Indicator.....	24
Battery Equalization .....	24
<b>SPECIFICATIONS.....</b>	<b>26</b>
Table 1 Line Mode Specifications .....	26
Table 2 Battery Mode Specifications .....	27
Table 3 Charge Mode Specifications .....	28
Table 4 ECO/Bypass Mode Specifications.....	29
<b>TROUBLE SHOOTING .....</b>	<b>30</b>
<b>PARALLEL FUNCTION .....</b>	<b>31</b>
<b>Appendix A: Approximate Back-up Time Table.....</b>	<b>45</b>
<b>Appendix B: BMS Communication Installation .....</b>	<b>46</b>

# ABOUT THIS MANUAL

## Purpose

This manual describes the assembly, installation, operation and troubleshooting of this unit. Please read this manual carefully before installations and operations. Keep this manual for future reference.

## Scope

This manual provides safety and installation guidelines as well as information on tools and wiring.

# SAFETY INSTRUCTIONS



**WARNING: This chapter contains important safety and operating instructions. Read and keep this manual for future reference.**

1. Before using the unit, read all instructions and cautionary markings on the unit, the batteries and all appropriate sections of this manual.
2. **CAUTION** --To reduce risk of injury, charge only deep-cycle lead acid type rechargeable batteries. Other types of batteries may burst, causing personal injury and damage.
3. Do not disassemble the unit. Take it to a qualified service center when service or repair is required. Incorrect re-assembly may result in a risk of electric shock or fire.
4. To reduce risk of electric shock, disconnect all wirings before attempting any maintenance or cleaning. Turning off the unit will not reduce this risk.
5. **CAUTION** – Only qualified personnel can install this device with battery.
6. **NEVER** charge a frozen battery.
7. For optimum operation of this inverter/charger, please follow required spec to select appropriate cable size. It's very important to correctly operate this inverter/charger.
8. Be very cautious when working with metal tools on or around batteries. A potential risk exists to drop a tool to spark or short circuit batteries or other electrical parts and could cause an explosion.
9. Please strictly follow installation procedure when you want to disconnect AC or DC terminals. Please refer to INSTALLATION section of this manual for the details.
10. Fuses are provided as over-current protection for the battery supply.
11. GROUNDING INSTRUCTIONS -This inverter/charger should be connected to a permanent grounded wiring system. Be sure to comply with local requirements and regulation to install this inverter.
12. NEVER cause AC output and DC input short circuited. Do NOT connect to the mains when DC input short circuits.
13. **Warning!!** Only qualified service persons are able to service this device. If errors still persist after following troubleshooting table, please send this inverter/charger back to local dealer or service center for maintenance.

# INTRODUCTION

This is a multi-function inverter/charger, combining functions of inverter, MPPT solar charger and battery charger to offer uninterruptible power support with portable size. Its comprehensive LCD display offers user-configurable and easy-accessible button operation such as battery charging current, AC/solar charger priority, and acceptable input voltage based on different applications.

## Features

- Pure sine wave inverter
- Built-in MPPT solar charge controller
- Configurable input voltage range for home appliances and personal computers via LCD setting
- Configurable battery charging current based on applications via LCD setting
- Configurable AC/Solar Charger priority via LCD setting
- Compatible to mains voltage or generator power
- Auto restart while AC is recovering
- Overload/ Over temperature/ short circuit protection
- Smart battery charger design for optimized battery performance
- Cold start function
- Zero-transfer Time

## Basic System Architecture

The following illustration shows basic application for this inverter/charger. It also includes following devices to have a complete running system:

- Generator or Utility.
- PV modules

Consult with your system integrator for other possible system architectures depending on your requirements. This inverter can power all kinds of appliances in home or office environment, including motor-type appliances such as tube light, fan, refrigerator and air conditioner.

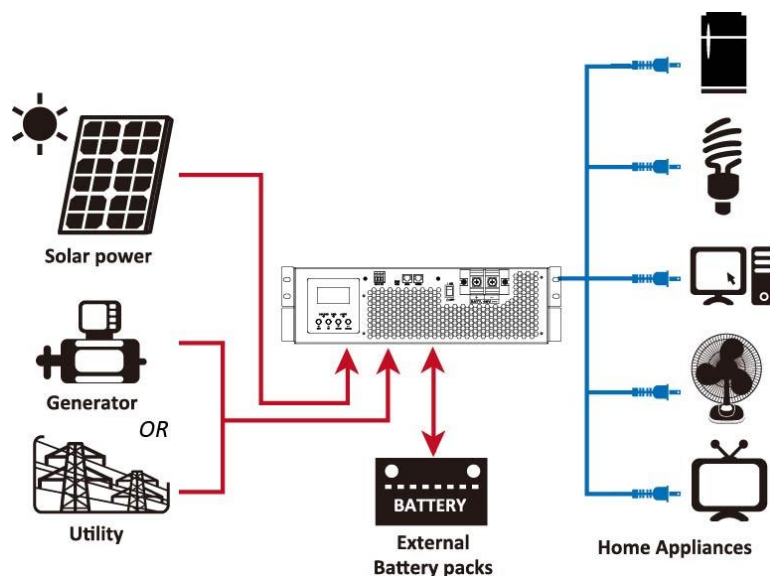
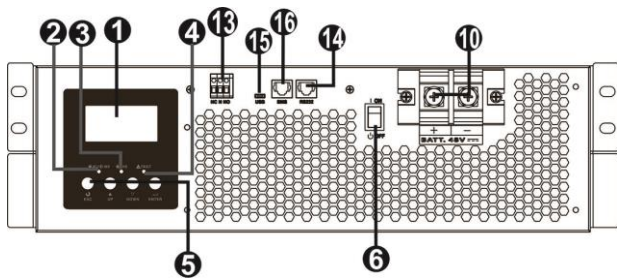
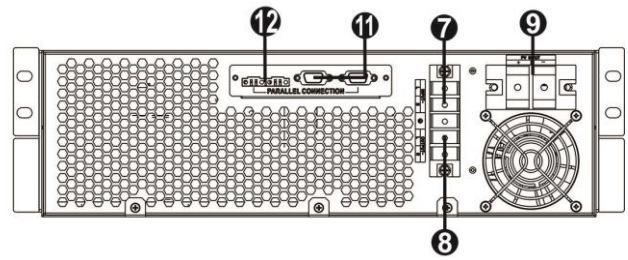

Figure 1 Hybrid Power System

## Product Overview



Front



Back

1. LCD display
2. Status indicator
3. Charging indicator
4. Fault indicator
5. Function buttons
6. Power on/off switch
7. AC input
8. AC output
9. PV input
10. Battery input
11. Parallel communication cable (only for parallel model)
12. Current sharing cable (only for parallel model)
13. Dry contact
14. RS-232 communication port
15. USB port
16. BMS communication port: CAN and RS232 or RS485

**NOTE:** For parallel model installation and operation, please check separate parallel installation guide for the details.

# INSTALLATION

## Unpacking and Inspection

Before installation, please inspect the unit. Be sure that nothing inside the package is damaged. You should have received the following items inside of package:

- The unit x 1
- User manual x 1
- Communication cable x 1
- Software CD x 1
- Parallel cable x 2

## Installation

Consider the following points before selecting where to install:

- Do not mount the inverter on flammable construction materials.
- Mount on a solid surface
- Install this inverter at eye level in order to allow the LCD display to be read at all times.
- The ambient temperature should be between 0°C and 40°C to ensure optimal operation.

## Rack Mounting

Please follow the diagram below to install the Inverter module in a 19-inch bay at the desired height in the upright cabinet. Secure the device adequately and fix it to the cabinet with six screws.

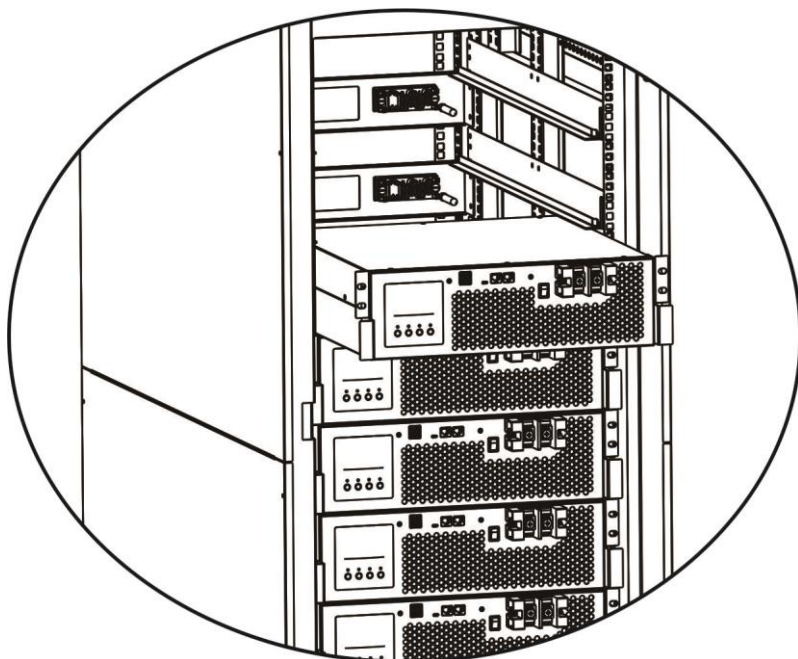

# Battery Connection

**CAUTION:** For safety operation and regulation compliance, it's requested to install a separate DC over-current protector or disconnect device between battery and inverter. It may not be requested to have a disconnect device in some applications, however, it's still requested to have over-current protection installed. Please refer to typical amperage in below table as required fuse or breaker size.

**WARNING!** All wiring must be performed by a qualified personnel.

**WARNING!** It's very important for system safety and efficient operation to use appropriate cable for battery connection. To reduce risk of injury, please use the proper recommended cable and terminal size as below.

**Ring terminal:**

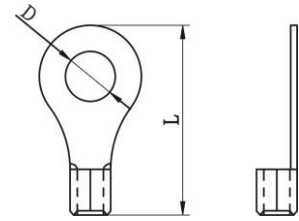



**Recommended battery cable and terminal size:**

Model	Typical Amperage	Battery Capacity	Wire Size	Ring Terminal			Torque Value
				Cable mm <sup>2</sup>	Dimensions		
					D (mm)	L (mm)	
3KW	200A	200AH	1*1/0AWG	60	8.4	49.7	4.5 Nm
			2*4AWG	44	8.4	49.7	
5KW	200A	200AH	1*1/0AWG	60	8.4	49.7	4.5 Nm
			2*4AWG	44	8.4	49.7	

Please follow below steps to implement battery connection:

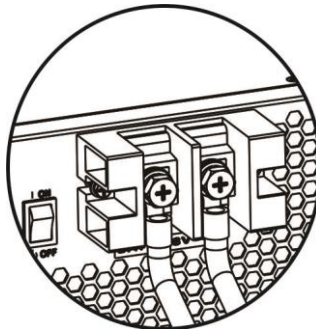
1. Assemble battery ring terminal based on recommended battery cable and terminal size.
2. Connect all battery packs as units requires. It's suggested to connect at least 200Ah capacity battery for 3KW model and at least 200Ah capacity battery for 5KW model.
3. Insert the ring terminal of battery cable flatly into battery connector of inverter and make sure the bolts are tightened with torque of 2-3 Nm. Make sure polarity at both the battery and the inverter/charge is correctly connected and ring terminals are tightly screwed to the battery terminals.



 **WARNING: Shock Hazard**  
Installation must be performed with care due to high battery voltage in series.

 **CAUTION!!** Do not place anything between the flat part of the inverter terminal and the ring terminal. Otherwise, overheating may occur.  
**CAUTION!!** Do not apply anti-oxidant substance on the terminals before terminals are connected tightly.  
**CAUTION!!** Before making the final DC connection or closing DC breaker/disconnector, be sure positive (+) must be connected to positive (+) and negative (-) must be connected to negative (-).

## AC Input/Output Connection

**CAUTION!!** Before connecting to AC input power source, please install a **separate** AC breaker between inverter and AC input power source. This will ensure the inverter can be securely disconnected during maintenance and fully protected from over current of AC input. The recommended spec of AC breaker is 30A for 3KW and 50A for 5KW.

**CAUTION!!** There are two terminal blocks with "IN" and "OUT" markings. Please do NOT mis-connect input and output connectors.

**WARNING!** All wiring must be performed by a qualified personnel.

**WARNING!** It's very important for system safety and efficient operation to use appropriate cable for AC input connection. To reduce risk of injury, please use the proper recommended cable size as below.

### Suggested cable requirement for AC wires

Model	Typical Amperage	Wire Size	Ring Terminal			Torque Value
			Cable mm <sup>2</sup>	Dimensions		
				D (mm)	L (mm)	
3KW	20A	10 AWG	5.5	5.3	19	1.4~1.6 Nm
5KW	40A	8 AWG	8	5.3	19	1.4~1.6 Nm

Please follow below steps to implement AC input/output connection:

1. Assemble the ring terminal based on the recommended cable and terminal size
2. Insert the ring terminal of the cable flatly into AC input connector of inverter and make sure the bolts are tightened with torque of 2-3 Nm. Make sure the terminals are tightly screwed. Be sure to connect PE protective conductor (⊕) first.

⊕ → **Ground (yellow-green)**

L → **LINE (brown or black)**

N → **Neutral (blue)**

**Ring terminal:**

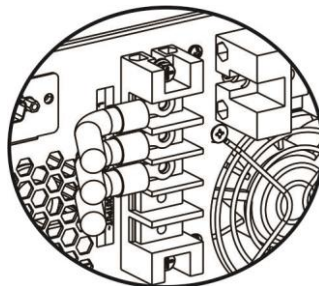
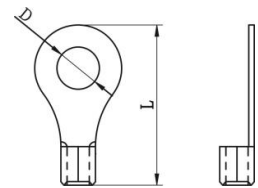

**WARNING:**

Be sure that AC power source is disconnected before attempting to hardwire it to the unit.

3. Then, Insert the ring terminal of the cable flatly into AC output connector of inverter and make sure the bolts are tightened with torque of 2-3 Nm. Make sure the terminals are tightly screwed. Be sure to connect PE protective conductor (⊕) first.

⊕ → **Ground (yellow-green)**

L → **LINE (brown or black)**

N → **Neutral (blue)**



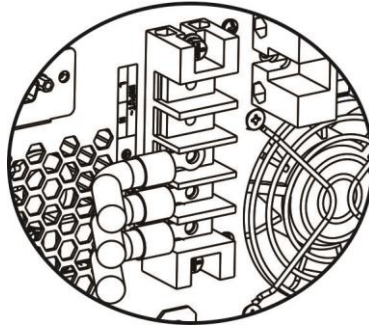

4. Make sure the wires are securely connected.

**CAUTION: Important**

Be sure to connect AC wires with correct polarity. If L and N wires are connected reversely, it may cause utility short-circuited when these inverters are worked in parallel operation.

**CAUTION:** Appliances such as air conditioner are required at least 2~3 minutes to restart because it's required to have enough time to balance refrigerant gas inside of circuits. If a power shortage occurs and recovers in a short time, it will cause damage to your connected appliances. To prevent this kind of damage, please check manufacturer of air conditioner if it's equipped with time-delay function before installation. Otherwise, this inverter/charger will trig overload fault and cut off output to protect your appliance but sometimes it still causes internal damage to the air conditioner.

**CAUTION: Important**

When input source is the generator, it's suggested to choose the generator by following parameters:

- The recommend generator rating should be at least 2X of inverter capacity.
- Generator output: Pure Sine Wave
- Generator output voltage rms range: 180 ~ 270Vac
- Generator output frequency range: 45Hz ~ 63Hz

It's recommended to test the generator with the inverter before the installation. Few generators complied above parameters may still not be accepted by the inverter as the input source.

## PV Connection

**CAUTION:** Before connecting to PV modules, please install **separately** a DC circuit breaker between inverter and PV modules.

**WARNING!** All wiring must be performed by a qualified personnel.

**WARNING!** It's very important for system safety and efficient operation to use appropriate cable for PV module connection. To reduce risk of injury, please use the proper recommended cable size as below.

Model	Typical Amperage	Wire Size	Ring Terminal			Torque Value
			Cable mm <sup>2</sup>	Dimensions		
				D (mm)	L (mm)	
3KW	60A	8 AWG	8	6.4	29.8	2~3 Nm
5KW	80A	6 AWG	14	6.4	29.8	2~3 Nm

**PV Module Selection:**

When selecting proper PV modules, please be sure to consider below parameters:

1. Open circuit Voltage (Voc) of PV modules not exceeds max. PV array open circuit voltage of inverter.
2. Open circuit Voltage (Voc) of PV modules should be higher than min. battery voltage.

Solar Charging Mode		
INVERTER MODEL	3KW	5KW
Max. PV Array Open Circuit Voltage	145Vdc	
PV Array MPPT Voltage Range	30~115Vdc	60~115Vdc

Please follow below steps to implement PV module connection:

1. Assemble the ring terminal based on the recommended cable and terminal size.
2. Check correct polarity of connection cable from PV modules and PV input connectors. Then, connect positive pole (+) of connection cable to positive pole (+) of PV input connector. Connect negative pole (-) of connection cable to negative pole (-) of PV input connector.

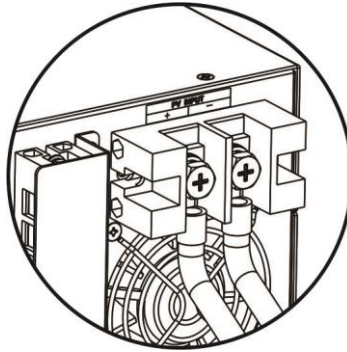
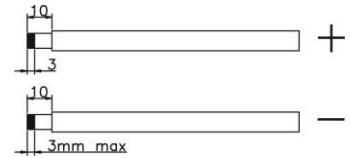

3. Make sure the wires are securely connected.

## Communication Connection

### Serial Connection

Please use supplied communication cable to connect to inverter and PC. Insert bundled CD into a computer and follow on-screen instruction to install the monitoring software. For the detailed software operation, please check user manual of software inside of CD.



## Dry Contact Signal

There is one dry contact (3A/250VAC) available on the rear panel. It could be used to deliver signal to external device when battery voltage reaches warning level.

Unit Status	Condition		Dry contact port: 		
			NC & C	NO & C	
Power Off	Unit is off and no output is powered.		Close	Open	
Power On	Output is powered from Utility.		Close	Open	
	Output is powered from Battery power or Solar energy.	Program 01 set as USB (utility first)	Battery voltage < Low DC warning voltage	Open	Close
			Battery voltage > Setting value in Program 13 or battery charging reaches floating stage	Close	Open
		Program 01 is set as SBU (SBU priority) or SUB (solar first)	Battery voltage < Setting value in Program 12	Open	Close
			Battery voltage > Setting value in Program 13 or battery charging reaches floating stage	Close	Open

## BMS Communication

If connecting to lithium battery, it's requested to buy a special communication cable. For the detailed BMS communication and installation, please check Appendix B – BMS Communication Installation.

# OPERATION

## Power ON/OFF

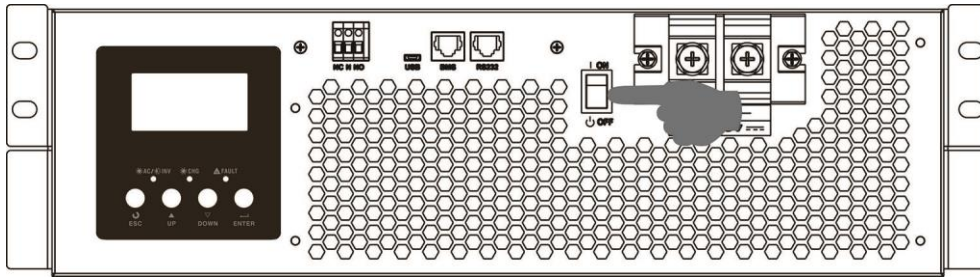

Once the unit has been properly installed and the batteries are connected well, simply press On/Off switch (located on the button of the case) to turn on the unit.

## Operation and Display Panel

The operation and display panel, shown in below chart, is on the front panel of the inverter. It includes three indicators, four function keys and a LCD display, indicating the operating status and input/output power information.

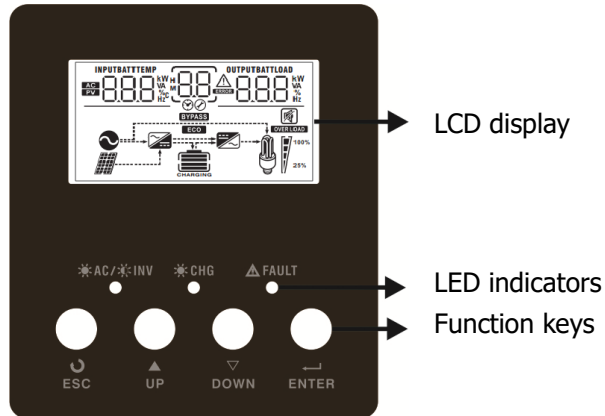

### LED Indicator

LED Indicator		Messages	
☀️ AC / ☀️ INV	Green	Solid On	Output is powered by utility in Line mode.
		Flashing	Output is powered by battery or PV in battery mode.
☀️ CHG	Green	Solid On	Battery is fully charged.
		Flashing	Battery is charging.
⚠️ FAULT	Red	Solid On	Fault occurs in the inverter.
		Flashing	Warning condition occurs in the inverter.

### Function Keys

Function Key	Description
ESC	To exit setting mode
UP	To go to previous selection
DOWN	To go to next selection
ENTER	To confirm the selection in setting mode or enter setting mode

# LCD Display Icons

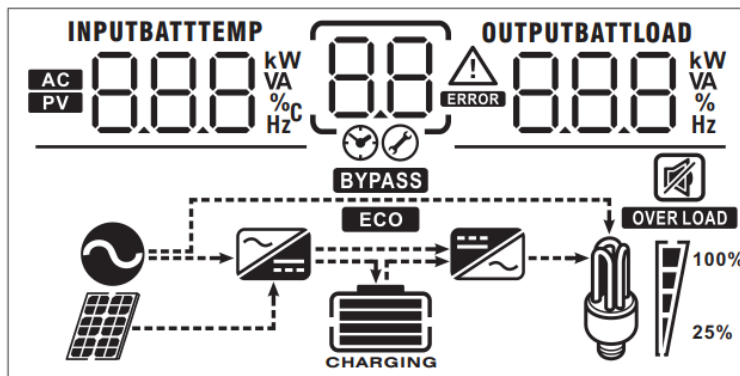

Icon	Function description	
<b>Input Source Information</b>		
<b>AC</b>	Indicates the AC input.	
<b>PV</b>	Indicates the PV input	
<b>INPUTBATT</b> 888 kW VA %C Hz	Indicate input voltage, input frequency, PV voltage, battery voltage and charger current.	
<b>Configuration Program and Fault Information</b>		
88 ⌚	Indicates the setting programs.	
	Indicates the warning and fault codes.	
88 ⚠️ ERROR	Warning: 88 ⚠️ flashing with warning code.	
88 ERROR	Fault: 88 ERROR lighting with fault code	
<b>Output Information</b>		
<b>OUTPUTBATTLOAD</b> 888 kW VA % Hz	Indicate output voltage, output frequency, load percent, load in VA, load in Watt and discharging current.	
<b>Battery Information</b>		
	Indicates battery level by 0-24%, 25-49%, 50-74% and 75-100% in battery mode and charging status in line mode.	
In AC mode, it will present battery charging status.		
Status	Battery voltage	LCD Display
Constant Current mode / Constant Voltage mode	<2V/cell	4 bars will flash in turns.
	2 ~ 2.083V/cell	Bottom bar will be on and the other three bars will flash in turns.
	2.083 ~ 2.167V/cell	Bottom two bars will be on and the other two bars will flash in turns.
	> 2.167 V/cell	Bottom three bars will be on and the top bar will flash.
Floating mode. Batteries are fully charged.		4 bars will be on.

In battery mode, it will present battery capacity.

Load Percentage	Battery Voltage	LCD Display
Load > 50%	< 1.717V/cell	
	1.717V/cell ~ 1.8V/cell	
	1.8 ~ 1.883V/cell	
	> 1.883 V/cell	
50% > Load > 20%	< 1.817V/cell	
	1.817V/cell ~ 1.9V/cell	
	1.9 ~ 1.983V/cell	
	> 1.983	
Load < 20%	< 1.867V/cell	
	1.867V/cell ~ 1.95V/cell	
	1.95 ~ 2.033V/cell	
	> 2.033	

### Load Information

	Indicates overload.			
	Indicates the load level by 0-24%, 25-49%, 50-74% and 75-100%.			
	0%~24%	25%~49%	50%~74%	75%~100%

### Mode Operation Information

	Indicates unit connects to the mains.
	Indicates unit connects to the PV panel.
	Indicates inverter will work in Bypass mode
	Indicates inverter will work in ECO mode
	Indicates the utility charger circuit is working.
	Indicates the DC/AC inverter circuit is working.

### Mute Operation

	Indicates unit alarm is disabled.
--	-----------------------------------

## LCD Setting









After pressing and holding ENTER button for 3 seconds, the unit will enter setting mode. Press "UP" or "DOWN" button to select setting programs. And then, press "ENTER" button to confirm the selection or ESC button to exit.

### Setting Programs:







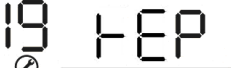



Program	Description	Selectable option	
00	Exit setting mode	Escape 00 ESC	
01	Output source priority: To configure load power source priority	USB : Utility first (default) 01 USB	Utility will provide power to the loads as first priority. If Utility energy is unavailable, solar energy and battery provides power the loads.
		SUB: Solar first 01 SUB	Solar energy provides power to the loads as first priority. If solar energy is not sufficient to power all connected loads, utility energy will supply power to the loads at the same time. Battery provides power to the loads only when solar and utility is not sufficient.
		SBU priority 01 SBU	Solar energy provides power to the loads as first priority. If solar energy is not sufficient to power all connected loads, battery energy will supply power to the loads at the same time. Utility provides power to the loads only when battery voltage drops to either low-level warning voltage or the setting point in program 12 or solar and battery is not sufficient.
02	Maximum charging current: To configure total charging current for solar and utility chargers. (Max. charging current = utility charging current + solar charging current)	60A (default) 02 60 <sup>A</sup>	The setting range is from 10A to 140A and increment of each click is 10A.

05	Battery type	AGM (default) 05 AGM	Flooded 05 FLd
		User-Defined 05 USE	If "User-Defined" is selected, battery charge voltage and low DC cut-off voltage can be set up in program 26, 27 and 29.
06	Auto restart when overload occurs	Restart disable (default) 06 Lfd	Restart enable 06 LfE
07	Auto restart when over temperature occurs	Restart disable (default) 07 tfd	Restart enable 07 tFE
09	Output frequency	50Hz (default) 09 50 Hz	60Hz 09 60 Hz
10	Operation Logic	Automatically (default) 10 AUT	If selected and utility is available, inverter will work in line mode. Once utility frequency is unstable, inverter will work in bypass mode if bypass function is not forbidden in program 23.
		Online mode 10 ONL	If selected, inverter will work in line mode when utility is available.
		ECO Mode 10 ECO	If selected and bypass is not forbidden in program 23, inverter will work in ECO mode when utility is available.
11	Maximum utility charging current	2A 11 2A	10A 11 10A
		20A 11 20A	30A (default) 11 30A
		40A 11 40A	50A 11 50A
		60A 11 60A	
12	Setting voltage point back to utility source when selecting "SBU" (SBU priority) or "SUB" (Solar first) in program 01	Default setting: 46.0V 12 BATT 46 V	
		The setting range is from 44.0V to 57.0V and increment of each click is 1.0V.	

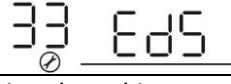

13	Setting voltage point back to battery mode when selecting "SBU" (SBU priority) or "SUB" (Solar first) in program 01	Battery fully charged 	54.0V (default) 
		The setting range is from 48.0V to 64.0V and increment of each click is 1.0V.	
16	Solar energy priority: To configure solar energy priority for battery and load	SBL: Solar energy for battery first UCB: Allow utility to charge battery (Default)  	Solar energy charges battery first and allow the utility to charge battery.
		SBL: Solar energy for battery first UdC: Disallow utility to charge battery  	Solar energy charge battery first and disallow the utility to charge battery.
		SLb: Solar energy for load first UCb: Allow utility to charge battery  	Solar energy provides power to the load first and also allow the utility to charge battery.
		SLb: Solar energy for load first UdC: Disallow utility to charge battery  	Solar energy provides power to the load first and disallow the utility to charge battery.
18	Alarm control	Alarm on (default) 	Alarm off 
19	Auto return to default display screen	Return to default display screen (default) 	If selected, no matter how users switch display screen, it will automatically return to default display screen (Input voltage /output voltage) after no button is pressed for 1 minute.
		Stay at latest screen 	If selected, the display screen will stay at latest screen user finally switches.

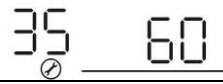
20	Backlight control	Backlight on (default) 20 LON	Backlight off 20 LOF
22	Beeps while primary source is interrupted	Alarm on (default) 22 AON	Alarm off 22 AOF
23	Bypass function:	Bypass Forbidden 23 BYF	If selected, inverter won't work in bypass/ECO modes.
		Bypass disable 23 BYD	If selected and power ON button is pressed on, inverter can work in bypass/ECO mode only if utility is available.
		Bypass enable (default) 23 BYE	If selected and no matter power ON button is pressed on or not, inverter can work in bypass mode if utility is available.
25	Record Fault code	Record enable 25 FEN	Record disable (default) 25 FDS
26	Bulk charging voltage (C.V voltage)	Default setting: 56.4V CU 26 56.4 <sup>BATT</sup> v	
		If self-defined is selected in program 5, this program can be set up. Setting range is from 48.0V to 64.0V. Increment of each click is 0.1V.	
27	Floating charging voltage	Default setting: 54.0V FLU 27 54.0 <sup>BATT</sup> v	
		If self-defined is selected in program 5, this program can be set up. Setting range is from 48.0V to 64.0V. Increment of each click is 0.1V.	
28	AC output mode *This setting is able to set up only when the inverter is in standby mode. Be sure that on/off switch is in "OFF" status	Single: 28 <sup>OUTPUT</sup> S10	When the units are used in parallel with single phase, please select "PAL" in program 28.
		Parallel: 28 <sup>OUTPUT</sup> PAL	It is required to have at least 3 inverters or maximum 9 inverters to support three-phase equipment. It's required to have at least one inverter in each phase or it's up to four inverters in one phase. Please refers to 5-2 for detailed information. Please select "3P1" in program
		L1 phase: 28 <sup>OUTPUT</sup> 3P1	

		L2 phase: 	28 for the inverters connected to L1 phase, "3P2" in program 28 for the inverters connected to L2 phase and "3P3" in program 28 for the inverters connected to L3 phase.  Be sure to connect share current cable to units which are on the same phase. Do NOT connect share current cable between units on different phases.
		L3 phase: 	
29	Low DC cut-off voltage	Default setting: 42.0V 	
		If self-defined is selected in program 5, this program can be set up. Setting range is 40.0V to 54.0V. Increment of each click is 0.1V. Low DC cut-off voltage will be fixed to setting value no matter what percentage of load is connected.	
32	Bulk charging time (C.V stage) (Only available for 4KVA/5KVA model)	Automatically (Default): 	If selected, inverter will judge this charging time automatically.  If "User-Defined" is selected in program 05, this program can be set up. Setting range is from 5min to 900min. Increment of each click is 5min. Otherwise, Keeping auto-charging time.
		5 min 	
		900 min 	
		If "USE" is selected in program 05, this program can be set up.	
33	Battery equalization	Battery equalization enable 	Battery equalization disable (default) 
		If "Flooded" or "User-Defined" is selected in program 05, this program can be set up.	
34	Battery equalization voltage	Default setting: 58.4V 	
		Setting range is from 48.0V to 64.0V. Increment of each click is 0.1V.	
35	Battery equalized time	60min (default) 	Setting range is from 5min to 900min. Increment of each click is 5min.
36	Battery equalized timeout	120min (default) 	Setting range is from 5min to 900 min. Increment of each click is 5 min.

37	Equalization interval	30days (default) 37 30d	Setting range is from 0 to 90 days. Increment of each click is 1 day
39	Equalization activated immediately	Enable 39 AEN	Disable (default) 39 AdS
		<p>If equalization function is enabled in program 33, this program can be set up. If "Enable" is selected in this program, it's to activate battery equalization immediately and LCD main page will shows "E9". If "Disable" is selected, it will cancel equalization function until next activated equalization time arrives based on program 37 setting. At this time, "E9" will not be shown in LCD main page.</p>	

## Display Setting



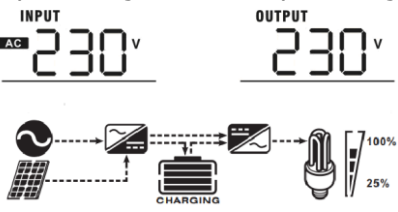
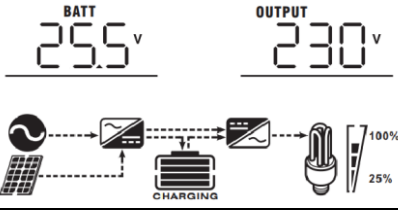
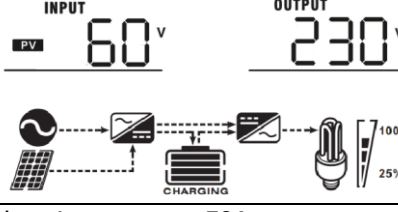
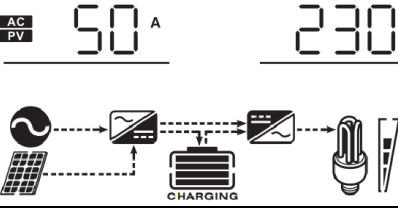
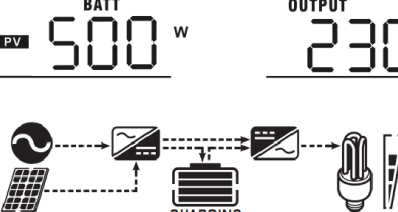
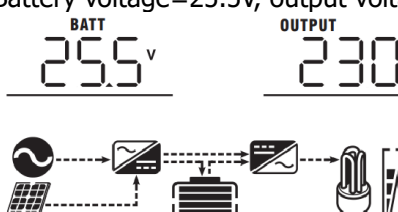

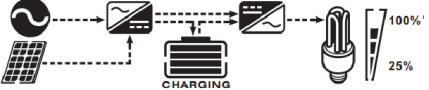
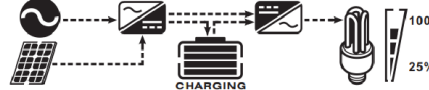
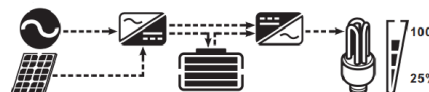
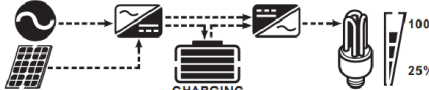
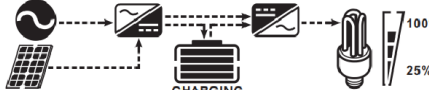
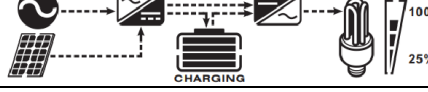
The LCD display information will be switched in turns by pressing "UP" or "DOWN" key. The selectable information is switched as below order: input voltage, input frequency, PV voltage, MPPT charging current, MPPT charging power, battery voltage, output voltage, output frequency, load percentage, load in VA, load in Watt, DC discharging current, main CPU Version and second CPU Version.

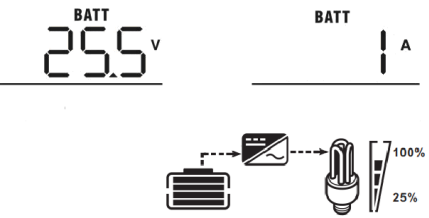
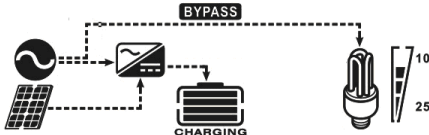
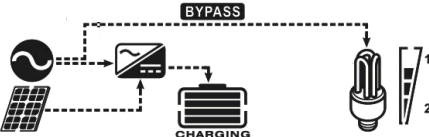

Selectable information	LCD display
Input voltage/Output voltage (Default Display Screen)	Input Voltage=230V, output voltage=230V 
Input frequency	Input frequency=50Hz 
PV voltage	PV voltage=60V 
Charging current	charging current=50A 
PV power	PV power = 500W 
Battery voltage and output voltage	Battery voltage=25.5V, output voltage=230V 

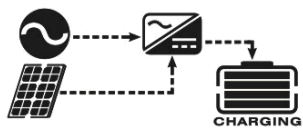
Output frequency	<p>Output frequency=50Hz</p> <p>BATT 25.5<sup>v</sup>      OUTPUT 50.0<sup>Hz</sup></p> 
Load percentage	<p>Load percent=70%</p> <p>BATT 25.5<sup>v</sup>      LOAD 70<sup>%</sup></p> 
Load in VA	<p>When connected load is lower than 1kVA, load in VA will present xxxVA like below chart.</p> <p>BATT 25.5<sup>v</sup>      LOAD 350<sup>VA</sup></p>  <p>When load is larger than 1kVA (<math>\geq 1\text{kVA}</math>), load in VA will present x.xkVA like below chart.</p> <p>BATT 25.5<sup>v</sup>      LOAD 150<sup>kVA</sup></p> 
Load in Watt	<p>When load is lower than 1kW, load in W will present xxxW like below chart.</p> <p>INPUT AC 230<sup>v</sup>      LOAD 120<sup>kW</sup></p>  <p>When load is larger than 1kW (<math>\geq 1\text{kW}</math>), load in W will present x.xkW like below chart.</p> <p>INPUT AC 230<sup>v</sup>      LOAD 120<sup>kW</sup></p> 

Battery voltage/DC discharging current	<p>Battery voltage=25.5V, discharging current=1A</p> 
Main CPU version checking	<p>Main CPU version 00014.04</p> 
Secondary CPU version checking	<p>Secondary CPU version 00003.03</p> 

## Operating Mode Description

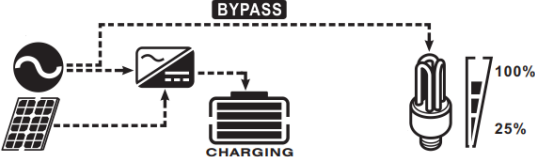
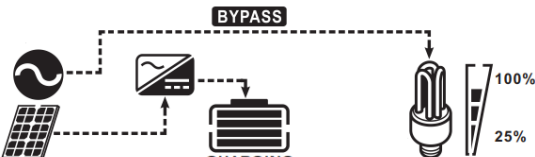
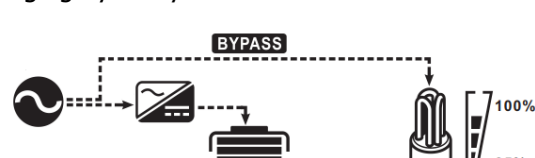
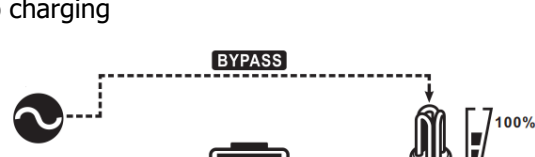
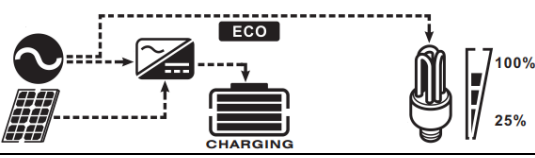
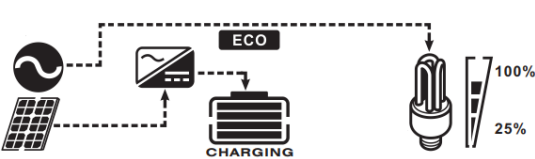
Operation mode	Description	LCD display
<p>Standby mode</p> <p><b>Note:</b></p> <p>*Standby mode: The inverter is not turned on yet but at this time, the inverter can charge battery without AC output.</p>	<p>No output is supplied by the unit but it still can charge batteries.</p>	<p>Charging by utility and PV energy.</p> 
		<p>Charging by utility.</p> 
		<p>Charging by PV energy.</p> 
		<p>No charging.</p> 

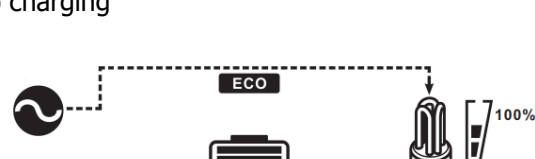





<p>Bypass Mode</p>	<p>The unit will provide output power from the utility. PV energy and utility can charge batteries.</p>	<p>Charging by utility and PV energy.</p>  <p>Charging by PV</p>  <p>Charging by utility</p>  <p>No charging</p> 
<p>ECO Mode</p>	<p>The unit will provide output power from the utility. PV energy and utility can charge batteries.</p>	<p>Charging by utility and PV energy.</p>  <p>Charging by PV</p>  <p>Charging by utility</p>  <p>No charging</p> 









<p>Fault mode</p> <p>Note:</p> <p>*Fault mode: Errors are caused by inside circuit error or external reasons such as over temperature, output short circuited and so on.</p>	<p>Utility can bypass.</p>	<p>No charging and Bypass</p>
		<p>No charging</p>
<p>Line Mode</p>	<p>The unit will provide output power from the mains. It will also charge the battery at line mode.</p>	<p>Charging by utility and PV energy.</p>
		<p>Charging by utility.</p>
<p>Battery Mode</p>	<p>The unit will provide output power from battery and PV power.</p>	<p>Power from battery and PV energy.</p>
		<p>Power from battery only.</p>

## Fault Reference Code

Fault Code	Fault Event	Icon on
01	Fan is locked when inverter is off.	
02	Over temperature	
03	Battery voltage is too high	
04	Battery voltage is too low	
05	Output short circuited or over temperature is detected by internal converter components.	
06	Output voltage is abnormal. (For 1K/2K/3K model) Output voltage is too high. (For 4K/5K model)	
07	Overload time out	
08	Bus voltage is too high	
09	Bus soft start failed	
50	PFC over current	
51	Over current or surge	

52	Bus voltage is too low	
53	Inverter soft start failed	
55	Over DC voltage in AC output	
56	Battery connection is open	
57	Current sensor failed	
58	Output voltage is too low	

## Warning Indicator

Warning Code	Warning Event	Audible Alarm	Icon flashing
01	Fan is locked when inverter is on.	Beep three times every second	
02	Over temperature	None	
03	Battery is over-charged	Beep once every second	
04	Low battery	Beep once every second	
07	Overload	Beep once every 0.5 second	
10	Output power derating	Beep twice every 3 seconds	
E9	Battery equalization	None	

## Battery Equalization

Equalization function is added into charge controller. It reverses the buildup of negative chemical effects like stratification, a condition where acid concentration is greater at the bottom of the battery than at the top. Equalization also helps to remove sulfate crystals that might have built up on the plates. If left unchecked, this condition, called sulfation, will reduce the overall capacity of the battery. Therefore, it's recommended to equalize battery periodically.

- **How to Apply Equalization Function**

You must enable battery equalization function in monitoring LCD setting program 33 first. Then, you may apply this function in device by either one of following methods:

1. Setting equalization interval in program 37.
2. Active equalization immediately in program 39.

- **When to Equalize**

In float stage, when the setting equalization interval (battery equalization cycle) is arrived, or equalization is active immediately, the controller will start to enter Equalize stage.

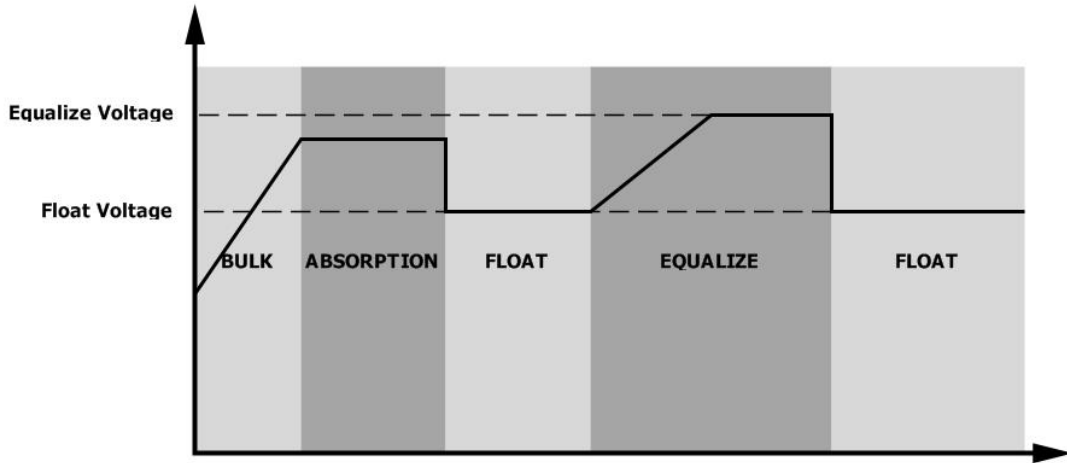

- **Equalize charging time and timeout**

In Equalize stage, the controller will supply power to charge battery as much as possible until battery voltage raises to battery equalization voltage. Then, constant-voltage regulation is applied to maintain battery voltage at the battery equalization voltage. The battery will remain in the Equalize stage until setting battery equalized time is arrived.

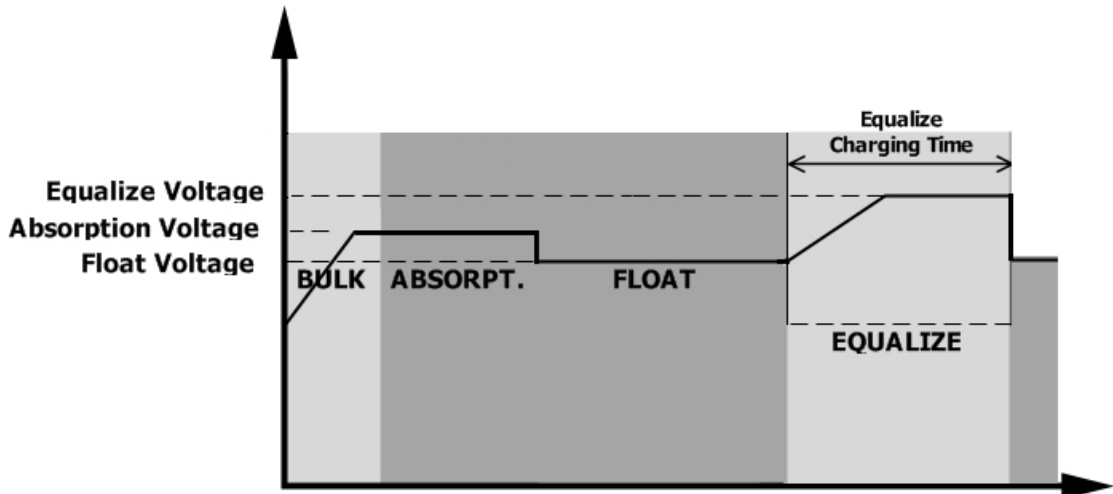

However, in Equalize stage, when battery equalized time is expired and battery voltage doesn't rise to battery equalization voltage point, the charge controller will extend the battery equalized time until battery voltage achieves battery equalization voltage. If battery voltage is still lower than battery equalization voltage when battery equalized timeout setting is over, the charge controller will stop equalization and return to float stage.

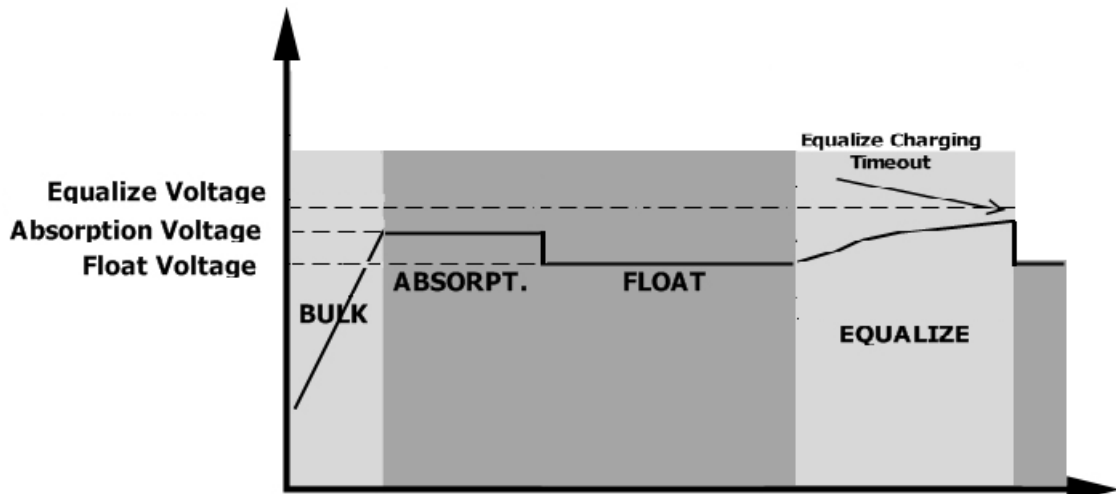

# SPECIFICATIONS

Table 1 Line Mode Specifications

INVERTER MODEL	3KW	5KW
<b>Input Voltage Waveform</b>	Sinusoidal	
<b>Nominal Input Voltage</b>	230Vac	
<b>Low Loss Voltage</b>	110Vac±7V	
<b>Low Loss Return Voltage</b>	120Vac±7V	
<b>High Loss Voltage</b>	280Vac±7V	
<b>High Loss Return Voltage</b>	270Vac±7V	
<b>Max AC Input Voltage</b>	300Vac	
<b>Nominal Input Frequency</b>	50Hz / 60Hz (Auto detection)	
<b>Low Loss Frequency</b>	46(56)±1Hz	
<b>Low Loss Return Frequency</b>	46.5(57)±1Hz	
<b>High Loss Frequency</b>	54(64)±1Hz	
<b>High Loss Return Frequency</b>	53(63)±1Hz	
<b>Power Factor</b>	>0.98	
<b>Output Short Circuit Protection</b>	Line mode: Circuit Breaker Battery mode: Electronic Circuits	
<b>Efficiency (Line Mode)</b>	93% (Peak Efficiency)	
<b>Transfer Time</b>	Line mode←→Battery mode 0ms Inverter←→Bypass 4ms	

Table 2 Battery Mode Specifications

<b>INVERTER MODEL</b>	<b>3KW</b>	<b>5KW</b>
<b>Rated Output Power</b>	3KVA/3KW	5KVA/5KW
<b>Output Voltage Waveform</b>	Pure Sine Wave	
<b>Output Voltage Regulation</b>	230Vac±5%	
<b>Output Frequency</b>	50Hz or 60Hz	
<b>Peak Efficiency</b>	90%	
<b>Overload Protection</b>	5s@≥150% load; 10s@105%~150% load	
<b>Surge Capacity</b>	2* rated power for 5 seconds	
<b>Nominal DC Input Voltage</b>	24Vdc	48Vdc
<b>Operating Range</b>	20Vdc -34Vdc	40Vdc -66Vdc
<b>Cold Start Voltage</b>	23Vdc	46Vdc
<b>Low DC Warning Voltage</b> @ load < 50% @ load ≥ 50%	22.5Vdc 22.0Vdc	45.0Vdc 44.0Vdc
<b>Low DC Warning Return Voltage</b> @ load < 50% @ load ≥ 50%	23.5Vdc 23.0Vdc	47.0Vdc 46.0Vdc
<b>Low DC Cut-off Voltage</b> @ load < 50% @ load ≥ 50%	21.5Vdc 21.0Vdc	43.0Vdc 42.0Vdc
<b>High DC Recovery Voltage</b>	32Vdc	64Vdc
<b>High DC Cut-off Voltage</b>	34Vdc	66Vdc
<b>No Load Power Consumption</b>	<75W	<75W

Table 3 Charge Mode Specifications

Utility Charging Mode			
INVERTER MODEL	3KW	5KW	
Charging Current @ Nominal Input Voltage	Default: 30A, max: 60A		
Bulk Charging Voltage	Flooded Battery	29.2Vdc	58.4Vdc
	AGM / Gel Battery	28.2Vdc	56.4Vdc
Floating Charging Voltage	27Vdc	54Vdc	
Overcharge Protection	34Vdc	66Vdc	
Charging Algorithm	3-Step		
Charging Curve			

Solar Charging Mode (MPPT type)		
INVERTER MODEL	3KW	5KW
Rated Power	1500W	4000W
Maximum charging current	60A	80A
Efficiency	98.0% max.	
Max. PV Array Open Circuit Voltage	145Vdc	
PV Array MPPT Voltage Range	30~115Vdc	60~115Vdc
Battery Voltage Accuracy	+/-0.3%	
PV Voltage Accuracy	+/-2V	
Charging Algorithm	3-Step	
Joint Utility and Solar Charging		
Max Charging Current	120A	140A
Default Charging Current	60A	

Table 4 ECO/Bypass Mode Specifications

<b>Bypass Mode</b>		
<b>INVERTER MODEL</b>	<b>3KW</b>	<b>5KW</b>
<b>Input Voltage Waveform</b>	Sinusoidal	
<b>Low Loss Voltage</b>	176Vac±7V	
<b>Low Loss Return Voltage</b>	186Vac±7V	
<b>High Loss Voltage</b>	280Vac±7V	
<b>High Loss Return Voltage</b>	270Vac±7V	
<b>Nominal Input Frequency</b>	50Hz / 60Hz (Auto detection)	
<b>Low Loss Frequency</b>	46(56)±1Hz	
<b>Low Loss Return Frequency</b>	46.5(57)±1Hz	
<b>High Loss Frequency</b>	54(64)±1Hz	
<b>High Loss Return Frequency</b>	53(63)±1Hz	

Table 5 General Specifications

<b>INVERTER MODEL</b>	<b>3KW</b>	<b>5KW</b>
<b>SCC type</b>	<b>MPPT</b>	
<b>Parallel-able</b>	YES	
<b>Communication</b>	RS232	
<b>Safety Certification</b>	CE	
<b>Operating Temperature Range</b>	0°C to 55°C	
<b>Storage temperature</b>	-15°C~ 60°C	
<b>Humidity</b>	5% to 95% Relative Humidity (Non-condensing)	
<b>Dimension (D*W*H), mm</b>	466.3 x 438 x 130.8	
<b>Net Weight, kg</b>	14.5	15

# TROUBLE SHOOTING

Problem	LCD/LED/Buzzer	Explanation / Possible cause	What to do
Unit shuts down automatically during startup process.	LCD/LEDs and buzzer will be active for 3 seconds and then complete off.	The battery voltage is too low (<1.91V/Cell)	1. Re-charge battery. 2. Replace battery.
No response after power on.	No indication.	1. The battery voltage is far too low. (<1.4V/Cell) 2. Battery polarity is connected reversed.	1. Check if batteries and the wiring are connected well. 2. Re-charge battery. 3. Replace battery.
Mains exist but the unit works in battery mode.	Input voltage is displayed as 0 on the LCD and green LED is flashing.	Input protector is tripped	Check if AC breaker is tripped and AC wiring is connected well.
	Green LED is flashing.	Insufficient quality of AC power. (Shore or Generator)	1. Check if AC wires are too thin and/or too long. 2. Check if generator (if applied) is working well or if input voltage range setting is correct. (UPS→Appliance)
	Green LED is flashing.	Set "Solar First" as the priority of output source.	Change output source priority to Utility first.
When the unit is turned on, internal relay is switched on and off repeatedly.	LCD display and LEDs are flashing	Battery is disconnected.	Check if battery wires are connected well.
Buzzer beeps continuously and red LED is on.	Fault code 07	Overload error. The inverter is overload 110% and time is up.	Reduce the connected load by switching off some equipment.
	Fault code 05	Output short circuited.	Check if wiring is connected well and remove abnormal load.
	Fault code 02	Internal temperature of inverter component is over 100°C.	Check whether the air flow of the unit is blocked or whether the ambient temperature is too high.
	Fault code 03	Battery is over-charged.	Return to repair center.
		The battery voltage is too high.	Check if spec and quantity of batteries are meet requirements.
	Fault code 01	Fan fault	Replace the fan.
	Fault code 06/58	Output abnormal (Inverter voltage below than 190Vac or is higher than 260Vac)	1. Reduce the connected load. 2. Return to repair center
	Fault code 08/09/53/57	Internal components failed.	Return to repair center.
	Fault code 50	PFC over current or surge.	Restart the unit, if the error happens again, please return to repair center.
	Fault code 51	OP over current or surge.	
	Fault code 52	Bus voltage is too low.	
	Fault code 55	Output voltage is unbalanced.	If the battery is connected well, please return to repair center.
Fault code 56	Battery is not connected well or fuse is burnt.		



# PARALLEL FUNCTION

## 1. Introduction

This inverter can be used in parallel for two applications.

1. Parallel operation in single phase with up to 9 units. The supported maximum output power is 27KW/27KVA for 3KW model and 45KW/45KVA for 5KW model.
2. Maximum 9 units work together to support three-phase equipment. Seven units support one phase maximum. For 3KW model, the supported maximum output power is 27KW/27KVA and one phase can be up to 21KW/21KVA. For 5KW model, the supported maximum output power is 45KW/45KVA and one phase can be up to 35KW/35KVA.

**NOTE:** If this unit is bundled with share current cable and parallel cable, this inverter is default supported parallel operation. You may skip section 3. If not, please purchase parallel kit and install this unit by following instruction from professional technical personnel in local dealer.

## 2. Package Contents

In parallel kit, you will find the following items in the package:

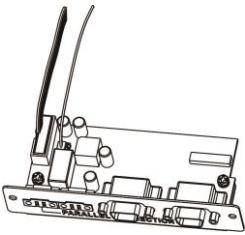

Parallel board



Parallel communication cable



Current sharing cable

## 3. Parallel board installation

**Step 1:** Take out parallel cover by removing two screws as below chart and remove 2-pin and 14-pin cables.

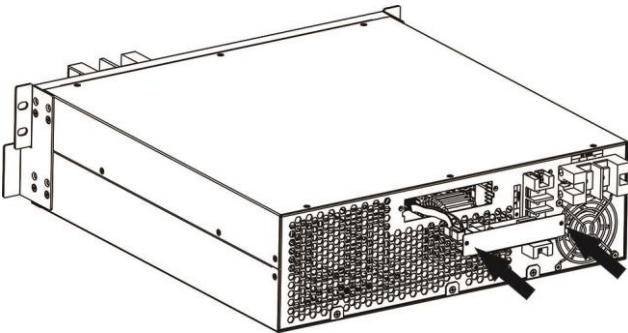

**Step 2:** Replace it with parallel board.

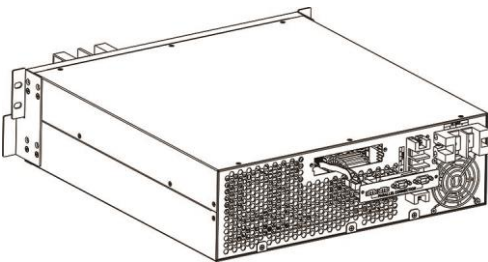

**Step 3:** Re-connect 2-pin and 14-pin to original position on parallel board as shown below chart.

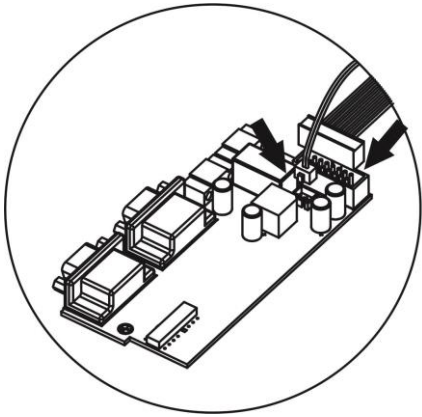

**Step 4:** Put parallel cover back to the unit. Now the inverter is providing parallel operation function.

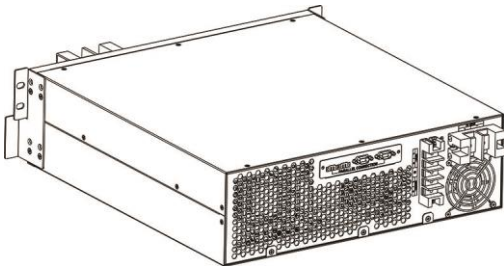

#### 4. Wiring Connection

The cable size of each inverter is shown as below:

**Recommended battery cable and terminal size for each inverter:**

Model	Wire Size	Ring Terminal		Torque value	
		Cable mm <sup>2</sup>	Dimensions		
			D (mm)	L (mm)	
3KW	1*1/0AWG	60	8.4	49.7	4.5 Nm
	2*4AWG	44	8.4	49.7	
5KW	1*1/0AWG	60	8.4	49.7	4.5 Nm
	2 * 4AWG	44	8.4	49.7	

**Ring terminal:**

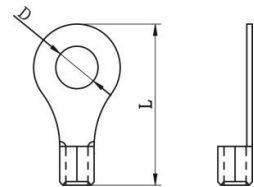

**WARNING:** Be sure the length of all battery cables is the same. Otherwise, there will be voltage difference between inverter and battery to cause parallel inverters not working.

**Recommended AC input and output cable size for each inverter:**

Model	AWG no.	Torque
3KW	10 AWG	1.4~1.6Nm
5KW	8 AWG	1.4~1.6Nm

**CAUTION!! Please make sure the output neutral of each unit is connected together. Otherwise, it may cause the inverter fail.**

You need to connect the cables of each inverter together. Take the battery cables for example: You need to use a connector or bus-bar as a joint to connect the battery cables together, and then connect to the battery terminal. The cable size used from joint to battery should be X times cable size in the tables above. "X" indicates the number of inverters connected in parallel.

Regarding AC input and output, please also follow the same principle.

**CAUTION!!** Please install the breaker at the battery and AC input side. This will ensure the inverter can be securely disconnected during maintenance and fully protected from over current of battery or AC input. The recommended mounted location of the breakers is shown in the figures in 5-1 and 5-2.

**Recommended breaker specification of battery for each inverter:**

Model	1 unit*
3KW	150A/60VDC
5KW	125A/80VDC

\*If you want to use only one breaker at the battery side for the whole system, the rating of the breaker should be X times current of 1 unit. "X" indicates the number of inverters connected in parallel.

**Recommended breaker specification of AC input:**

Model	2 units	3 units	4 units	5 units	6 units	7 units	8 units	9 units
3KW	80A	120A	160A	200A	240A	280A	320A	360A
5KW	100A	150A	200A	250A	300A	350A	400A	450A

**Note1:** Also, you can use 40A breaker for 3KW and 50A for 5KW for only 1 unit and install one breaker at its AC input in each inverter.

**Note2:** Regarding three-phase system, you can use 4-pole breaker directly and the rating of the breaker should be compatible with the phase current limitation from the phase with maximum units

**Recommended battery capacity**

Inverter parallel numbers	2	3	4	5	6	7	8	9
Battery Capacity	800AH	1200AH	1600AH	2000AH	2400AH	2800AH	3200AH	3600AH

**WARNING!** Be sure that all inverters will share the same battery bank. Otherwise, the inverters will transfer to fault mode.

**PV Connection**

Please refer to user manual of single unit for PV Connection.

**CAUTION:** Each inverter should connect to PV modules separately.

### 4-1. Parallel Operation in Single phase

Two inverters in parallel:

#### Power Connection

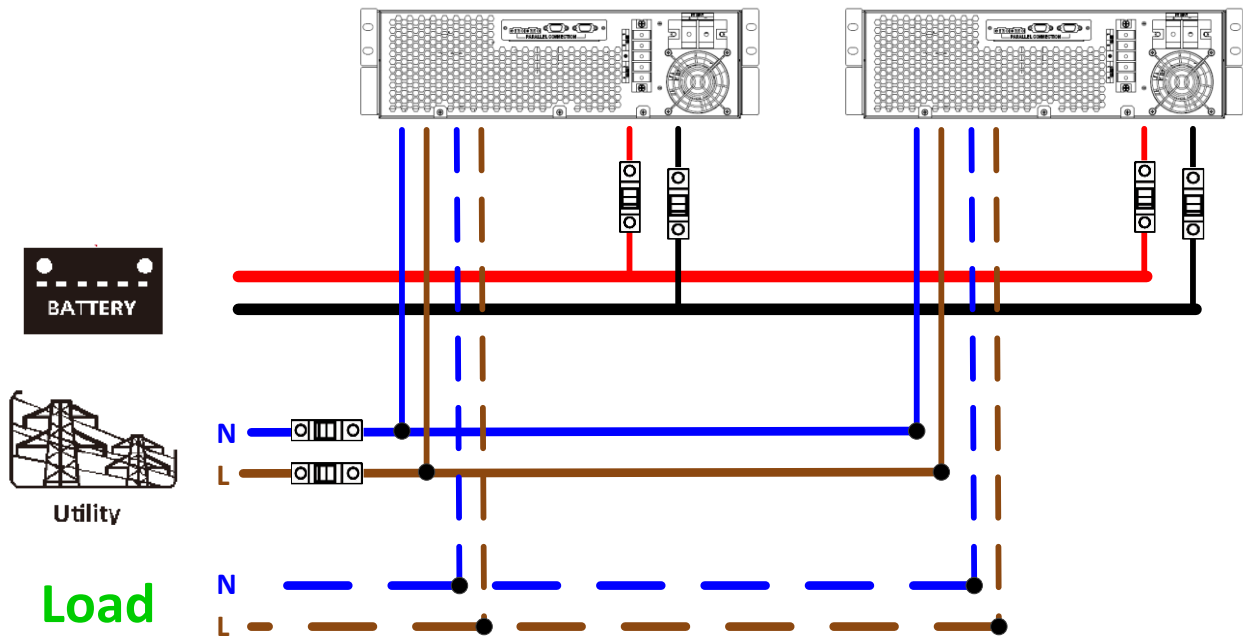

#### Communication Connection

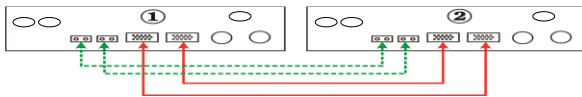

Three inverters in parallel:

#### Power Connection

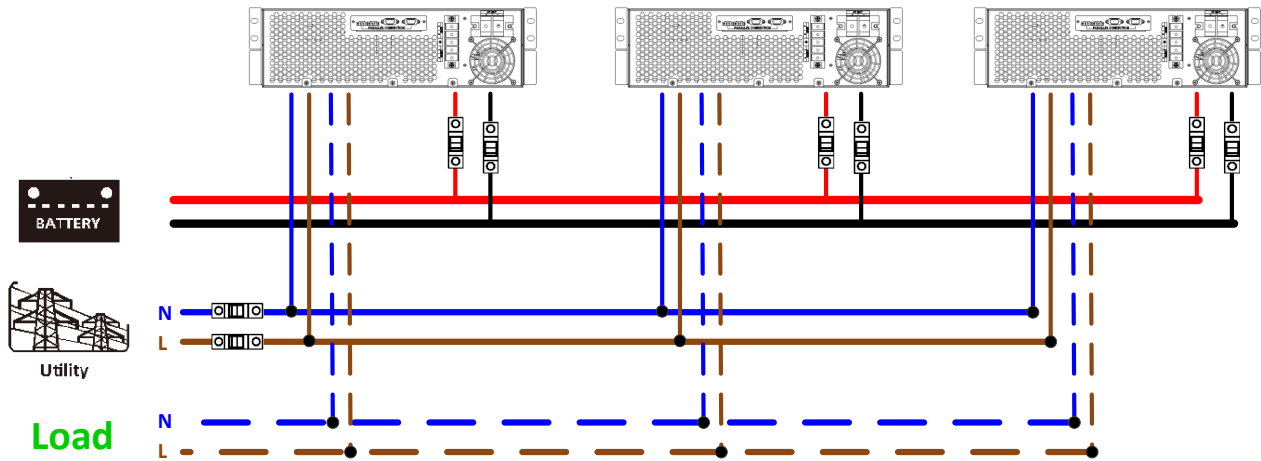

#### Communication Connection

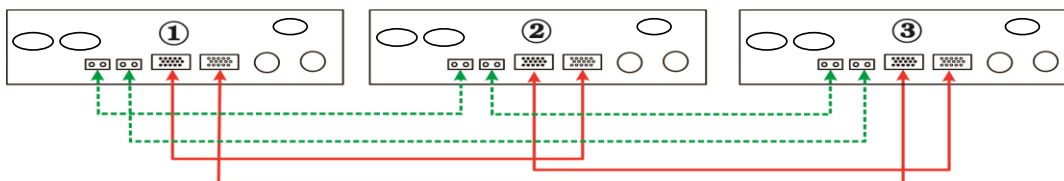

Four inverters in parallel:

### Power Connection

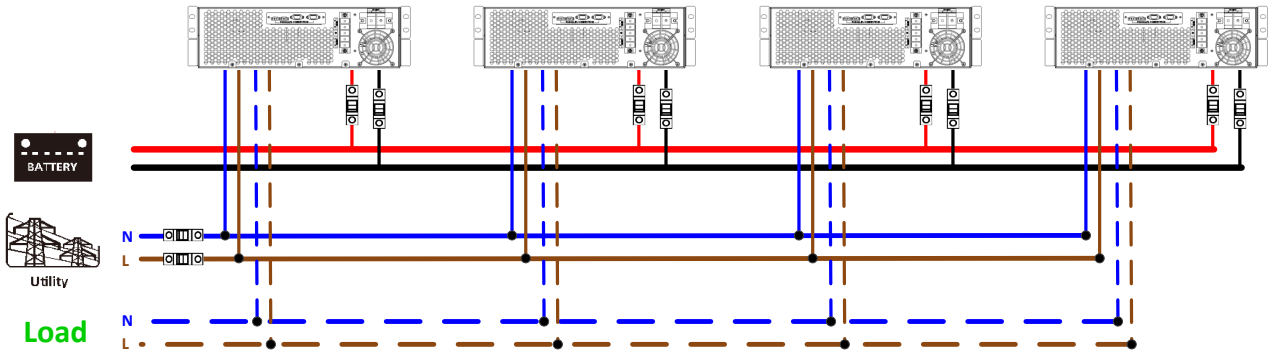

### Communication Connection

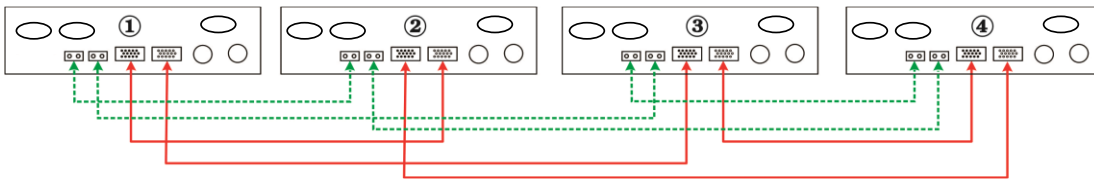

Five inverters in parallel:

### Power Connection

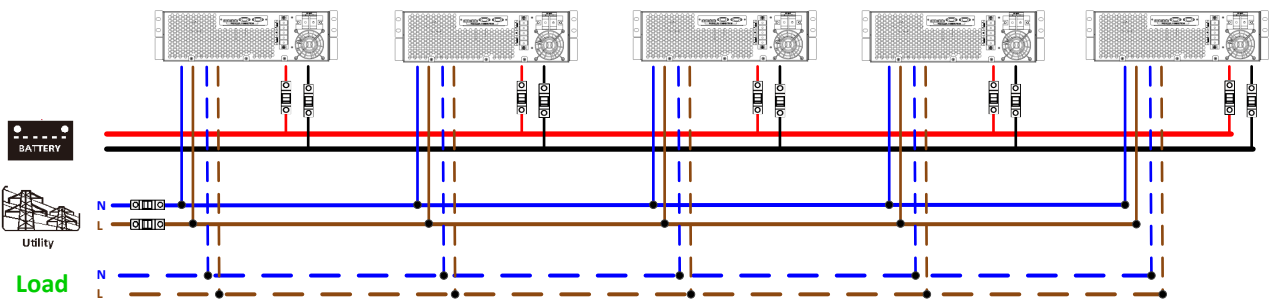

### Communication Connection

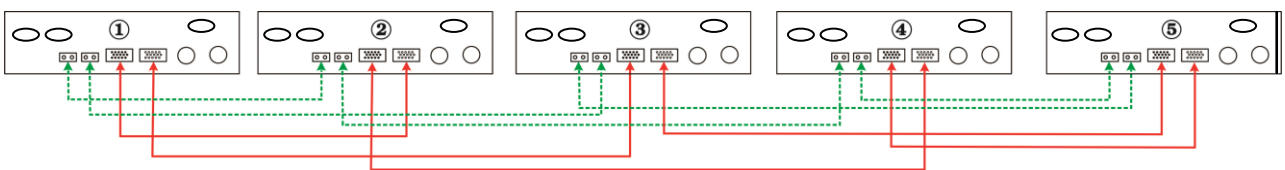

Six inverters in parallel:

### Power Connection

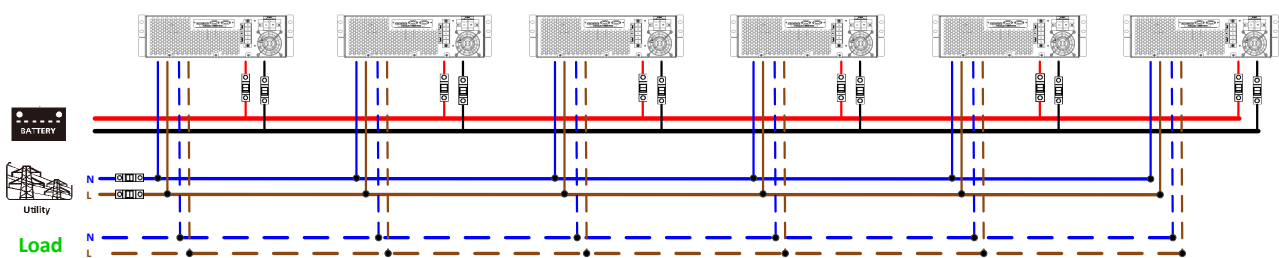

### Communication Connection

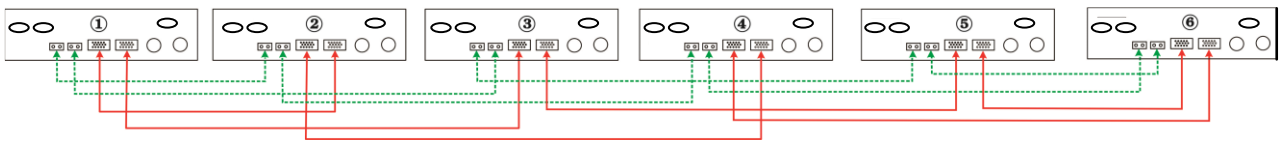

Seven inverters in parallel:

### Power Connection

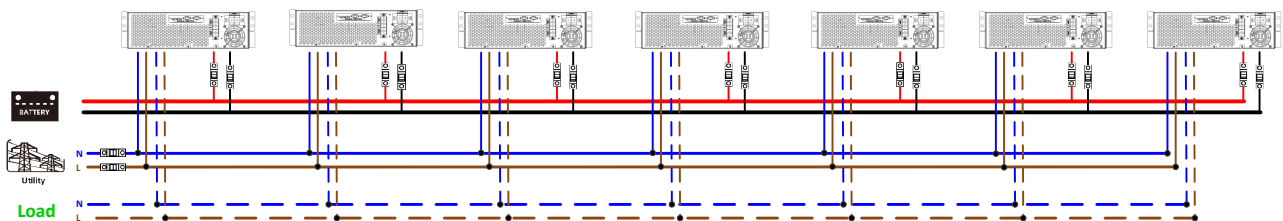

### Communication Connection

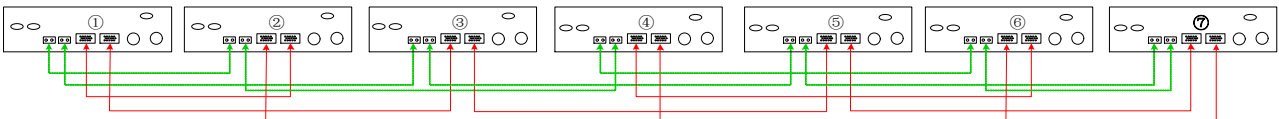

Eight inverters in parallel:

### Power Connection

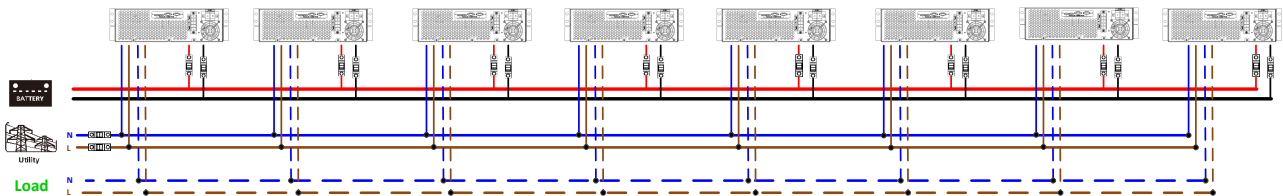

### Communication Connection

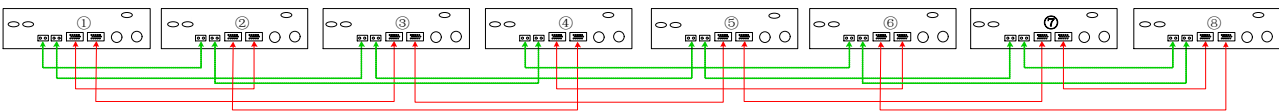

Nine inverters in parallel:

### Power Connection

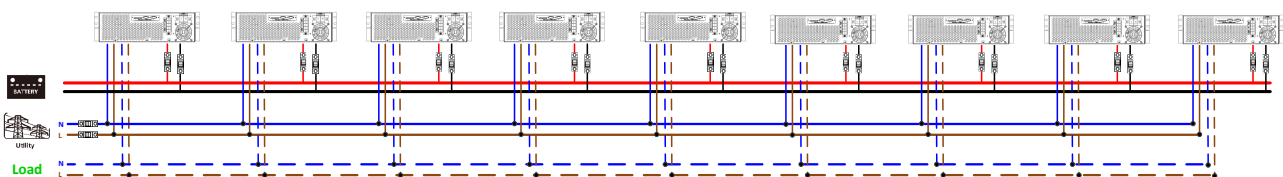

### Communication Connection

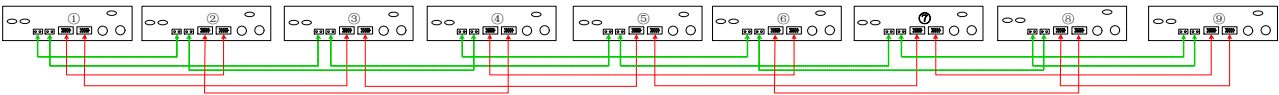

### 4-2. Support 3-phase equipment

Three inverters in each phase:

### Power Connection

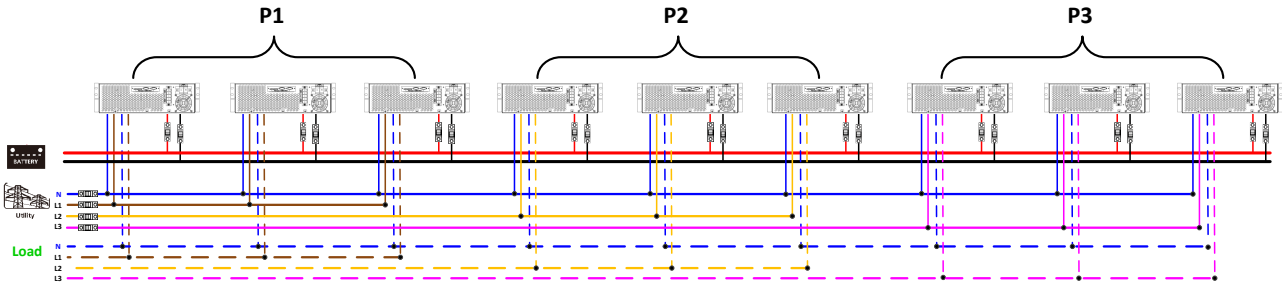

### Communication Connection

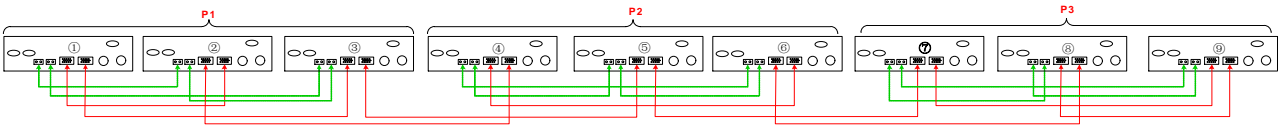

**WARNING:** Do not connect the current sharing cable between the inverters which are in different phases. Otherwise, it may damage the inverters.

Two inverters in each phase:

### Power Connection

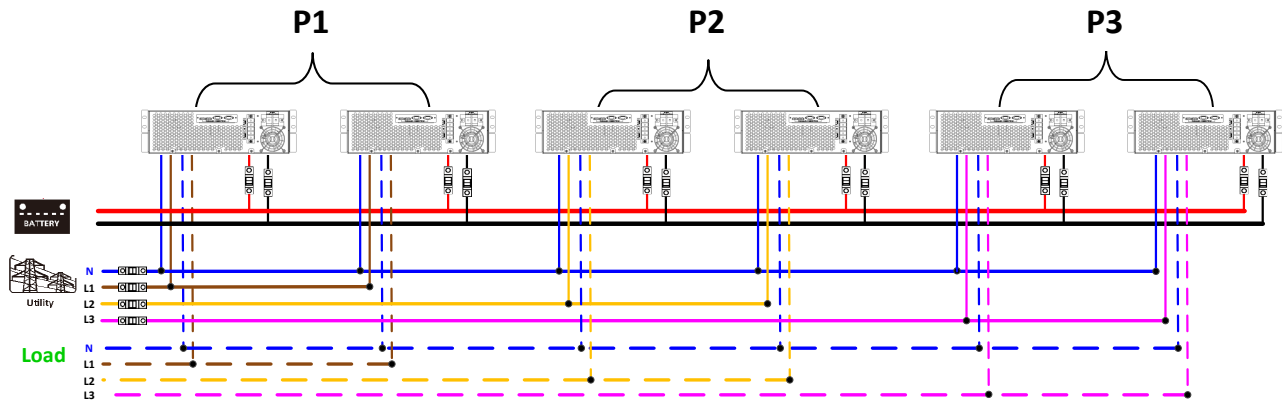

### Communication Connection

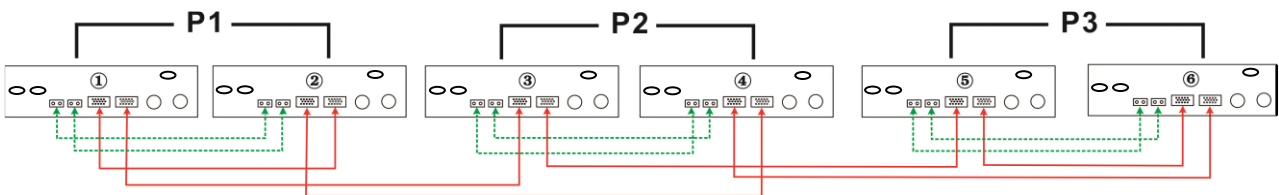

Seven inverters in one phase and one inverter for the other two phases:

**Power Connection**

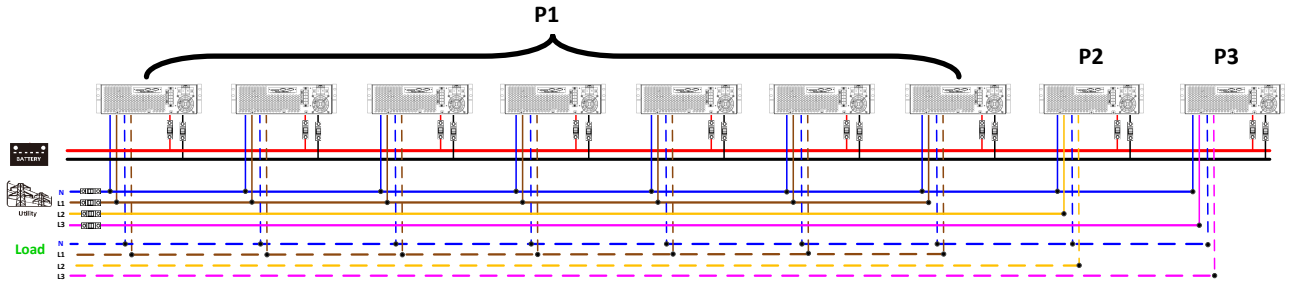

**Note:** It's up to customer's demand to pick 7 inverters on any phase.

P1: L1-phase, P2: L2-phase, P3: L3-phase.

**Communication Connection**

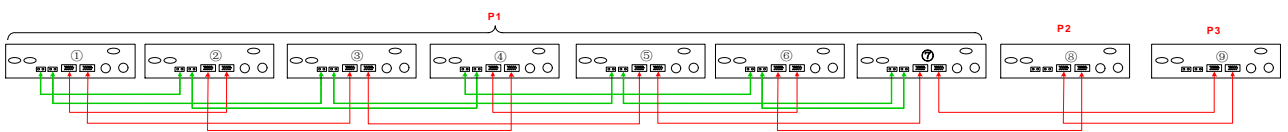

**Note:** If there is only one unit in one phase, this unit doesn't need to connect the current sharing cable.

Or you connect it like as below:

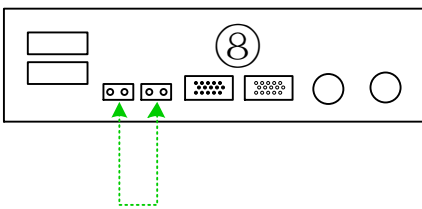

Four inverters in one phase and one inverter for the other two phases:

**Power Connection**

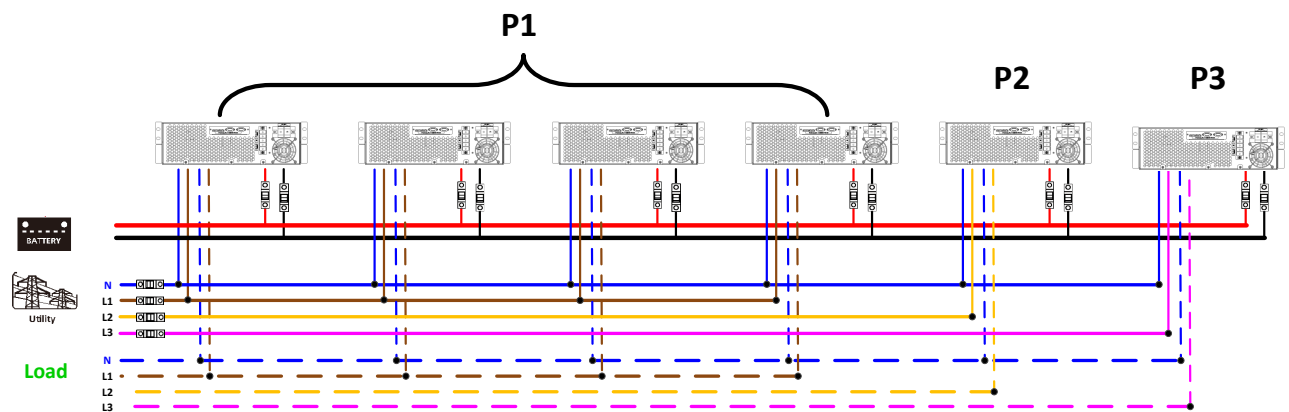

**Note:** It's up to customer's demand to pick 4 inverters on any phase.

P1: L1-phase, P2: L2-phase, P3: L3-phase.



### Communication Connection

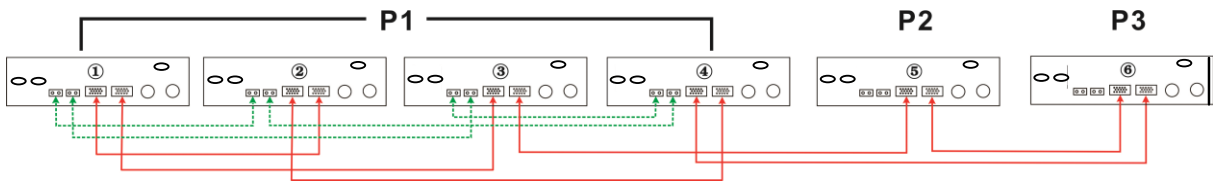

Three inverters in one phase, two inverters in second phase and one inverter for the third phase:

### Power Connection

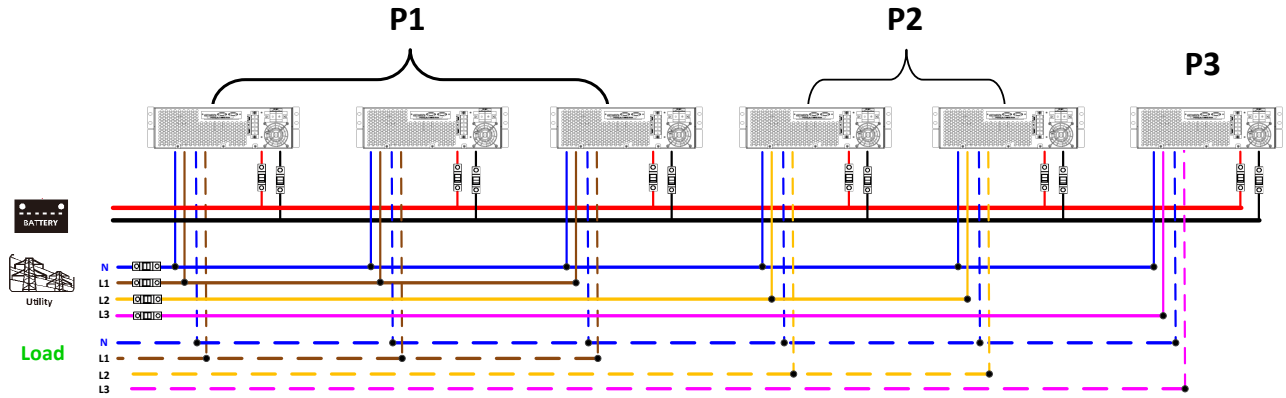

### Communication Connection

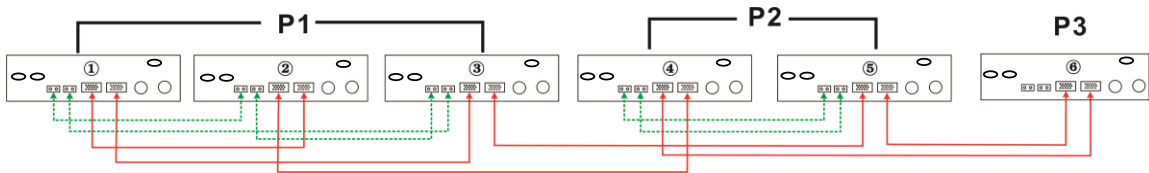

Three inverters in one phase and only one inverter for the remaining two phases:

### Power Connection

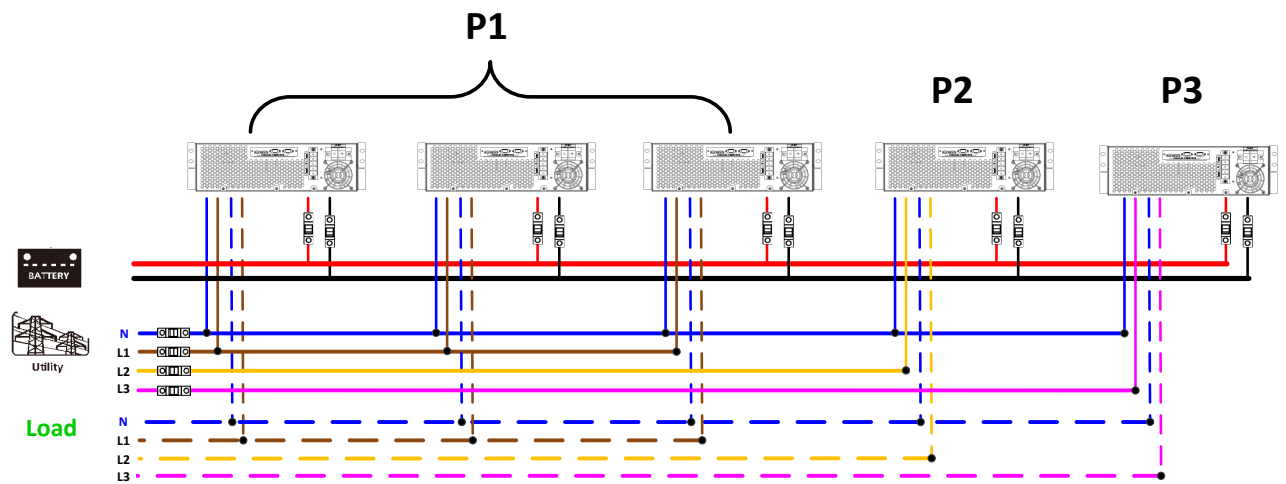

### Communication Connection

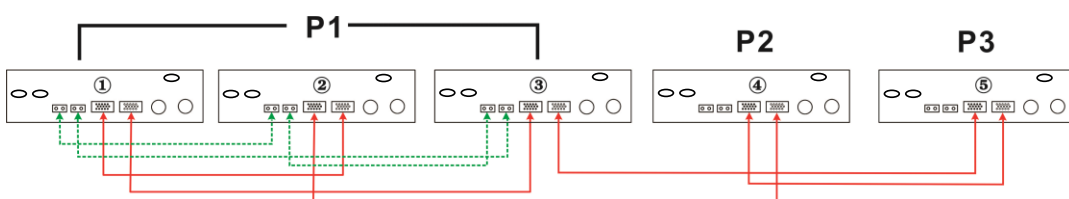

Two inverters in two phases and only one inverter for the remaining phase:

**Power Connection**

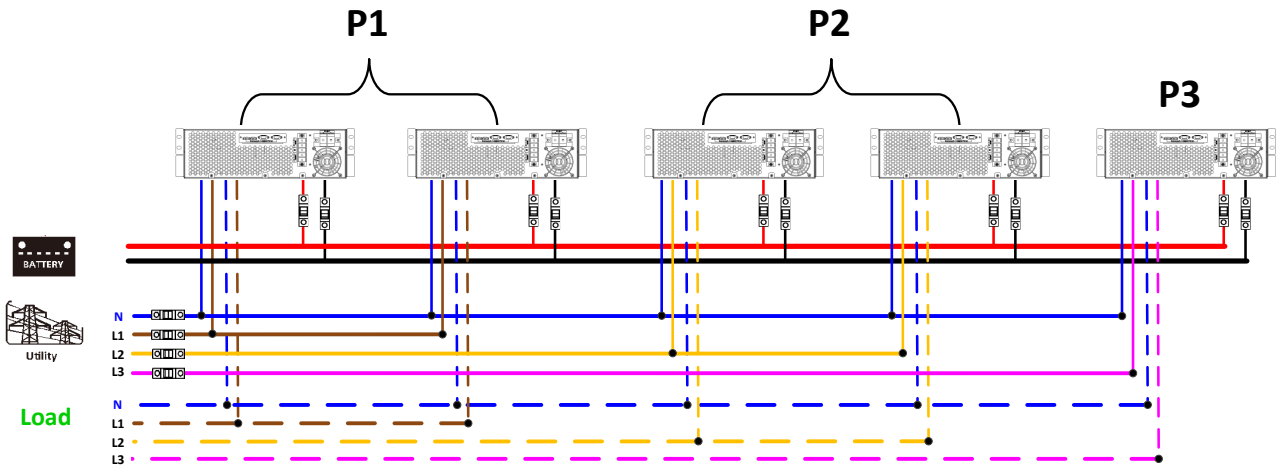

**Communication Connection**

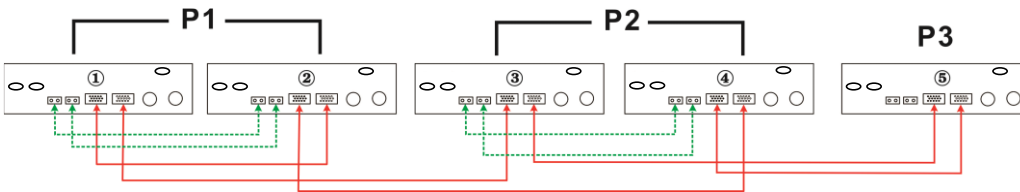

Two inverters in one phase and only one inverter for the remaining phases:

**Power Connection**

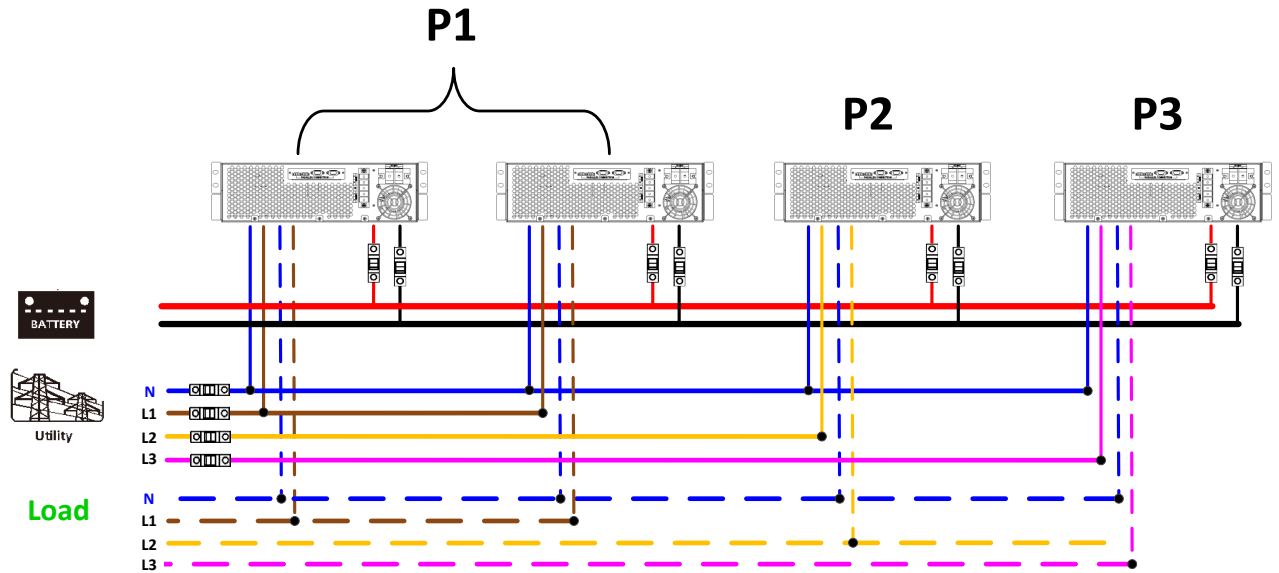

**Communication Connection**

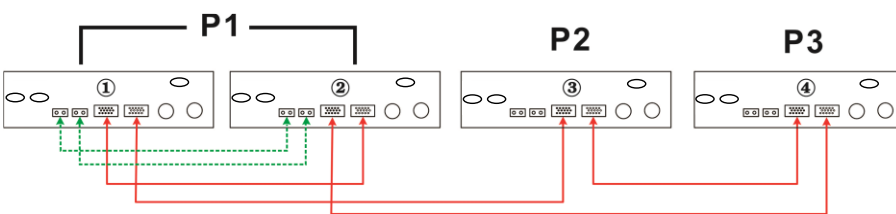

One inverter in each phase:

**Power Connection**

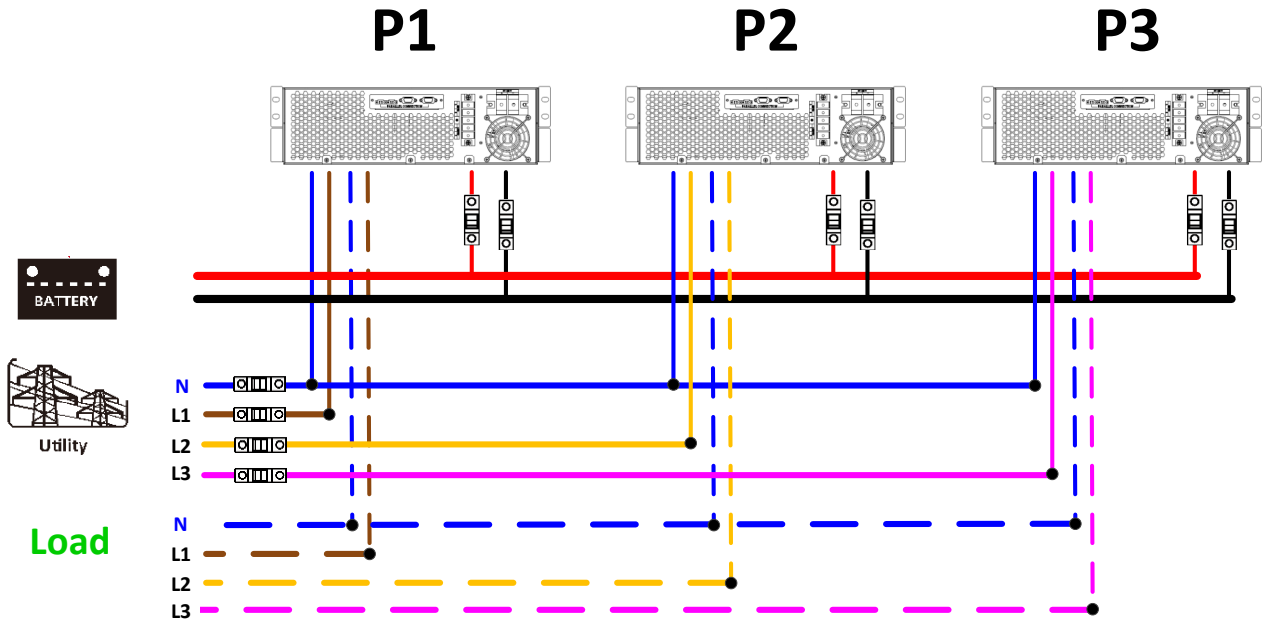

**Communication Connection**

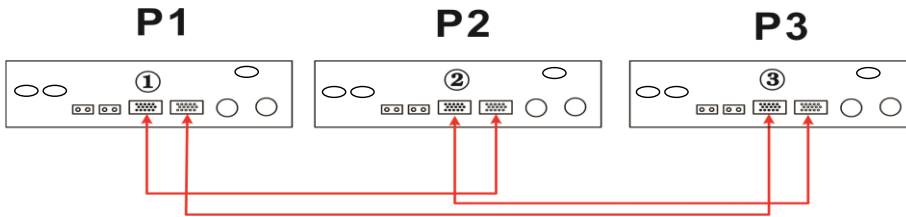



**WARNING:** Do not connect the current sharing cable between the inverters which are in different phases. Otherwise, it may damage the inverters.











**5. LCD Setting and Display**

**Setting Program:**

Program	Description	Selectable option	
28	AC output mode *This setting is able to set up only when the inverter is in standby mode. Be sure that on/off switch is in "OFF" status.	Single: 28 <sup>OUTPUT</sup> SIG	When the unit is operated alone, please select "SIG" in program 28.
		Parallel: 28 <sup>OUTPUT</sup> PAL	When the units are used in parallel for single phase application, please select "PAL" in program 28. Please refer to 5-1 for detailed information.

		<p>L1 phase:  </p>	<p>When the units are operated in 3-phase application, please choose "3PX" to define each inverter.  It is required to have at least 3 inverters or maximum 9 inverters to support three-phase equipment. It's required to have at least one inverter in each phase or it's up to four inverters in one phase. Please refers to 5-2 for detailed information.  Please select "3P1" in program 28 for the inverters connected to L1 phase, "3P2" in program 28 for the inverters connected to L2 phase and "3P3" in program 28 for the inverters connected to L3 phase.</p>
	<p>L2 phase:  </p>		
	<p>L3 phase:  </p>		
			<p>Be sure to connect share current cable to units which are on the same phase.  Do NOT connect share current cable between units on different phases.</p>

**Fault code display:**

Fault Code	Fault Event	Icon on
60	Power feedback protection	
71	Firmware version inconsistent	
72	Current sharing fault	
80	CAN fault	
81	Host loss	
82	Synchronization loss	
83	Battery voltage detected different	
84	AC input voltage and frequency detected different	
85	AC output current unbalance	
86	AC output mode setting is different	

## 6. Commissioning

### Parallel in single phase

Step 1: Check the following requirements before commissioning:

- Correct wire connection
- Ensure all breakers in Line wires of load side are open and each Neutral wires of each unit are connected together.

Step 2: Turn on each unit and set "PAL" in LCD setting program 28 of each unit. And then shut down all units.

**NOET:** It's necessary to turn off switch when setting LCD program. Otherwise, the setting can not be programmed.

Step 3: Turn on each unit.

LCD display in Master unit	LCD display in Slave unit

**NOTE:** Master and slave units are randomly defined.

Step 4: Switch on all AC breakers of Line wires in AC input. It's better to have all inverters connect to utility at the same time. If detecting AC connection, they will work normally.

LCD display in Master unit	LCD display in Slave unit

Step 5: If there is no more fault alarm, the parallel system is completely installed.

Step 6: Please switch on all breakers of Line wires in load side. This system will start to provide power to the load.

### Support three-phase equipment

Step 1: Check the following requirements before commissioning:

- Correct wire connection
- Ensure all breakers in Line wires of load side are open and each Neutral wires of each unit are connected together.

Step 2: Turn on all units and configure LCD program 28 as P1, P2 and P3 sequentially. And then shut down all units.

**NOET:** It's necessary to turn off switch when setting LCD program. Otherwise, the setting can not be programmed.

Step 3: Turn on all units sequentially.

LCD display in L1-phase unit	LCD display in L2-phase unit	LCD display in L3-phase unit

Step 4: Switch on all AC breakers of Line wires in AC input. If AC connection is detected and three phases are matched with unit setting, they will work normally. Otherwise, the AC icon  will flash and they will not work in line mode.

LCD display in L1-phase unit	LCD display in L2-phase unit	LCD display in L3-phase unit

Step 5: If there is no more fault alarm, the system to support 3-phase equipment is completely installed.

Step 6: Please switch on all breakers of Line wires in load side. This system will start to provide power to the load.

Note 1: To avoid overload occurring, before turning on breakers in load side, it's better to have whole system in operation first.

Note 2: Transfer time for this operation exists. Power interruption may happen to critical devices, which cannot bear transfer time.

## 7. Trouble shooting

Situation		Solution
Fault Code	Fault Event Description	
60	Current feedback into the inverter is detected.	<ol style="list-style-type: none"> <li>Restart the inverter.</li> <li>Check if L/N cables are not connected reversely in all inverters.</li> <li>For parallel system in single phase, make sure the sharing are connected in all inverters. For supporting three-phase system, make sure the sharing cables are connected in the inverters in the same phase, and disconnected in the inverters in different phases.</li> <li>If the problem remains, please contact your installer.</li> </ol>
71	The firmware version of each inverter is not the same.	<ol style="list-style-type: none"> <li>Update all inverter firmware to the same version.</li> <li>Check the version of each inverter via LCD setting and make sure the CPU versions are same. If not, please contact your installer to provide the firmware to update.</li> <li>After updating, if the problem still remains, please contact your installer.</li> </ol>
72	The output current of each inverter is different.	<ol style="list-style-type: none"> <li>Check if sharing cables are connected well and restart the inverter.</li> <li>If the problem remains, please contact your installer.</li> </ol>
80	CAN data loss	<ol style="list-style-type: none"> <li>Check if communication cables are connected well and restart the inverter.</li> <li>If the problem remains, please contact your installer.</li> </ol>
81	Host data loss	
82	Synchronization data loss	
83	The battery voltage of each inverter is not the same.	<ol style="list-style-type: none"> <li>Make sure all inverters share same groups of batteries together.</li> <li>Remove all loads and disconnect AC input and PV input. Then, check battery voltage of all inverters. If the values from all inverters are close, please check if all battery cables are the same length and same material type. Otherwise, please contact your installer to provide SOP to calibrate battery voltage of each inverter.</li> <li>If the problem still remains, please contact your installer.</li> </ol>
84	AC input voltage and frequency are detected different.	<ol style="list-style-type: none"> <li>Check the utility wiring connection and restart the inverter.</li> <li>Make sure utility starts up at same time. If there are breakers installed between utility and inverters, please be sure all breakers can be turned on AC input at same time.</li> <li>If the problem remains, please contact your installer.</li> </ol>
85	AC output current unbalance	<ol style="list-style-type: none"> <li>Restart the inverter.</li> <li>Remove some excessive loads and re-check load information from LCD of inverters. If the values are different, please check if AC input and output cables are in the same length and material type.</li> <li>If the problem remains, please contact your installer.</li> </ol>
86	AC output mode setting is different.	<ol style="list-style-type: none"> <li>Switch off the inverter and check LCD setting #28.</li> <li>For parallel system in single phase, make sure no 3P1, 3P2 or 3P3 is set on #28. For supporting three-phase system, make sure no "PAL" is set on #28.</li> <li>If the problem remains, please contact your installer.</li> </ol>

## Appendix A: Approximate Back-up Time Table

Model	Load (VA)	Backup Time @24Vdc 200Ah (min)	Backup Time @24Vdc 400Ah (min)
3KW	300	898	2200
	600	444	1050
	900	249	606
	1200	190	454
	1500	136	328
	1800	112	252
	2100	96	216
	2400	70	188
	2700	62	148
	3000	56	134

Model	Load (VA)	Backup Time @ 48Vdc 200Ah (min)	Backup Time @ 48Vdc 400Ah (min)
5KW	500	1226	2576
	1000	536	1226
	1500	316	804
	2000	222	542
	2500	180	430
	3000	152	364
	3500	130	282
	4000	100	224
	4500	88	200
	5000	80	180

**Note:** Backup time depends on the quality of the battery, age of battery and type of battery.  
Specifications of batteries may vary depending on different manufacturers.

# Appendix B: BMS Communication Installation

## 1. Introduction

If connecting to lithium battery, it is recommended to purchase a custom-made RJ45 communication cable. Please check with your dealer or integrator for details.

This custom-made RJ45 communication cable delivers information and signal between lithium battery and the inverter. These information are listed below:

- Re-configure charging voltage, charging current and battery discharge cut-off voltage according to the lithium battery parameters.
- Have the inverter start or stop charging according to the status of lithium battery.

## 2. Lithium Battery Communication Configuration

### PYLONTECH

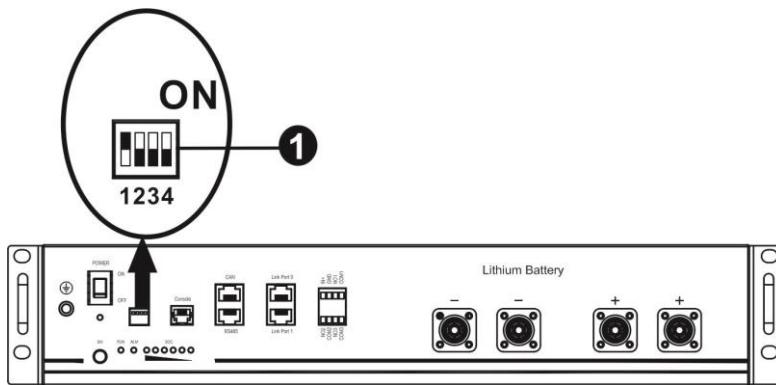

Dip Switch: There are 4 Dip Switches that sets different baud rate and battery group address. If switch position is turned to the "OFF" position, it means "0". If switch position is turned to the "ON" position, it means "1".

Dip 1 is "ON" to represent the baud rate 9600.

Dip 2, 3 and 4 are to set up battery group address.

Dip switch 2, 3 and 4 on master battery (first battery) are to set up or change the group address.

**NOTE:** "1" is upper position and "0" is bottom position.

Dip 1	Dip 2	Dip 3	Dip 4	Group address
1: RS485 baud rate=9600  <b>Restart to take effect</b>	0	0	0	Single group only. It's necessary to set up master battery with this setting and slave batteries are unrestricted.
	1	0	0	Multiple group condition. It's necessary to set up master battery on the first group with this setting and slave batteries are unrestricted.
	0	1	0	Multiple group condition. It's necessary to set up master battery on the second group with this setting and slave batteries are unrestricted.
	1	1	0	Multiple group condition. It's necessary to set up master battery on the third group with this setting and slave batteries are unrestricted.
	0	0	1	Multiple group condition. It's necessary to set up master battery on the fourth group with this setting and slave batteries are unrestricted.
	1	0	1	Multiple group condition. It's necessary to set up master battery on the fifth group with this setting and slave batteries are unrestricted.

**NOTE:** The maximum groups of lithium battery is 5 and for maximum number for each group, please check with battery manufacturer.



### 3. Installation and Operation

#### **PYLONTECH**

After configuration, please install LCD panel with inverter and Lithium battery with the following steps.

Step 1. Use custom-made RJ45 cable to connect inverter and Lithium battery.

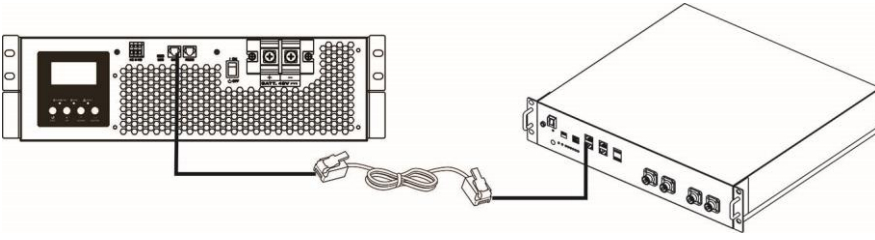

#### **Note for parallel system:**

1. Only support common battery installation.
2. Use custom-made RJ45 cable to connect any inverter (no need to connect to a specific inverter) and Lithium battery. Simply set this inverter battery type to "PYL" in LCD program 5. Others should be "USE".

Step 2. Switch on Lithium battery.

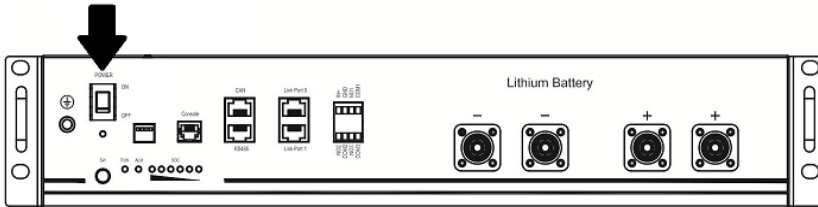

Step 3. Press more than three seconds to start Lithium battery, power output ready.

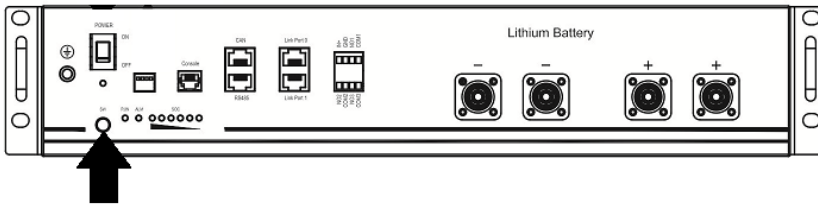

Step 4. Turn on the inverter.

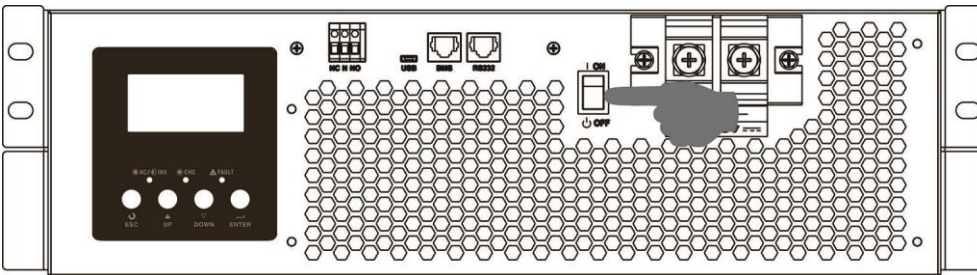

Step 5. Be sure to select battery type as "PYL" in LCD program 5.

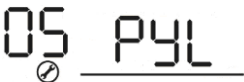

## WECO

Step 1. Use custom-made RJ45 cable to connect inverter and Lithium battery.

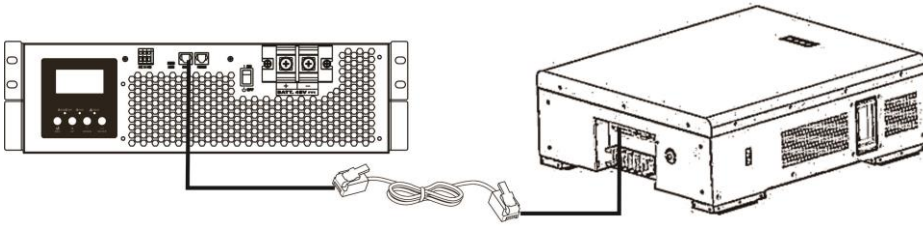

### Note for parallel system:

1. Only support common battery installation.
2. Use custom-made RJ45 cable to connect any inverter (no need to connect to a specific inverter) and Lithium battery. Simply set this inverter battery type to "WEC" in LCD program 5. Others should be "USE".

Step 2. Switch on Lithium battery.

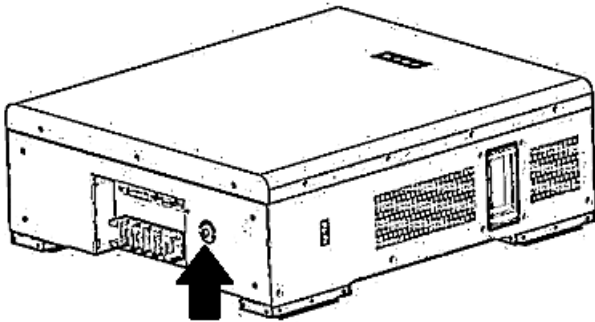

Step 3. Turn on the inverter.

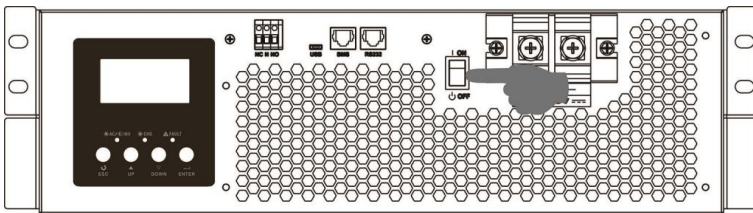

Step 4. Be sure to select battery type as "WEC" in LCD program 5.



## SOLTARO

Step 1. Use custom-made RJ45 cable to connect inverter and Lithium battery.

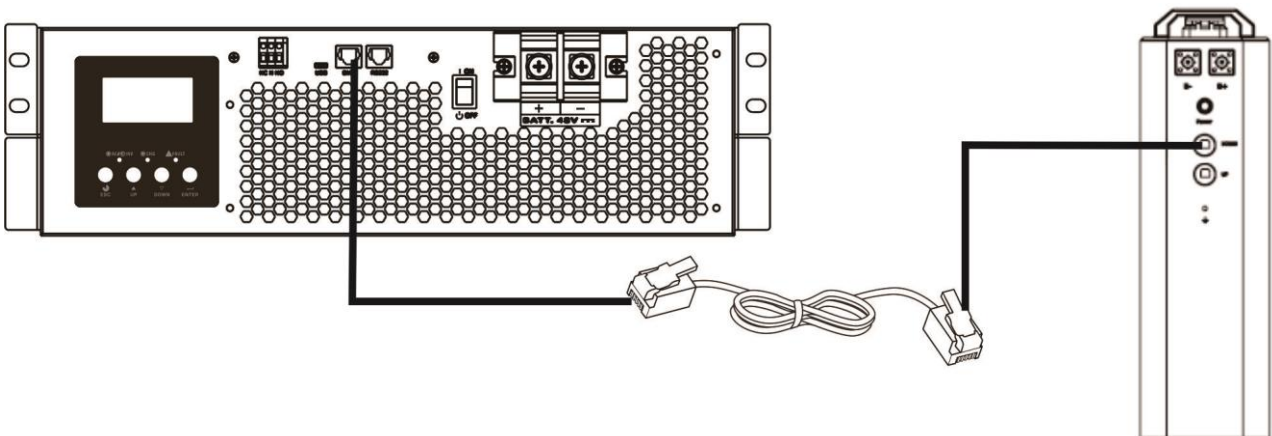

**Note for parallel system:**

1. Only support common battery installation.
2. Use custom-made RJ45 cable to connect any inverter (no need to connect to a specific inverter) and Lithium battery. Simply set this inverter battery type to "SOL" in LCD program 5. Others should be "USE".

Step 2. Open DC isolator and switch on Lithium battery.

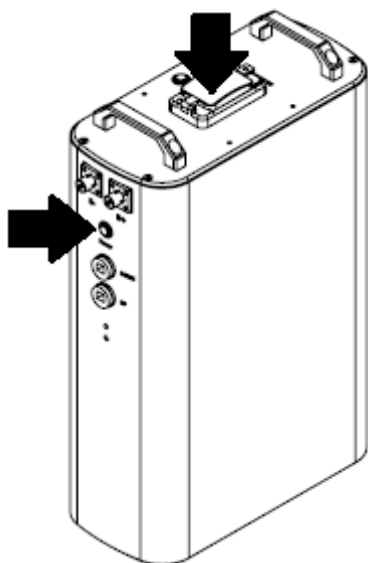

Step 3. Turn on the inverter.

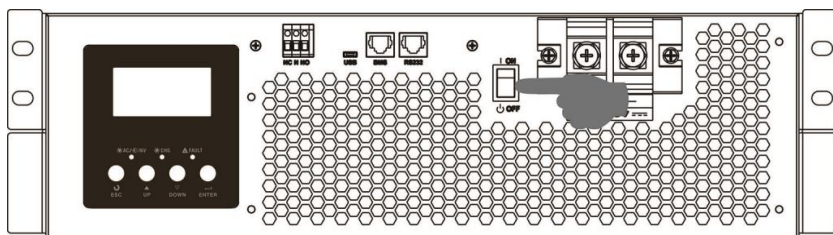

Step 4. Be sure to select battery type as "SOL" in LCD program 5.









**4. LCD Display Information**

Press "UP" or "DOWN" key to switch LCD display information. It will show battery pack and battery group number before "Main CPU version checking" as below screen.

Selectable information	LCD display
Battery pack numbers & Battery group numbers	<p>Battery pack numbers = 3, battery group numbers = 1</p> <p><b>BATT</b> P03 bn <b>BATT</b> 001</p>

## 5. Code Reference

Related information code will be displayed on LCD screen. Please check inverter LCD screen for the operation.

Code	Description	Action
	If battery status is not allowed to charge and discharge after the communication between the inverter and battery is successful, it will show code 60 to stop charging and discharging battery.	
	Communication lost (only available when the battery type is setting as "Pylontech Battery" or "WECO Battery" or "Soltaro Battery" or "BAK Battery".) <ul style="list-style-type: none"> <li>After battery is connected, communication signal is not detected for 3 minutes, buzzer will beep. After 10 minutes, inverter will stop charging and discharging to lithium battery.</li> <li>Communication lost occurs after the inverter and battery is connected successfully, buzzer beeps immediately.</li> </ul>	
	Battery number is changed. It probably is because of communication lost between battery packs.	Press "UP" or "DOWN" key to switch LCD display until below screen shows. It will have battery number re-checked and 62 warning code will be clear. 
	If battery status is not allowed to charge after the communication between the inverter and battery is successful, it will show code 69 to stop charging battery.	
	If battery status must to charge after the communication between the inverter and battery is successful, it will show code 70 to charge battery.	
	If battery status is not allowed to discharge after the communication between the inverter and battery is successful, it will show code 71 to stop charging battery.	