

SUN2000-(12KTL, 15KTL, 17KTL, 20KTL)-M0

User Manual

Issue **04**
Date **2019-10-18**

Copyright © Huawei Technologies Co., Ltd. 2019. All rights reserved.

No part of this document may be reproduced or transmitted in any form or by any means without prior written consent of Huawei Technologies Co., Ltd.

Trademarks and Permissions



HUAWEI and other Huawei trademarks are trademarks of Huawei Technologies Co., Ltd.

All other trademarks and trade names mentioned in this document are the property of their respective holders.

Notice

The purchased products, services and features are stipulated by the contract made between Huawei and the customer. All or part of the products, services and features described in this document may not be within the purchase scope or the usage scope. Unless otherwise specified in the contract, all statements, information, and recommendations in this document are provided "AS IS" without warranties, guarantees or representations of any kind, either express or implied.

The information in this document is subject to change without notice. Every effort has been made in the preparation of this document to ensure accuracy of the contents, but all statements, information, and recommendations in this document do not constitute a warranty of any kind, express or implied.

Huawei Technologies Co., Ltd.

Address: Huawei Industrial Base
Bantian, Longgang
Shenzhen 518129
People's Republic of China

Website: <https://e.huawei.com>

About This Document

Purpose

This document describes the SUN2000-8KTL-M0, SUN2000-10KTL-M0, SUN2000-12KTL-M0, SUN2000-15KTL-M0, SUN2000-17KTL-M0, and SUN2000-20KTL-M0 (SUN2000 for short) in terms of installation, electrical connections, commissioning, maintenance, and troubleshooting. Read this document through, understand the safety information, and get familiar with the functions and features of the SUN2000 before installing and operating it.

NOTE

The SUN2000-8KTL-M0 and SUN2000-10KTL-M0 inverters are applicable only to Australia.





Intended Audience

This document is intended for:

- Installers
- Users

Symbol Conventions

The symbols that may be found in this document are defined as follows.

Symbol	Description
	Indicates a hazard with a high level of risk which, if not avoided, will result in death or serious injury.
	Indicates a hazard with a medium level of risk which, if not avoided, could result in death or serious injury.
	Indicates a hazard with a low level of risk which, if not avoided, could result in minor or moderate injury.
	Indicates a potentially hazardous situation which, if not avoided, could result in equipment damage, data loss, performance deterioration, or unanticipated results. NOTICE is used to address practices not related to personal injury.

Symbol	Description
 NOTE	Supplements the important information in the main text. NOTE is used to address information not related to personal injury, equipment damage, and environment deterioration.

Change History

Changes between document issues are cumulative. The latest document issue contains all updates made in previous issues.

Issue 04 (2019-10-18)

- Updated [5.1 Preparing for Installation](#) and changed the WLAN Smart Dongle to the WLAN-FE Smart Dongle.
- Updated [5.5 \(Optional\) Installing the Smart Dongle](#) and added the installation method of the WLAN-FE Smart Dongle.
- Updated [5.6 \(Optional\) Installing the Signal Cable](#). The Dongle signal cable supports the cascading of multiple inverters.
- Updated [5.6.2 Connecting the RS485 Communications Cable \(Smart Power Sensor\)](#) and added the three-phase three-wire wiring diagram.
- Updated [6.2 Powering On the System](#) and added indicator description about the WLAN-FE Smart Dongle and 4G/GPRS Smart Dongle.
- Updated [6.3 Commissioning](#), modified the scenario names, FusionSolar app download methods, and app screenshots, and added version description about FusionSolar app supported by the WLAN-FE Smart Dongle.
- Updated [C Setting Export Limitation Parameters](#) and modified the screenshots and parameter description.

Issue 03 (2019-07-19)

- Added [E Starting AFCI Check](#).
- Added [F IPS Test \(for Italy CEI0-21 Grid Code only\)](#).
- Added SUN2000-8KTL-M0 and SUN2000-10KTL-M0 inverters are applicable only to Australia.

Issue 02 (2019-06-30)

- Added [C Setting Export Limitation Parameters](#).
- Added [D Setting Voltage Rise Suppression Q-U Curve](#).

Issue 01 (2019-05-08)

This issue is used for first office application (FOA).

Contents

About This Document	ii
1 Safety Precautions	1
2 Overview	4
2.1 Product Introduction	4
2.2 Appearance	8
2.3 Label Description.....	10
2.3.1 Enclosure Labels.....	10
2.3.2 Product Nameplate.....	11
2.4 Working Principles.....	12
2.4.1 Circuit Diagram	12
2.4.2 Working Modes.....	12
3 Storage	15
4 Installation	16
4.1 Checking Before Installation	16
4.2 Tools	16
4.3 Determining the Installation Position	18
4.3.1 Environment Requirements	18
4.3.2 Space Requirements.....	18
4.4 Moving an Inverter	22
4.5 Installing the Mounting Bracket	23
4.5.1 Wall-mounted Installation.....	24
4.5.2 Support-mounted Installation	26
5 Electrical Connections	30
5.1 Preparing for Installation	30
5.2 Connecting the PE cable.....	33
5.3 Connecting the AC Output Power Cable	35
5.4 Connecting the DC input power cable	39
5.5 (Optional) Installing the Smart Dongle.....	44
5.6 (Optional) Installing the Signal Cable	45
5.6.1 Connecting the RS485 Communications Cable (Inverter Cascading)	47
5.6.2 Connecting the RS485 Communications Cable (Smart Power Sensor).....	48

5.6.3 Connecting the Power Grid Scheduling Signal Cable	51
6 Commissioning.....	54
6.1 Check Before Power-On	54
6.2 Powering On the System.....	55
6.3 Commissioning	59
6.3.1 Scenario 1: Smart Dongle Networking Scenario	59
6.3.2 Scenario 2: SmartLogger1000A Networking Scenario	62
6.3.3 Other Scenarios.....	62
6.4 Powering Off the System	64
7 Maintenance	66
7.1 Routine Maintenance	66
7.2 Troubleshooting	67
8 Handling the Inverter.....	75
8.1 Removing the SUN2000.....	75
8.2 Packing the SUN2000.....	75
8.3 Disposing of the SUN2000	75
9 Technical Data	76
A Grid Codes.....	81
B Setting Dry Contact Scheduling Parameters.....	85
C Setting Export Limitation Parameters	87
D Setting Voltage Rise Suppression Q-U Curve	93
E Starting AFCI Check	95
F IPS Test (for Italy CEI0-21 Grid Code only)	96
G Acronyms and Abbreviations.....	99

1 Safety Precautions

Safety

NOTICE

- Before performing operations, read through this manual and follow all the precautions to prevent accidents. The **DANGER**, **WARNING**, **CAUTION**, and **NOTICE** statements in this document do not represent all the safety instructions. They are only supplements to the safety instructions.
- Only certified electricians are allowed to install, connect cables for, commission, maintain, and troubleshoot Huawei products, and they must understand basic safety precautions to avoid hazards.

When operating Huawei equipment, in addition to following the general precautions in this document, follow the specific safety instructions given by Huawei. Huawei will not be liable for any consequence caused by the violation of the safety operation regulations and design, production, and usage standards.

Disclaimer

Huawei shall not be liable for any consequence caused by any of the following events:

- Damage during the transportation by the customer
- Storage conditions that do not meet the requirements specified in this document.
- Incorrect storage, installation, or use
- Installation or use by unqualified personnel
- Failure to follow the operation instructions and safety precautions in this document
- Operation in extreme environments which are not covered in this document
- Operation beyond specified ranges.
- Unauthorized modifications to the product or software code or removal of the product
- Device damage due to force majeure (such as earthquake, fire, and storm)
- Warranty expiration without extension of warranty service.
- Installation or use in environments which are not specified in relevant international standards

Personnel Requirements

- Operation personnel should receive professional training.
- Operation personnel should read through this document and follow all the precautions.
- Operation personnel should be familiar with the safety standards relevant to electrical systems.
- Operation personnel should understand the composition and working principles of the grid-tied PV system and be aware of local regulations.
- Operation personnel must wear proper personal protective equipment (PPE).

Protecting Labels

Do not scrawl, damage, or block any warning label on the device.

Installation

DANGER

Never power on the SUN2000 during installation.

- Ensure that the SUN2000 is not connected to a power supply or powered on before finishing installation.
- Ensure that the SUN2000 is installed in a well-ventilated environment.
- Ensure that the SUN2000 heat sinks are free from blockage.
- Do not open the front panel of the SUN2000.
- Do not remove the terminals and ports at the bottom of the SUN2000.

Grounding

- When installing the device, always make the ground connection first and disconnect it in the end.
- Do not damage the ground conductor.

Electrical Connections

DANGER

Before connecting cables, ensure that the SUN2000 is secured in position and not damaged in any way. Otherwise, electric shock or fire may occur.

- Ensure that all electrical connections comply with local electrical standards.
- Obtain approval from the local utility company before using the SUN2000 to generate electricity in grid-tied mode.
- Ensure that the cables used in a grid-tied PV system are properly connected and insulated and meet all specification requirements.

Operation

DANGER

High voltage may cause an electric shock, which results in serious property damage, serious injury, or death from the SUN2000 in operation. Strictly comply with the safety precautions in this document and associated documents when operating the SUN2000.

- Before operating a device, ensure that it is properly grounded.
- Do not touch an energized SUN2000 because the heat sink reaches a high temperature.
- Follow local laws and regulations when operating the equipment.

Commissioning

When the SUN2000 is powered on for the first time, only qualified personnel are allowed to set the parameters on **Quick Setting**. Incorrect settings may cause the SUN2000 to conflict with the local certification, which affects the normal operation of the SUN2000.

Maintenance and Replacement

DANGER

High voltage may cause an electric shock, which results in serious property damage, serious injury, or death, or serious property damage from the SUN2000 in operation. Prior to maintenance, power off the SUN2000 and strictly comply with the safety precautions in this document and associated documents when operating the SUN2000.

- A faulty SUN2000 requires overall maintenance. Contact your dealer if the SUN2000 is faulty.
- Maintain the SUN2000 with sufficient knowledge of this document, proper tools, and testing equipment.
- Before maintaining the SUN2000, power it off and follow the instructions on the delay discharge label. Wait for a proper time to operate the SUN2000.
- Place temporary warning signs or erect fences to prevent unauthorized access to the maintenance site.
- Rectify any fault that may compromise the SUN2000 security performance before powering it on again.
- Observe ESD precautions during maintenance.

2 Overview

2.1 Product Introduction

Function

The SUN2000 is a three-phase grid-tied PV string inverter that converts the DC power generated by PV strings into AC power and feeds the power into the power grid.

Models

This document involves the following product models:

- SUN2000-8KTL-M0
- SUN2000-10KTL-M0
- SUN2000-12KTL-M0
- SUN2000-15KTL-M0
- SUN2000-17KTL-M0
- SUN2000-20KTL-M0

NOTE

The SUN2000-8KTL-M0 and SUN2000-10KTL-M0 inverters are applicable only to Australia.

Figure 2-1 Model description (SUN2000-20KTL-M0 is used as an example)

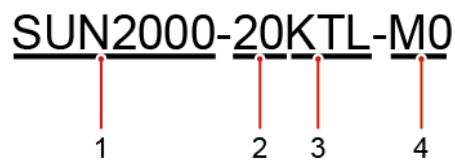

Table 2-1 Model description

Icon	Meaning	Description
1	Product	SUN2000: three-phase grid-tied PV string inverter

Icon	Meaning	Description
2	Power level	<ul style="list-style-type: none"> • 8K: The rated power is 8 kW. • 10K: The rated power is 10 kW. • 12K: The rated power is 12 kW. • 15K: The rated power is 15 kW. • 17K: The rated power is 17 kW. • 20K: The rated power is 20 kW.
3	Topology	TL: transformerless
4	Product code	M0: the product series with the 1100 V DC input voltage

Network Application

The SUN2000 applies to grid-tied PV systems for residential rooftops and small ground plants. Typically, a grid-tied system consists of the PV string, SUN2000, AC switch, and alternating current distribution unit (ACDU).

Figure 2-2 Networking application - Single inverter scenario (optional in dashed boxes)

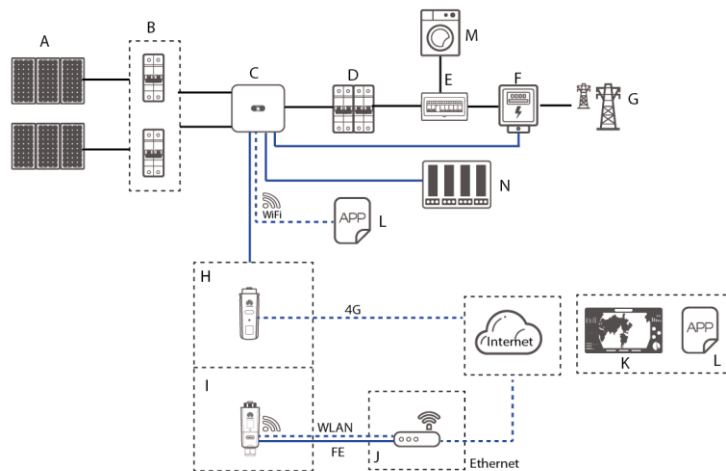
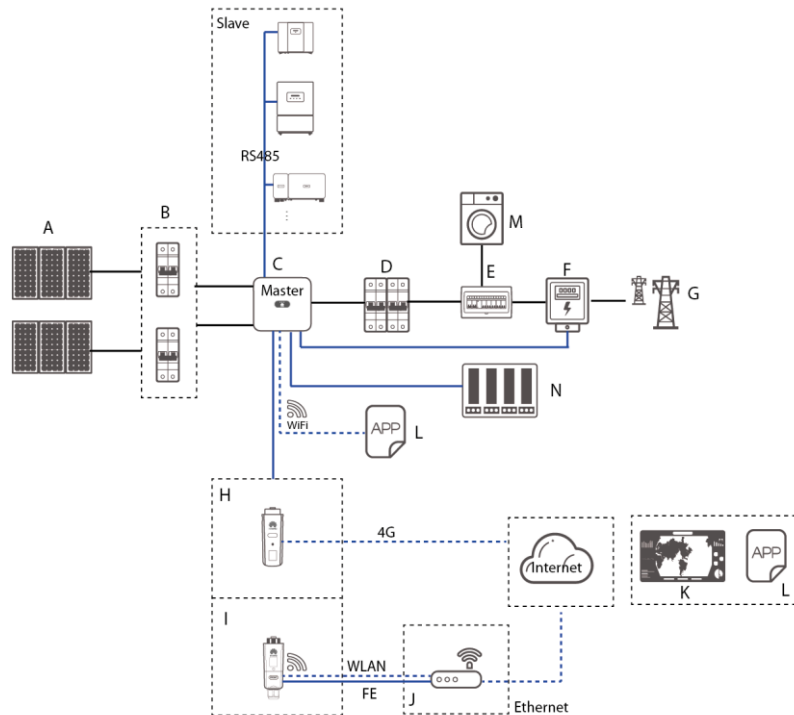

Figure 2-3 Networking application - Inverter cascading scenario (optional in dashed boxes)



NOTE

- indicates a power cable, — indicates a signal cable, indicates wireless communication.
- If the inverter is connected to the FusionSolar app over its built-in WiFi network, only local commissioning can be performed.
- In the RS485 cascading communication networking, the master inverter model is SUN2000-(3KTL-20KTL)-M0, and the slave inverter model can be SUN2000-(3KTL-20KTL)-M0, SUN2000-50KTL/60KTL-M0, SUN2000-29.9KTL/36KTL, or SUN2000-33KTL-A.

(A) PV string	(B) DC switch	(C) SUN2000
(D) AC switch	(E) ACDU	(F) Smart Power Sensor
(G) Power grid	(H) 4G Smart Dongle	(I) WLAN-FE Smart Dongle
(J) Router	(K) FusionSolar management system	(L) FusionSolar APP
(M) Load	(N) Ripple Control Device	

Supported Power Grids

Power grid types supported by the SUN2000 include TN-S, TN-C, TN-C-S, TT, and IT.

Figure 2-4 Supported power grids

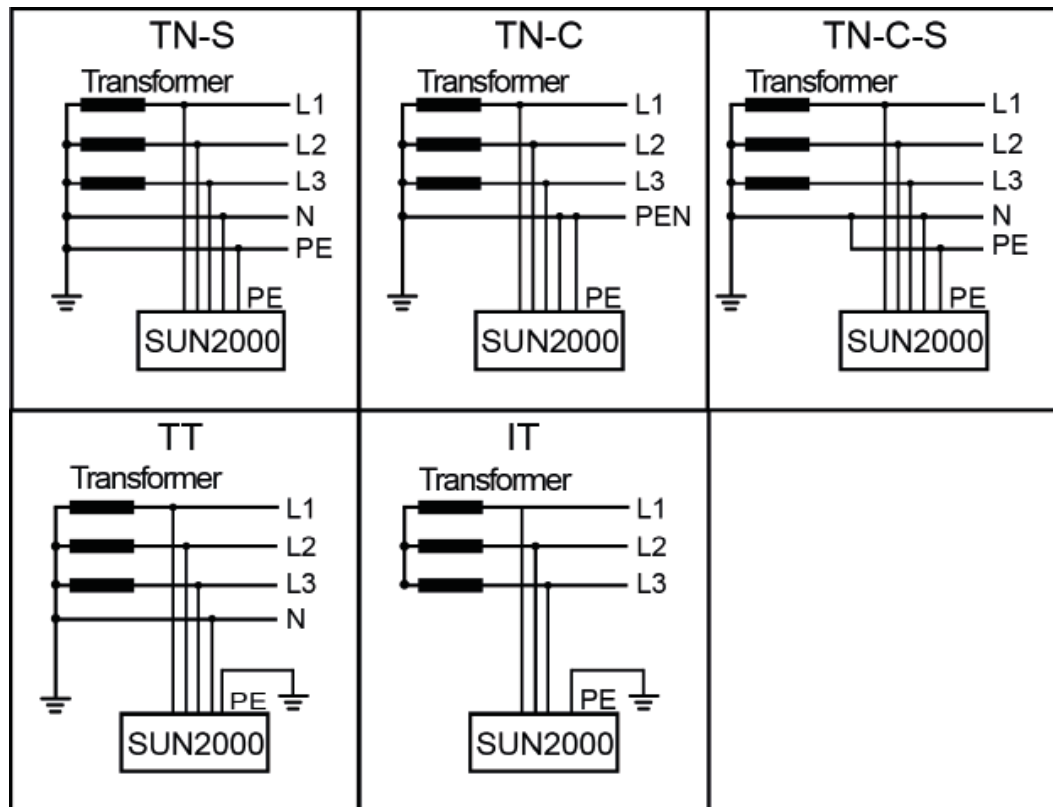

IS01S10001

NOTE

- In a TT power grid, the N-PE voltage should be lower than 30 V.
- In an IT power grid, you need to set **isolation settings** to **input not grounded, with a transformer**.

2.2 Appearance

Figure 2-5 Appearance

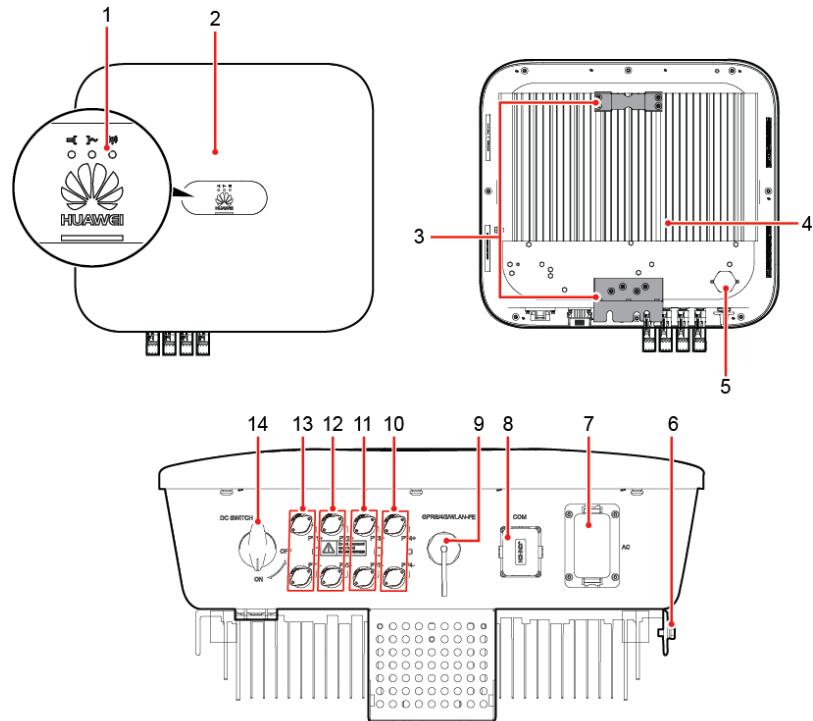

- | | |
|---|-------------------------------------|
| (1) LED indicator | (2) Front panel |
| (3) Mounting plate | (4) Heat sink |
| (5) Ventilation valve | (6) Ground screw |
| (7) AC output port (AC) | (8) Communication port (COM) |
| (9) Smart Dongle port (GPRS/4G/WLAN-FE) | (10) DC input terminals (PV4+/PV4-) |
| (11) DC input terminals (PV3+/PV3-) | (12) DC input terminals (PV2+/PV2-) |
| (13) DC input terminals (PV1+/PV1-) | (14) DC switch (DC SWITCH) |

NOTE

Two M6 screw holes are reserved on both left and right sides of the enclosure for installing an awning.





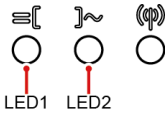
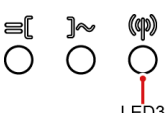
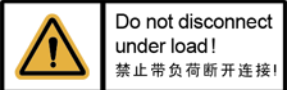

Table 2-2 LED indicator description



Category	Status		Meaning
	LED1	LED2	
Running	LED1	LED2	N/A

Category	Status		Meaning
indication  LED1 LED2	Steady green	Steady green	The SUN2000 is operating in grid-tied mode.
	Blinking green at long intervals (on for 1s and then off for 1s)	Off	The DC is on and the AC is off.
	Blinking green at long intervals (on for 1s and then off for 1s)	Blinking green at long intervals (on for 1s and then off for 1s)	The DC is on, the AC is on, and the SUN2000 is not exporting power to the power grid.
	Off	Off	The DC is off. ^a
	Blinking red at short intervals (on for 0.2s and then off for 0.2s)	N/A	DC environmental alarm
	N/A	Blinking red at short intervals (on for 0.2s and then off for 0.2s)	AC environmental alarm
	Steady red	Steady red	Fault
Communication indication  LED3	LED3		N/A
	Blinking green at short intervals (on for 0.2s and then off for 0.2s)		Communication is in progress. (When a mobile phone is connected to the SUN2000, the indicator first indicates that the phone is connected to the SUN2000): blinks green at long intervals.)
	Blinking green at long intervals (on for 1s and then off for 1s)		The mobile phone is connected to the SUN2000.
Off		There is no communication.	
Note a: The AC may be on. Check whether the external AC switch is OFF.			

2.3 Label Description

2.3.1 Enclosure Labels

Symbol	Name	Meaning
 <p>Danger: High Voltage! 高压危险! Start maintaining the SUN2000 at least 5 minutes after the SUN2000 disconnects from all external power supplies. 逆变器与外部所有电源断开后需要等待至少5分钟, 才可以进行维护。</p>	Delayed discharge	Residual voltage exists after the SUN2000 is powered off. It takes 5 minutes for the SUN2000 to discharge to the safe voltage.
 <p>Warning: High Temperature! 高温危险! Never touch the enclosure of an operating SUN2000. 逆变器工作时严禁触摸外壳。</p>	Burn warning	Do not touch an operating SUN2000 because it generates high temperatures on the shell.
 <p>Danger: Electrical Hazard! 有电危险! Only certified professionals are allowed to install and operate the SUN2000. 仅有资质的专业人员才可进行逆变器的安装和操作。 High touch current, earth connection essential before connecting supply. 大接触电流! 接通电源前须先接地。</p>	Electric shock warning label	<ul style="list-style-type: none"> High voltage exists after the SUN2000 is powered on. Only qualified and trained electrical technicians are allowed to perform operations on the SUN2000. High touch current exists after the SUN2000 is powered on. Ensure that the SUN2000 has been grounded before powering on it.
 <p>CAUTION Read instructions carefully before performing any operation on the SUN2000. 对逆变器进行任何操作前, 请仔细阅读说明书!</p>	Refer to documentation	Reminds operators to refer to the documents shipped with the SUN2000.
	Grounding	Indicates the position for connecting the protective earthing (PE) cable.
 <p>Do not disconnect under load! 禁止带负荷断开连接!</p>	Operation warning	Do not remove the DC input connector or the AC output connector when the SUN2000 is running.
 <p>(1P)PN/ITEM:XXXXXXXXX (32P)Model: SUN2000-XKTL-M0 (S)SN:XXXXXXXXXXXXX MADE IN CHINA</p>	SUN2000 serial number (SN) label	Indicates the SUN2000 SN.

Symbol	Name	Meaning
 MAC: xxxxxxxxxxxx	SUN2000 MAC address label	Indicates the MAC address.
	QR code label for SUN2000 WiFi connection	Scan the QR code to connect to Huawei SUN2000 WiFi network.

2.3.2 Product Nameplate

Figure 2-6 Nameplate (SUN2000-20KTL-M0 as an example)

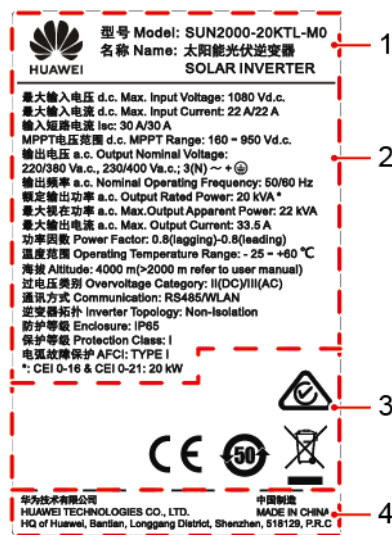

(1) Trademark and product model



(2) Important technical specifications



(3) Compliance symbols

(4) Company name and country of manufacture

NOTE

The nameplate figure is for reference only.

Symbol	Name	Meaning
	Australia RCM certification mark	This product complies with Australia RCM certification standards.
	Conformité Européenne (CE) certification mark	This product complies with CE certification standards.

Symbol	Name	Meaning
	Environmentally friendly use period (EFUP) mark	The product does not pollute the environment during the specified period.
	EU waste electrical and electronic equipment (WEEE) mark	Do not dispose of the product as household garbage.

2.4 Working Principles

2.4.1 Circuit Diagram

Four PV strings connect to the SUN2000, and their maximum power points are tracked by two maximum power point tracking (MPPT) circuits. The SUN2000 converts DC power into three-phase AC power through an inverter circuit. Surge protection is supported on both the DC and AC sides.

Figure 2-7 SUN2000 conceptual diagram

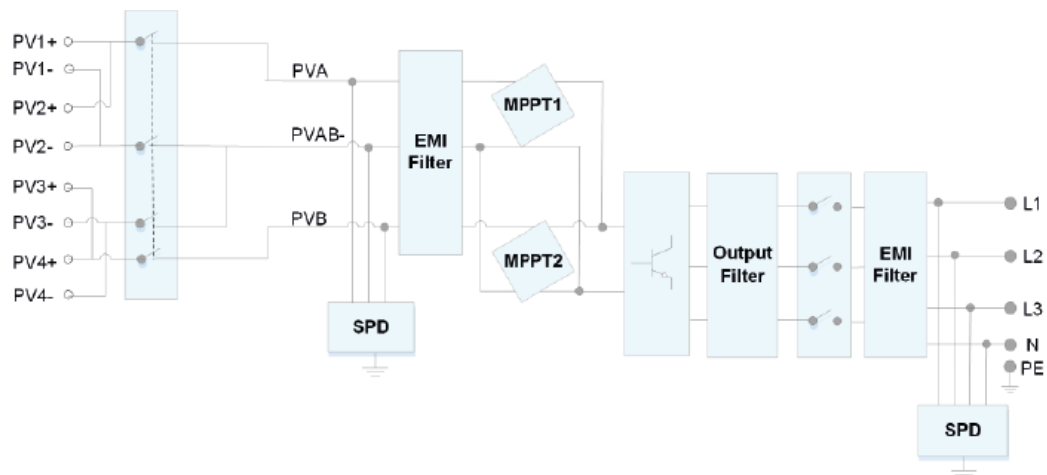

2.4.2 Working Modes

The SUN2000 can work in Standby, Operating, or Shutdown mode.

Figure 2-8 Working modes

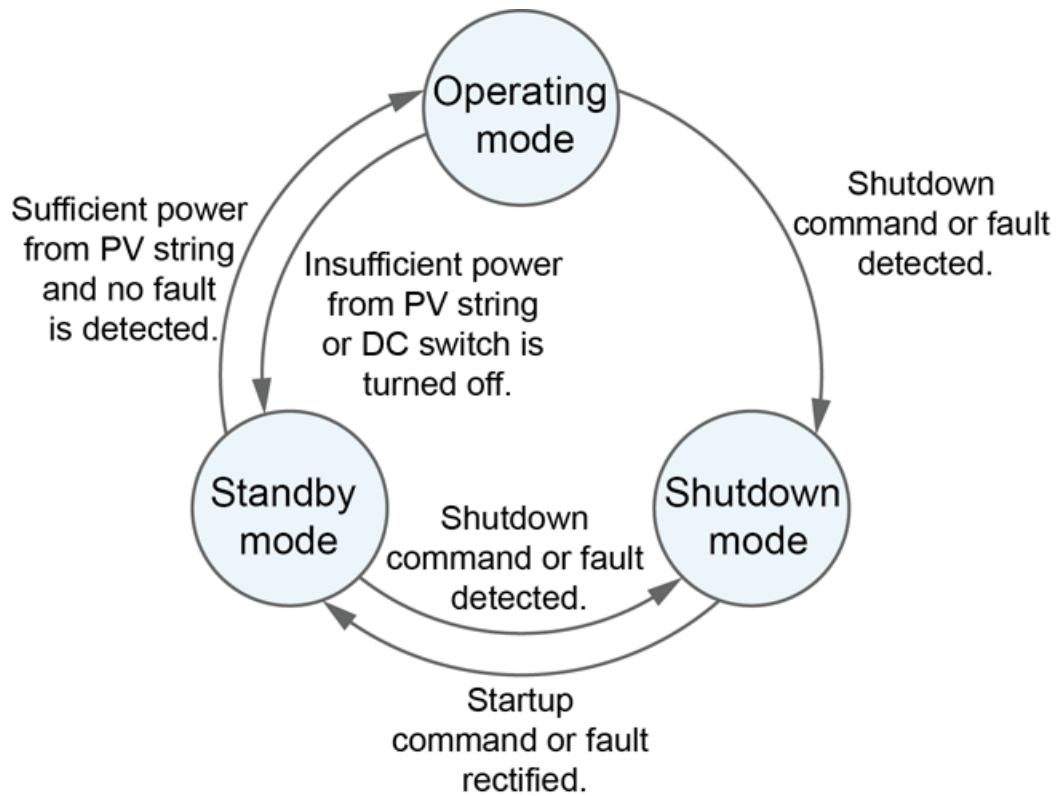

IS07S00001

Table 2-3 Working mode description

Working Mode	Description
Standby	The SUN2000 enters Standby mode when the external environment does not meet the operating requirements. In Standby mode: <ul style="list-style-type: none"> • The SUN2000 continuously performs status check and enters the Operating mode once the operating requirements are met. • The SUN2000 enters Shutdown mode after detecting a shutdown command or a fault after startup.
Operating	In Operating mode: <ul style="list-style-type: none"> • The SUN2000 converts DC power from PV strings into AC power and feeds the power to the power grid. • The SUN2000 tracks the maximum power point to maximize the PV string output. • If the SUN2000 detects a fault or a shutdown command, it enters the Shutdown mode. • The SUN2000 enters Standby mode after detecting that the PV string output power is not suitable for connecting to the power grid for generating power.

Working Mode	Description
Shutdown	<ul style="list-style-type: none">• In Standby or Operating mode, the SUN2000 enters Shutdown mode after detecting a fault or shutdown command.• In Shutdown mode, the SUN2000 enters Standby mode after detecting a startup command or that the fault is rectified.

3 Storage

The following requirements should be met if the SUN2000 is not put into use directly:

- Do not unpack the SUN2000.
- Keep the storage temperature at $-40\text{ }^{\circ}\text{C}$ to $+70\text{ }^{\circ}\text{C}$ and the humidity at 5%–95% RH (non-condensing).
- The SUN2000 should be stored in a clean and dry place and be protected from dust and water vapor corrosion.
- A maximum of six SUN2000s can be stacked. To avoid personal injury or device damage, stack SUN2000s with caution to prevent them from falling over.
- Periodic inspections are required during the storage. Replace the packing materials if necessary.
- If the SUN2000 has been long-term stored, inspections and tests should be conducted by qualified personnel before it is put into use.

4 Installation

4.1 Checking Before Installation

Outer Packing Materials

Before unpacking the inverter, check the outer packing materials for damage, such as holes and cracks, and check the inverter model. If any damage is found or the inverter model is not what you requested, do not unpack the package and contact your supplier as soon as possible.

 **NOTE**

You are advised to remove the packing materials within 24 hours before installing the inverter.

Package Contents









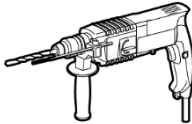
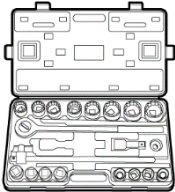
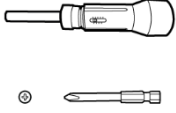
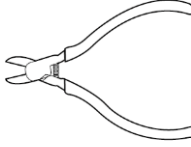

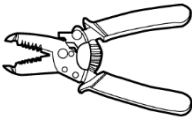
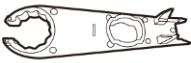

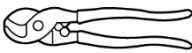
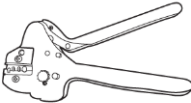

After unpacking the inverter, check that the contents are intact and complete. If any damage is found or any component is missing, contact your supplier.

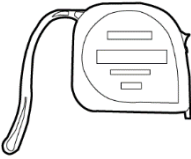
 **NOTE**

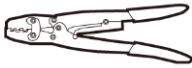
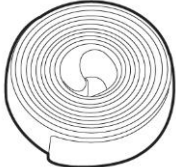
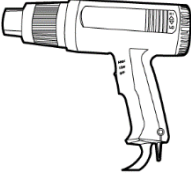
For details about the number of contents, see the *Packing List* in the packing case.

4.2 Tools

Type	Tool			
Installation Tools	 <p>Hammer drill Drill bit: $\Phi 8$ mm and $\Phi 6$ mm</p>	 <p>Socket wrench set</p>	 <p>Torque screwdriver Phillips head: M3</p>	 <p>Diagonal pliers</p>

Type	Tool			
	 Wire stripper	 Removal wrench Model: H4TW0001; manufacturer: Amphenol	 Rubber mallet	 Utility knife
	 Cable cutter	 Crimping tool Model: H4TC0003; manufacturer: Amphenol	 Multimeter DC voltage measurement range ≥ 1100 V DC	 Vacuum cleaner
	 Marker	 Measuring tape	 Bubble or digital level	 OT terminal crimping tool
	 Heat shrink tubing	 Heat gun	 Cable tie	N/A
PPE	 Safety gloves	 Safety goggles	 Anti-dust respirator	 Safety shoes

4.3 Determining the Installation Position

4.3.1 Environment Requirements

Basic Requirements

- The SUN2000 is protected to IP65 and can be installed indoors or outdoors.
- Do not install the SUN2000 in a place where personnel are easy to come into contact with its enclosure and heat sinks, because these parts are extremely hot during operation.
- Do not install the SUN2000 in areas with flammable or explosive materials.
- Do not install the SUN2000 at a place within children's reach.
- Do not install the SUN2000 outdoors in salt areas because it will be corroded there and may cause fire. A salt area refers to the region within 500 meters from the coast or prone to sea breeze. The regions prone to sea breeze vary depending on weather conditions (such as typhoons and monsoons) or terrains (such as dams and hills).
- The SUN2000 must be installed in a well-ventilated environment to ensure good heat dissipation.
- Recommended: Install the SUN2000 in a sheltered place or a place with an awning.

Mounting Structure Requirements

- The mounting structure where the SUN2000 is installed must be fireproof.
- Do not install the SUN2000 on flammable building materials.
- The SUN2000 is heavy. Ensure that the installation surface is solid enough to bear the weight load.
- In residential areas, do not install the SUN2000 on drywalls or walls made of similar materials which have a weak sound insulation performance because the noise generated by the SUN2000 is noticeable.

4.3.2 Space Requirements

Installation Angle Requirements

The SUN2000 can be wall-mounted or pole-mounted. The installation angle requirements are as follows:

- Install the SUN2000 vertically or at a maximum back tilt of 15 degrees to facilitate heat dissipation.
- Do not install the SUN2000 at forward tilted, excessive back tilted, side tilted, horizontal, or upside down positions.

Figure 4-1 Installation tilts

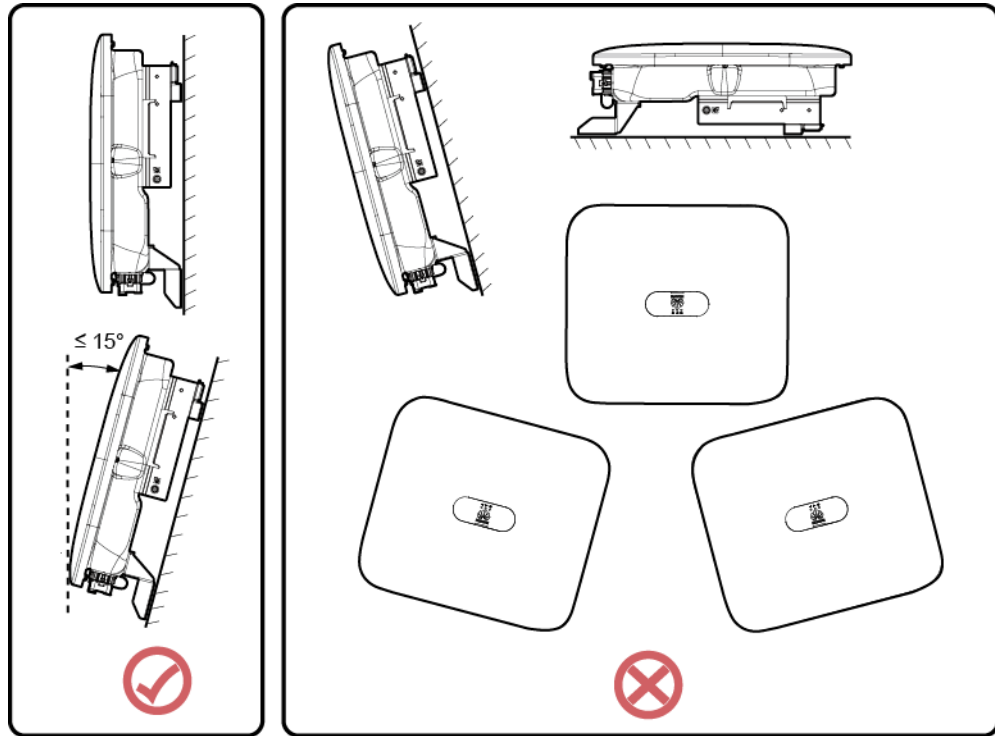

IS10H00012

Installation Space Requirements

- Reserve enough space around the SUN2000 to ensure sufficient space for installation and heat dissipation.

Figure 4-2 Installation space

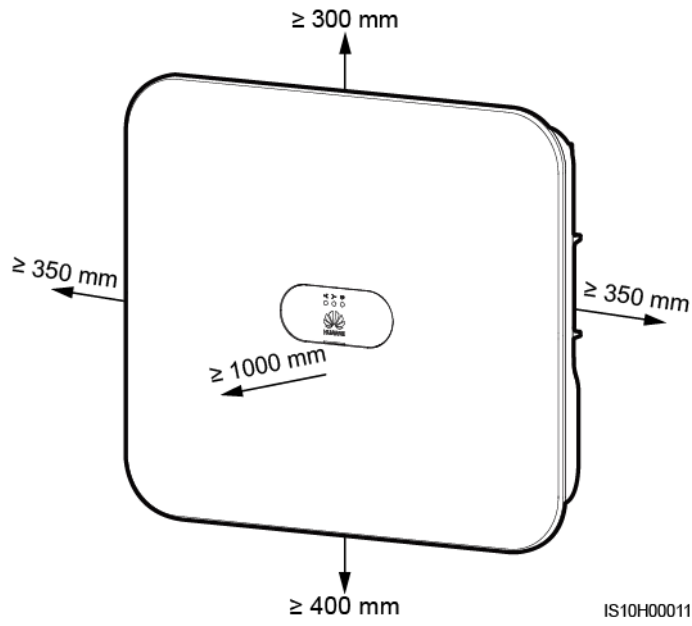

- When installing multiple SUN2000s, install them in horizontal mode if sufficient space is available and install them in triangle mode if no sufficient space is available. Stacked installation is not recommended.

Figure 4-3 Horizontal installation (recommended)

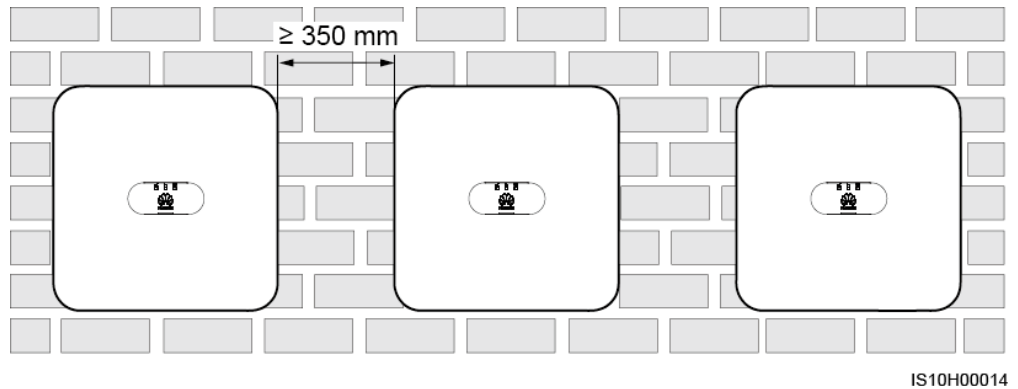
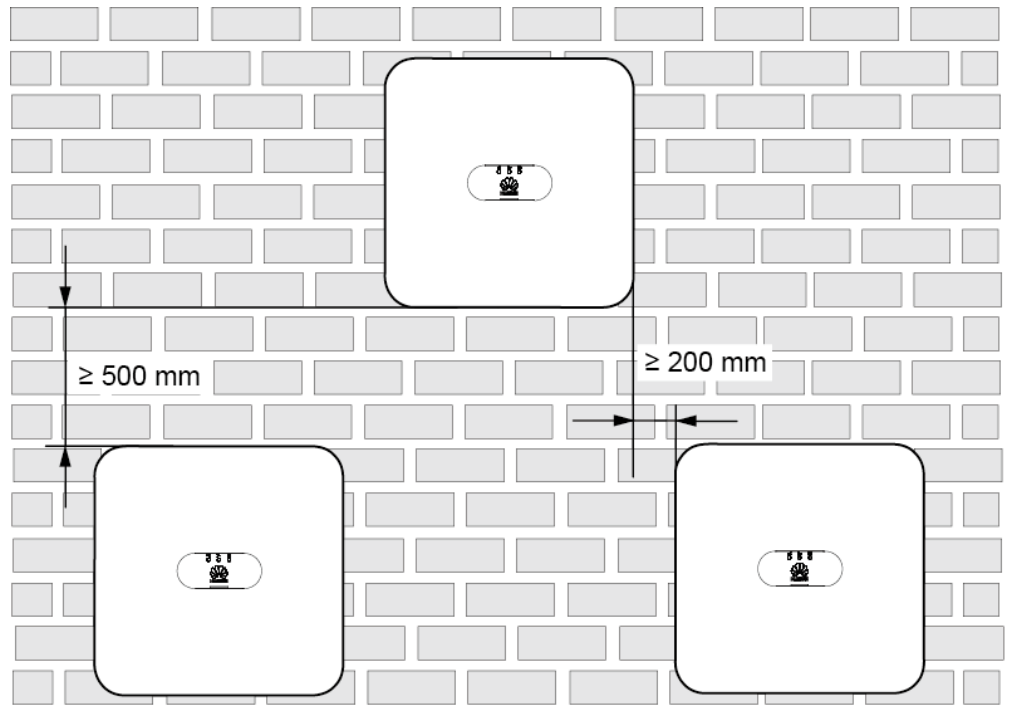
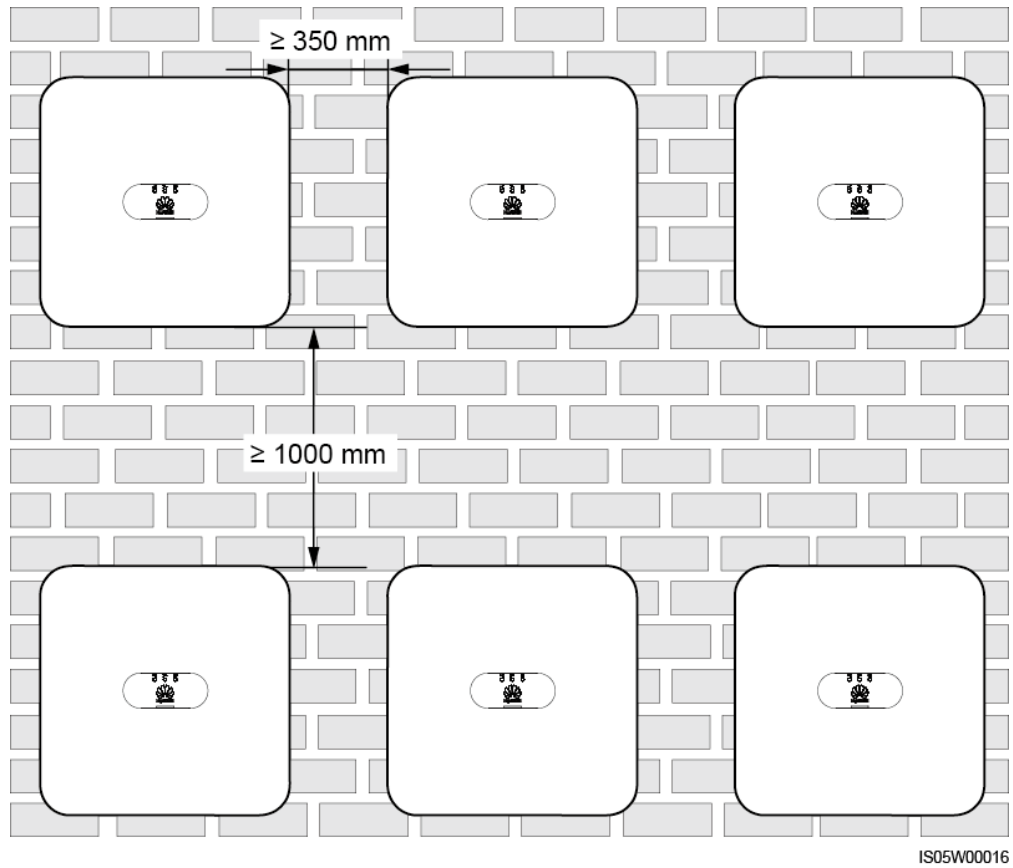

Figure 4-4 Staggered installation (recommended)



IS05W00017

Figure 4-5 Stacked installation (not recommended)



4.4 Moving an Inverter

Procedure

- Step 1** Two persons are required to move the inverter and one person on both sides. Lift the inverter from the packing case and move it to the specified installation position.

⚠ CAUTION

- To prevent personal injury and damage to the device, take care to keep your balance when moving the SUN2000.
- Do not use the wiring terminals and ports at the bottom to support any weight of the SUN2000.
- When you need to temporarily place the SUN2000 on the ground, use foam, paper or other protective materials to prevent damage to its enclosure.

Figure 4-6 Moving an inverter

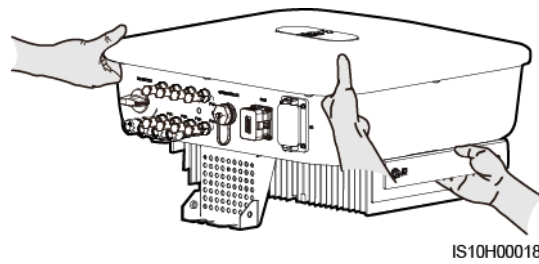

----End

4.5 Installing the Mounting Bracket

Installation Precautions

Figure 4-7 shows the dimensions of installation holes on the SUN2000.

Figure 4-7 Mounting bracket dimensions

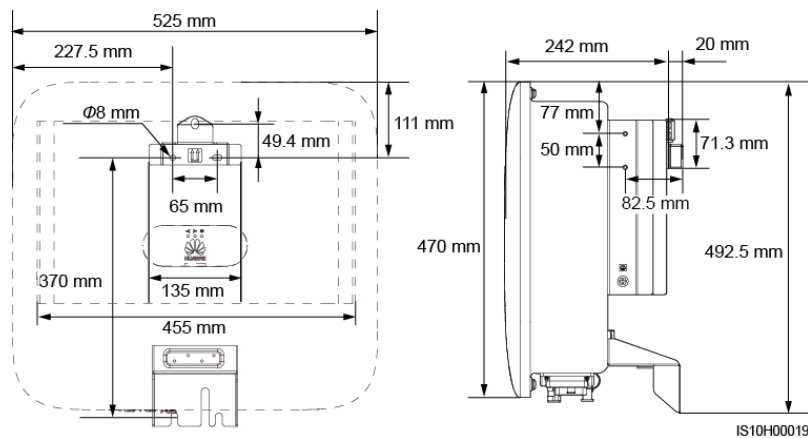

📖 NOTE

Two M6 screw holes are reserved on both left and right sides of the enclosure for installing an awning.

4.5.1 Wall-mounted Installation

Procedure

Step 1 Determine the installation positions for drilling holes, and mark the positions using a marker.

Step 2 Secure the mounting brackets.

NOTE

- M6x60 expansion bolts are delivered with the SUN2000. If the length and amount of the bolts do not meet installation requirements, prepare M6 stainless steel expansion bolts by yourself.
- The expansion bolts delivered with the inverter are used for solid concrete walls. For other types of walls, prepare bolts by yourself and ensure that the wall meets the load bearing requirements of the inverter.

Figure 4-8 Expansion bolt composition

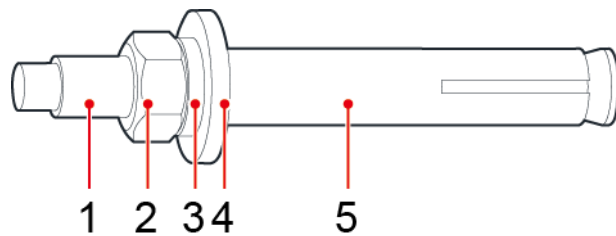

IS05W00018

- | | | |
|-----------------|--------------------|-------------------|
| (1) Bolt | (2) Nut | (3) Spring washer |
| (4) Flat washer | (5) Expansion tube | |

⚠ DANGER

Avoid drilling holes in the utility pipes or cables attached to the back of the wall.

NOTICE

- To prevent dust inhalation or contact with eyes, wear safety goggles and an anti-dust respirator when drilling holes.
- Clean up any dust in and around the holes using a vacuum cleaner and measure the distance between holes. If large hole tolerance exists, position and drill holes again.
- After removing the bolt, spring washer, and flat washer, level the front of the expansion tube with the concrete wall. Otherwise, the mounting brackets will not stay steady on the concrete wall.
- Partially loosen the nut, flat washer and spring washer of the two expansion bolts below.

Figure 4-9 Installing the Mounting Bracket

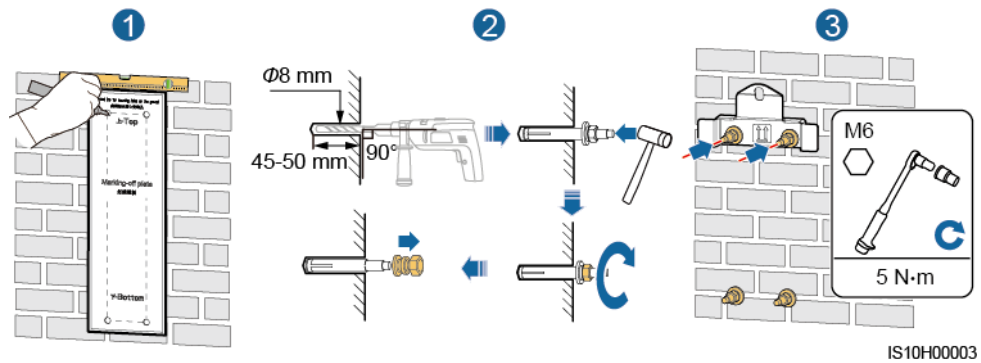

Step 3 Install the SUN2000 onto the mounting bracket.

Step 4 Tighten nuts.

Figure 4-10 Installing the SUN2000

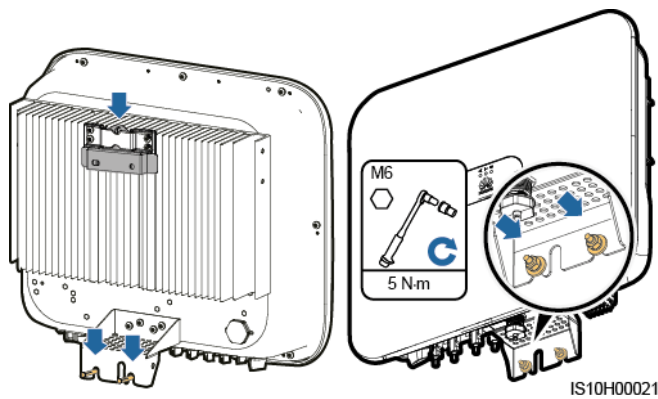

Step 5 (Optional) Install the anti-theft lock.

NOTICE

- Prepare an anti-theft lock suitable for the lock hole diameter ($\Phi 8$ mm) by yourself.
- An outdoor waterproof lock is recommended.
- Keep the key to the anti-theft lock safe.

Figure 4-11 Installing the anti-theft lock

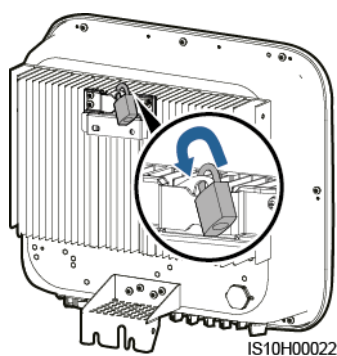

----End

4.5.2 Support-mounted Installation

Prerequisites

Prepare M6 stainless bolt assemblies (including flat washers, spring washers, and M6 bolts) with appropriate lengths as well as matched flat washers and nuts based on the support specifications.

Procedure

- Step 1** Determine the hole positions based on the marking-off template, and then mark the hole positions using a marker.

Figure 4-12 Determining hole positions

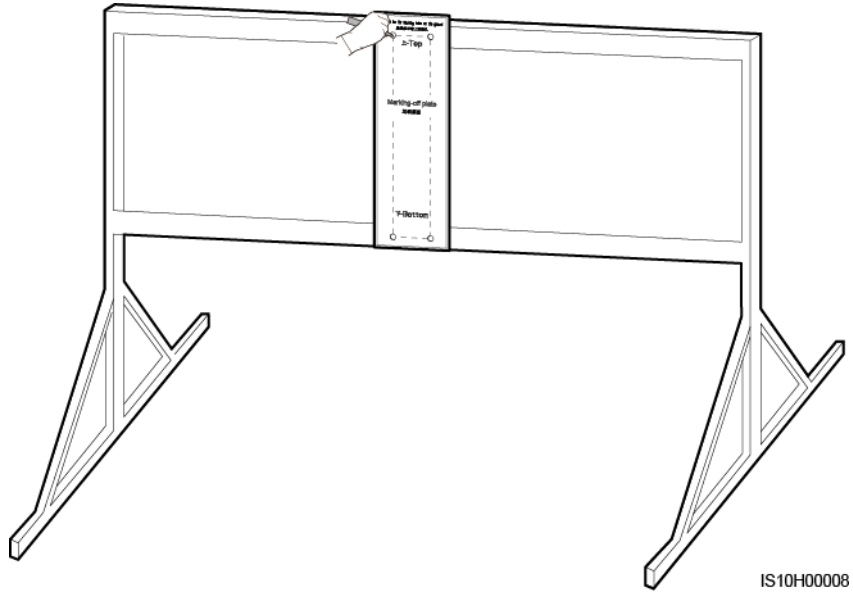

Step 2 Drill holes using a hammer drill.

NOTE

You are advised to apply anti-rust paint on the hole positions for protection.

Figure 4-13 Drilling holes

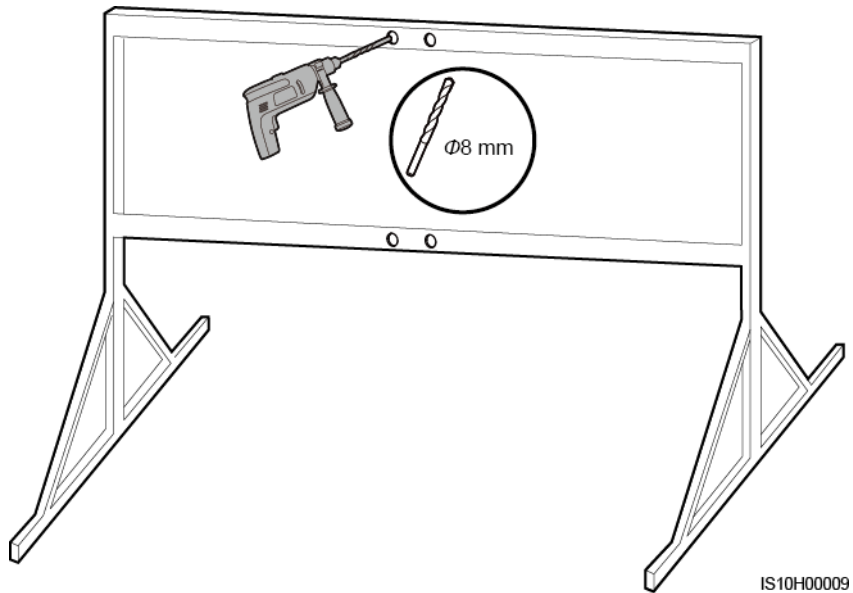

Step 3 Secure the mounting bracket.

Figure 4-14 Securing the mounting bracket

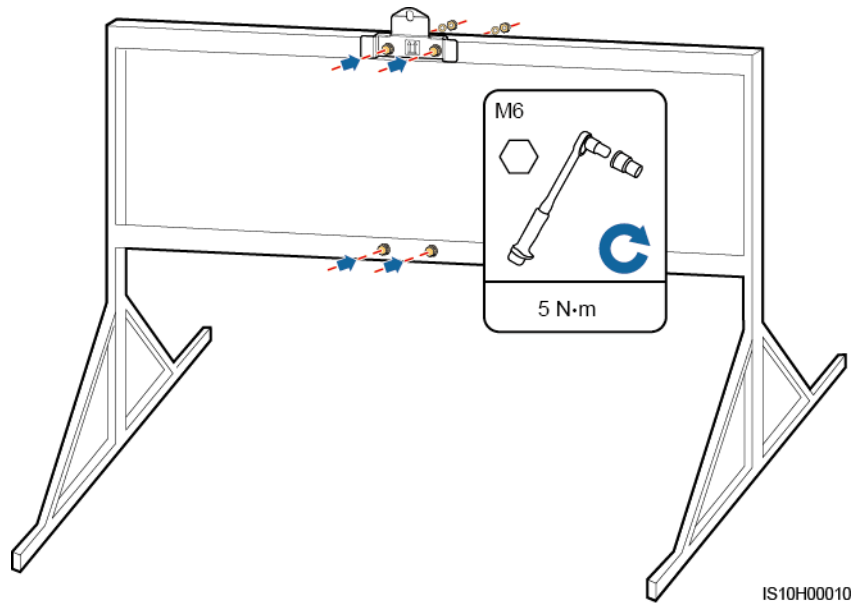

Step 4 Install the SUN2000 onto the mounting bracket.

Step 5 Tighten the bolt assembly.

Figure 4-15 Installing the SUN2000

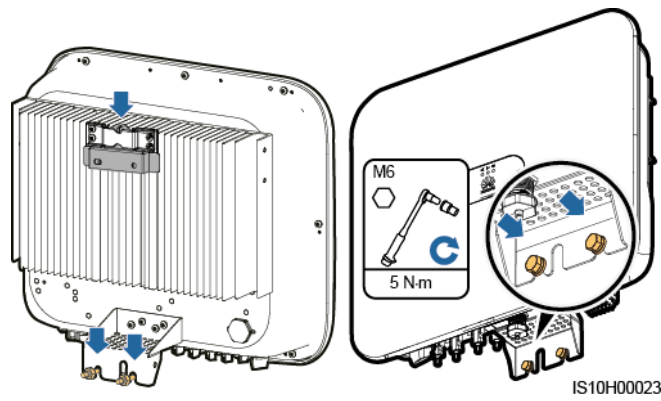

Step 6 (Optional) Install the anti-theft lock.

NOTICE

- Prepare an anti-theft lock suitable for the lock hole diameter ($\Phi 8$ mm) by yourself.
- An outdoor waterproof lock is recommended.
- Keep the key to the anti-theft lock safe.

Figure 4-16 Installing the anti-theft lock

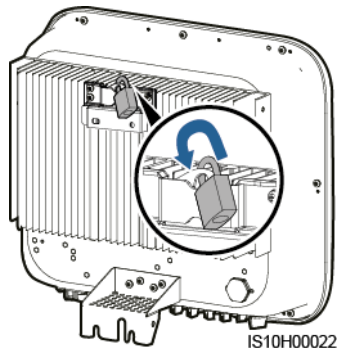

----End

5 Electrical Connections

5.1 Preparing for Installation

Figure 5-1 SUN2000 cable connections (optional in dashed boxes)

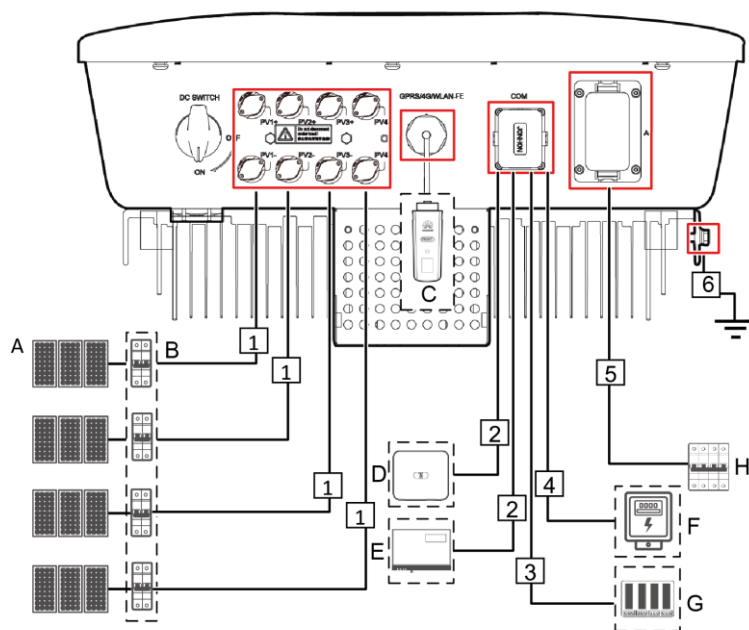

NOTICE

If the Smart Dongle is configured, you are advised to install the Smart Dongle before connecting the signal cable.

Table 5-1 Component description

No.	Component	Description	Source
A	PV module	<ul style="list-style-type: none"> A PV string is composed of the PV modules connected in series. The SUN2000 supports the input from four PV strings. 	Prepared by the customer
B	DC switch	Recommended: a PV circuit breaker with a rated voltage greater than or equal to 1,100 V DC and a rated current of 15 A.	Prepared by the customer
C	Smart Dongle ^a	<ul style="list-style-type: none"> WLAN-FE Smart Dongle: SDongleA-05. 4G Smart Dongle: SDongleA-03. 	Purchased from Huawei
D	SUN2000	Select a proper model based on requirements.	Purchased from Huawei
E	SmartLogger1000A	Select a proper model based on requirements.	Purchased from Huawei
F	Smart Power Sensor	The recommended electricity meter model is DTSU666-H.	Purchased from Huawei
G	Ripple Control Device	Select the devices that meet the power grid scheduling requirements.	Provided by local power grid companies
H	AC switch ^b	Recommended: a three-phase AC circuit breaker with a rated voltage greater than or equal to 415 V AC and a rated current of: <ul style="list-style-type: none"> 25 A (SUN2000-8KTL-M0, SUN2000-10KTL-M0, SUN2000-12KTL-M0) 40 A (SUN2000-15KTL-M0, SUN2000-17KTL-M0, SUN2000-20KTL-M0) 	Prepared by the customer
<ul style="list-style-type: none"> Note a: WLAN-FE Smart Dongle: For details about the SDongleA-05 operation, see <i>SDongleA-05 Quick Guide (WLAN-FE)</i>; 4G Smart Dongle: For details about the SDongleA-03 operation, see <i>SDongleA-03 Quick Guide (4G)</i>. You can obtain the quick guide at https://support.huawei.com/enterprise by searching for the Smart Dongle model. Note b: The SUN2000-8KTL-M0 and SUN2000-10KTL-M0 inverters are applicable only to Australia. 			

Table 5-2 Cable description

No.	Name	Type	Recommended Specifications
1	DC input power cable	Standard PV cable in the industry	<ul style="list-style-type: none"> Conductor cross-sectional area: 4–6 mm² Cable outer diameter: 4.5–7.8 mm
2	(Optional) RS485 communications cable (used to cascade inverters or connect to the RS485 signal port on the SmartLogger)	Two-core outdoor shielded twisted pair cable	<ul style="list-style-type: none"> Conductor cross-sectional area: 0.2–1 mm² Cable outer diameter: 4–11 mm
3	(Optional) RS485 communications cable (used to connect to the RS485 signal port on a Smart Power Sensor for export limitation)	Two-core outdoor shielded twisted pair cable	<ul style="list-style-type: none"> Conductor cross-sectional area: 0.2–1 mm² Cable outer diameter: 4–11 mm
4	(Optional) Grid scheduling signal cable	Five-core outdoor cable	<ul style="list-style-type: none"> Conductor cross-sectional area: 0.2–1 mm² Cable outer diameter: 4–11 mm
5	AC output power cable ^a	Outdoor copper cable ^b	SUN2000-8KTL-M0, SUN2000-10KTL-M0, SUN2000-12KTL-M0: <ul style="list-style-type: none"> Conductor cross-sectional area: 6–16 mm² Cable outer diameter: 11–26 mm
			SUN2000-15KTL-M0, SUN2000-17KTL-M0, SUN2000-20KTL-M0: <ul style="list-style-type: none"> Conductor cross-sectional area: 10–16 mm² Cable outer diameter: 11–26 mm
6	PE cable	Single-core outdoor copper cable ^c	SUN2000-8KTL-M0, SUN2000-10KTL-M0, SUN2000-12KTL-M0: Conductor cross-sectional area ≥ 6 mm ²

No.	Name	Type	Recommended Specifications
			SUN2000-15KTL-M0, SUN2000-17KTL-M0, SUN2000-20KTL-M0: Conductor cross-sectional area $\geq 10 \text{ mm}^2$
<ul style="list-style-type: none"> Note a: The minimum cable diameter depends on the fuse rating on the AC side. Note b: The SUN2000-8KTL-M0 and SUN2000-10KTL-M0 inverters are applicable only to Australia. Note c: The SUN2000-8KTL-M0 and SUN2000-10KTL-M0 inverters are applicable only to Australia. 			

 **NOTE**

- The minimum cable diameter should comply with the local cable standard.
- Factors influencing cable selection are as follows: nominal AC current, type of cable, routing method, ambient temperature, and maximum desired line losses.

5.2 Connecting the PE cable

Precautions

 **DANGER**

- Ensure that the PE cable is properly connected. If it is disconnected or loose, electric shocks may occur.
- Do not connect the neutral wire to the enclosure as a PE cable. Otherwise, electric shocks may occur.

 **NOTE**

- The PE point at the AC output port is used only as a PE equipotential point, and cannot substitute for the PE point on the enclosure.
- After the ground cable is installed, it is recommended that the silica gel or paint be applied to the ground terminal for protection.

Additional Information

The SUN2000 has the grounding detection function. This function detects whether the SUN2000 is grounded properly before its startup, or whether the ground cable is disconnected when the SUN2000 is running. This function works under limited conditions. To ensure the safe operation of the SUN2000, ground the SUN2000 properly according to the connection requirements of the PGND cable. For some power grid types, if the output side of the inverter is connected to an isolation transformer, ensure that the inverter is properly grounded and set **isolation settings** to **Input not grounded, with a transformer** to enable the inverter to run properly.

- According to IEC62109, to ensure safe application in case of the ground cable is damaged or disconnected, connect the PE cable properly before the grounding detection function is disabled. Ensure that the PE cable meets at least one of the following requirements.
 - The PE cable is a single-core outdoor copper cable with a conductor cross-sectional area of at least 10 mm².
 - Use cables that have the same diameter as the AC output cable, and ground the PE terminal on the AC connector and the ground screw on the enclosure respectively.
- In some countries and regions, additional ground cables are required for the SUN2000. In this case, use cables that have the same diameter as the AC output cable, and ground the PE terminal on the AC connector and the ground screw on the enclosure respectively.

Procedure

Step 1 Crimp the OT terminal.

NOTICE

- Pay attention not to damage the core wire when stripping a cable.
- The cavity formed after crimping the conductor strip of the OT terminal needs to wrap the core wire completely. The core wire needs to contact the OT terminal closely.
- Wrap the wire crimping area with the heat shrink tubing or the PVC insulation tape. The following figure uses the heat shrink tubing as an example.
- When using the heat gun, protect devices from being scorched.

Figure 5-2 Crimping an OT terminal

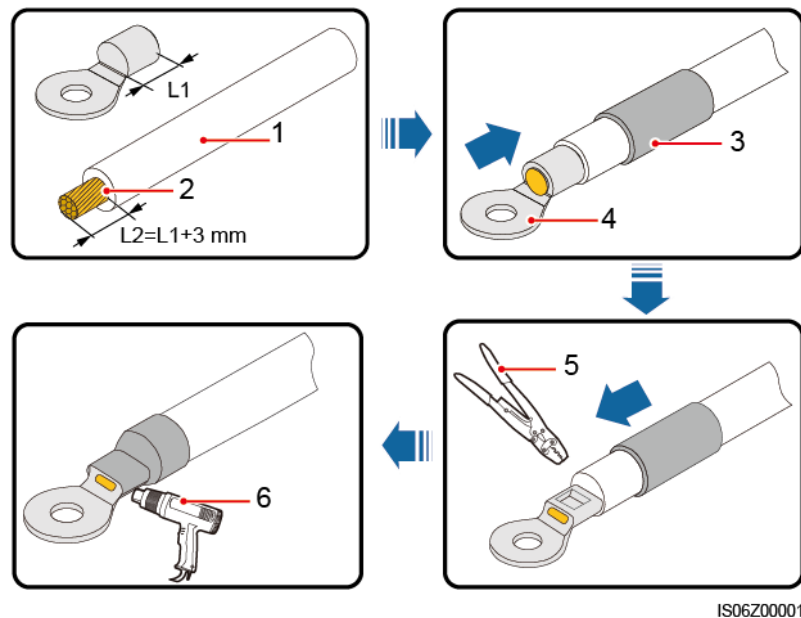

(1) Cable

(2) Core wire

(3) Heat shrink tubing

(4) OT terminal

(5) Crimping tool

(6) Heat gun

Step 2 Connect the PE cable.

Figure 5-3 Connecting the PE cable

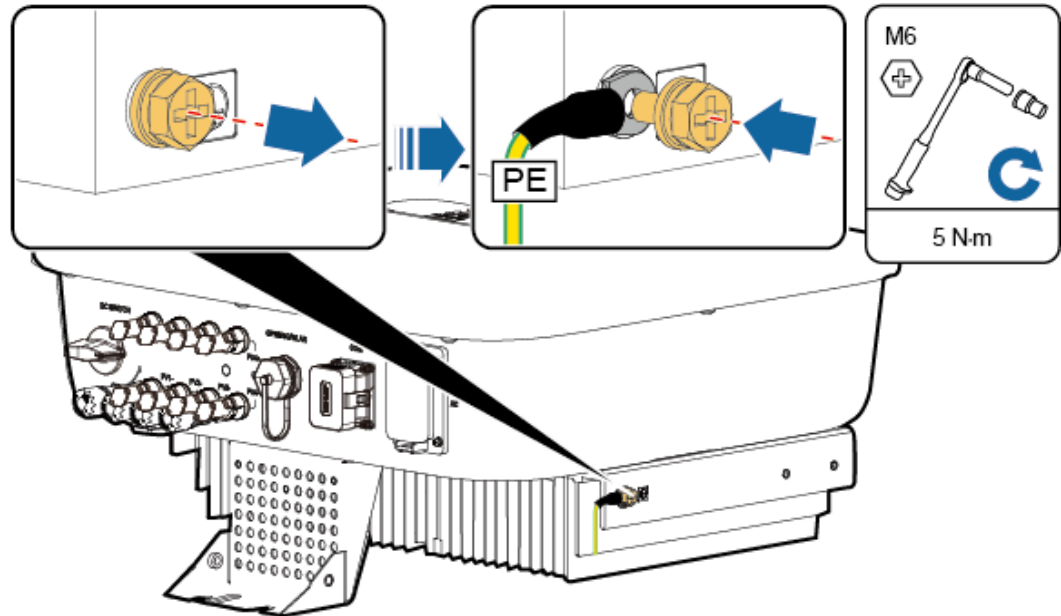

IS10110001

----End

5.3 Connecting the AC Output Power Cable

Precautions

A three-phase AC switch needs to be installed on the AC side of the SUN2000. To ensure that the SUN2000 can safely disconnect itself from the power grid when an exception occurs, select a proper overcurrent protection device in compliance with local power distribution regulations.

⚠ WARNING

Do not connect loads between the SUN2000 and the AC switch directly connected to it.

The SUN2000 is integrated with a comprehensive residual current monitoring unit. Once detecting that the residual current exceeds the threshold, the SUN2000 immediately disconnects itself from the power grid.

NOTICE

- If the external AC switch can perform earth leakage protection, the rated leakage action current should be greater than or equal to 100 mA.
- If multiple SUN2000s connect to the general residual current device (RCD) through their respective external AC switches, the rated leakage action current of the general RCD should be greater than or equal to the number of SUN2000s multiplied by 100 mA.
- A knife switch cannot be used as an AC switch.
- The hex key is delivered with the inverter and bound to the hanging kit at the bottom of the inverter.

Figure 5-4 Hex key

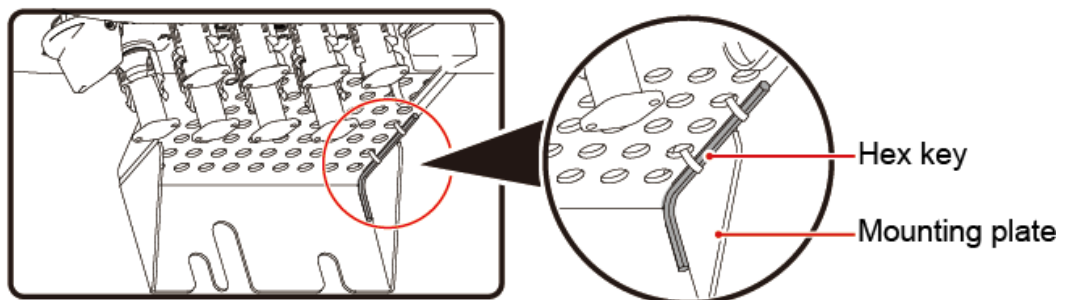

IS10H00024

Procedure

- Step 1** Connect the AC output power cable to the AC connector.

Figure 5-5 Stripping requirements

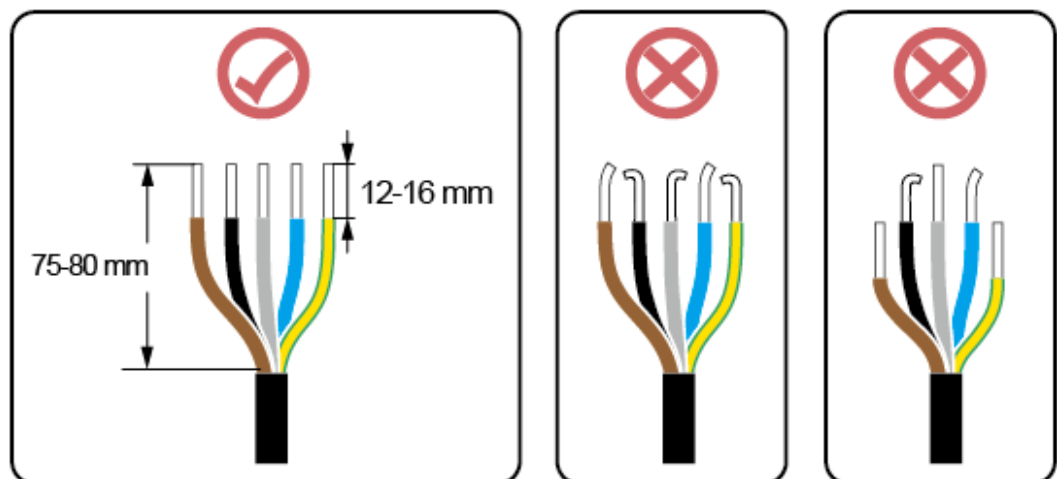

IS06I20048

NOTICE

- Ensure that the cable jacket is inside the connector.
- Ensure that the exposed core wire is totally inserted into the cable hole.
- Ensure that AC terminations provide firm and solid electrical connections. Failing to do so may cause SUN2000 malfunction and damage to its AC connectors.
- Ensure that the cable is not twisted.

Figure 5-6 Three-core cable (L1, L2, and L3)

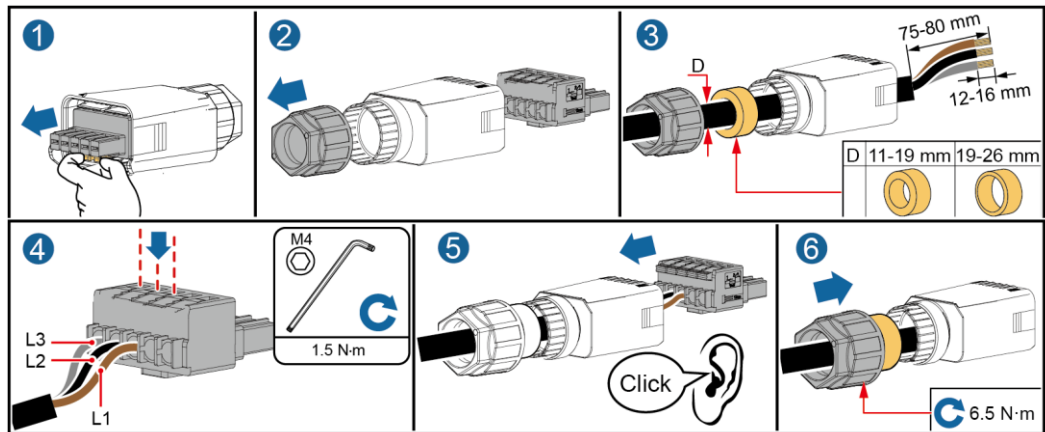

IS10I20016

Figure 5-7 Four-core cable (L1, L2, L3, and PE)

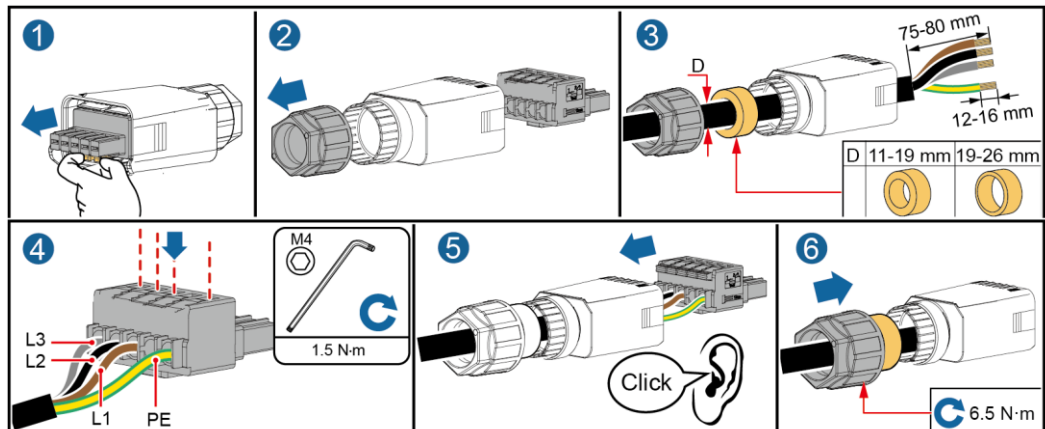

IS10I20015

Figure 5-8 Four-core cable (L1, L2, L3, and N)

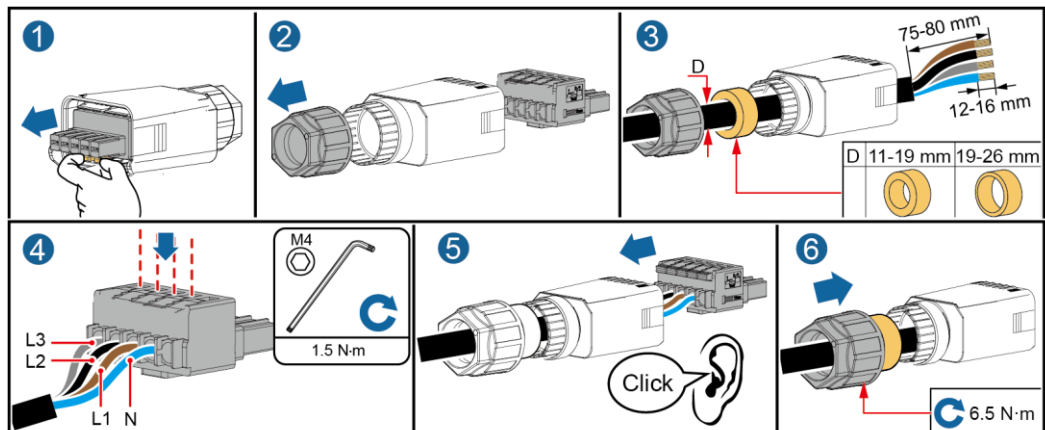

IS10120014

Figure 5-9 Five-core cable (L1, L2, L3, N, and PE)

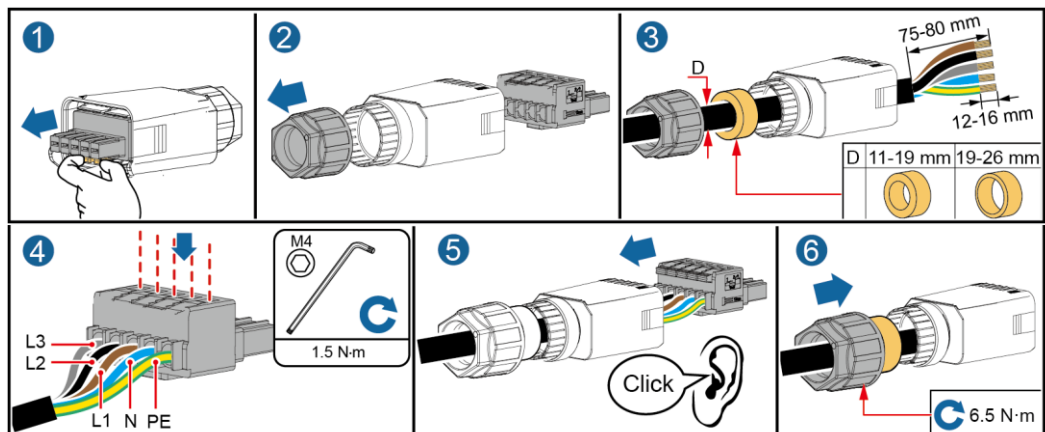

IS10120013

NOTE

The cable colors shown in the figures are for reference only. Select an appropriate cable according to local standards.

Step 2 Connect the AC connector to the AC output port.

NOTICE

Ensure that the AC connector is connected securely.

Figure 5-10 Securing the AC connector

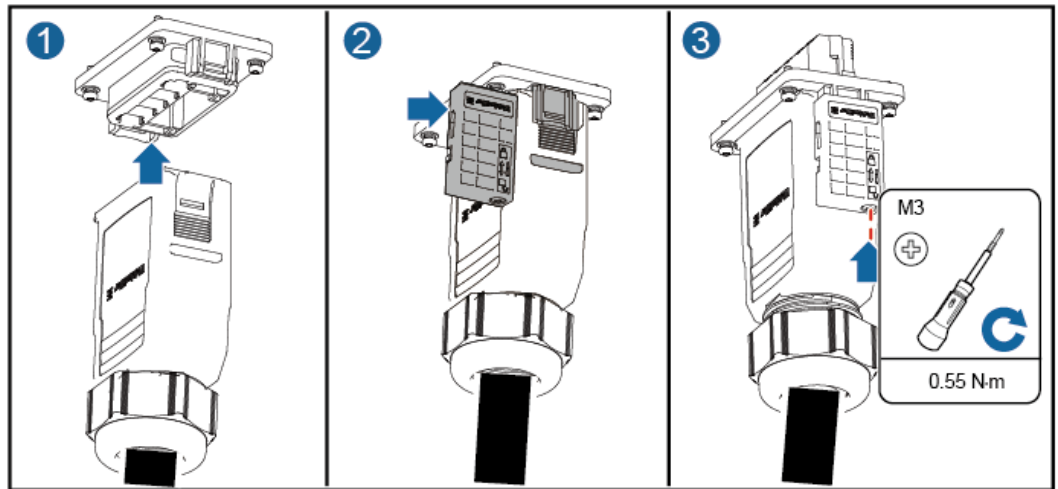

IS10H20001

Step 3 Check the route of the AC output power cable.

Figure 5-11 Cable route

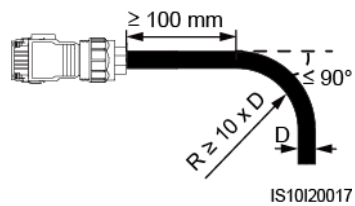

----End

Disconnection

Disconnection can be performed in reverse order.

5.4 Connecting the DC input power cable

Precautions

 **DANGER**

- Before connecting the DC input power cable, ensure that the DC voltage is within the safe range (lower than 60 V DC), and that the **DC SWITCH** is set to the **OFF** position. Failure to do so could generate high voltage, which may cause electric shocks.
 - When the SUN2000 is operating, it is not allowed to operate the DC input power cable, such as connecting or disconnecting a PV string or a PV module in a PV string. Failing to do so may cause electric shocks.
 - If no PV string is connected to a DC input terminal of the SUN2000, do not remove the watertight cap from the terminal. Otherwise, the IP rating of the SUN2000 will be affected.
-

 **WARNING**

Ensure that the following conditions are met. Otherwise, the SUN2000 may be damaged, or even a fire could happen.

- PV modules connected in series in each PV string are of the same specifications.
 - The open-circuit voltage of each PV string is always lower than or equal to 1080 V DC.
 - The maximum short-circuit current of each PV string must be lower than or equal to 15 A.
 - The DC input power cable is correctly connected. The positive and negative terminals of a PV module are connected to corresponding positive and negative DC input terminals of the SUN2000.
 - If the DC input power cable is reversely connected, do not operate the DC switch and positive and negative connectors. Wait until the solar irradiance declines at night and the PV string current reduces to below 0.5 A, and then turn off the DC switch. Remove the positive and negative connectors to correct the polarity.
-

NOTICE

- Because the output of the PV string connected to the SUN2000 cannot be grounded, ensure that the PV module output is insulated to ground.
- The PV strings connecting to the same MPPT circuit should contain PV modules of the same model and quantity.
- During the installation of PV strings and the SUN2000, the positive or negative terminals of PV strings may be short-circuited to ground if power cables are not properly installed or routed. An AC or DC short circuit may occur and damage the device when the SUN2000 is operating. The caused device damage is not covered under any warranty.

Terminal Description

Figure 5-12 Terminals

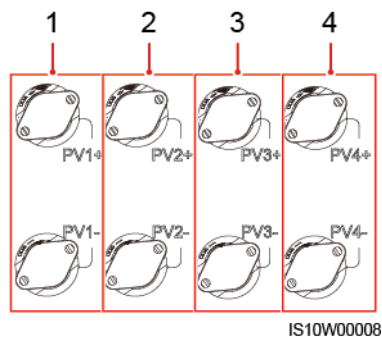

(1) Terminals of DC input 1

(2) Terminals of DC input 2

(3) Terminals of DC input 3

(4) Terminals of DC input 4

NOTE

It is recommended that the number of PV modules connected to PV1 and PV2 be the same, and that the number of PV modules connected to PV3 and PV4 be the same.

Procedure

Step 1 Connect the DC input power cable.

WARNING

Before inserting the positive and negative connectors into the positive and negative DC input terminals of the SUN2000, check that the **DC SWITCH** is **OFF**.

CAUTION

Use the Amphenol Helios H4 PV connectors supplied with the SUN2000. If the PV connectors are lost or damaged, purchase the connectors of the same model. The device damage caused by incompatible PV connectors is not covered under any warranty.

NOTICE

- Cables with high rigidity, such as armored cables, are not recommended as DC input power cables, because poor contact may be caused by the bending of the cables.
- Before assembling DC connectors, label the cable polarities correctly to ensure correct cable connections.
- After crimping the positive and negative metal contacts, pull the DC input power cables back to ensure that they are connected securely.
- Insert the crimped metal contacts of the positive and negative power cables into the appropriate positive and negative connectors. Then pull back the DC input power cables to ensure that they are connected securely.
- Crimp the metal stamping forming contacts using crimping tool H4TC0003 (Amphenol, recommended), H4TC0002 (Amphenol), PV-CZM-22100 (Staubli), or PV-CZM-19100 (Staubli). When choosing PV-CZM-22100 or PV-CZM-19100, do not use the locator. Otherwise metal contacts would be damaged.

Figure 5-13 Crimping tool (H4TC0003)

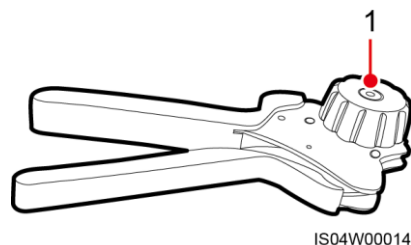

(1) Locator

NOTE

- The DC voltage measurement range of the multimeter must be at least 1100 V.
- If the voltage is a negative value, the DC input polarity is incorrect and needs correction.
- If the voltage is greater than 1080 V, too many PV modules configured in the same string. Remove some PV modules.

Figure 5-14 Connecting the DC input power cable

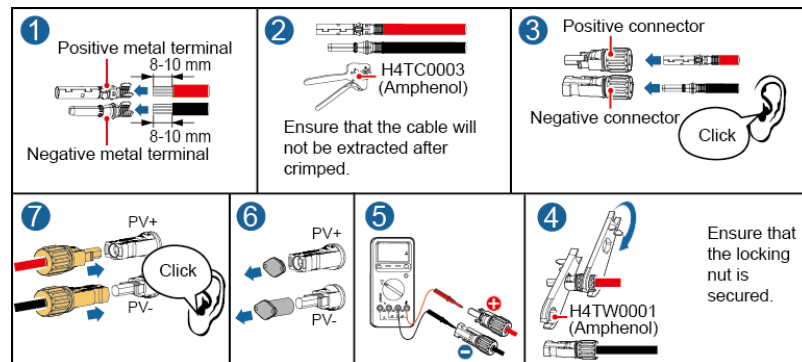

IS10130003

NOTICE

If the DC input power cable is reversely connected and the **DC SWITCH** is set to the **ON** position, do not operate the **DC SWITCH** and positive and negative connectors. Otherwise, the device may be damaged. The caused device damage is not covered under any warranty. Wait until the solar irradiance declines and the PV string current drops to below 0.5 A. Then set the two **DC SWITCH** to the **OFF** position, remove the positive and negative connectors, and rectify the connection of the DC input power cable.

----End

Removing a DC connector

WARNING

Before removing the positive and negative connectors, ensure that the **DC SWITCH** is **OFF**.

To remove the positive and negative connectors from the SUN2000, insert an open-end wrench into the notch and press hard to remove the DC connector.

Figure 5-15 Removing a DC connector

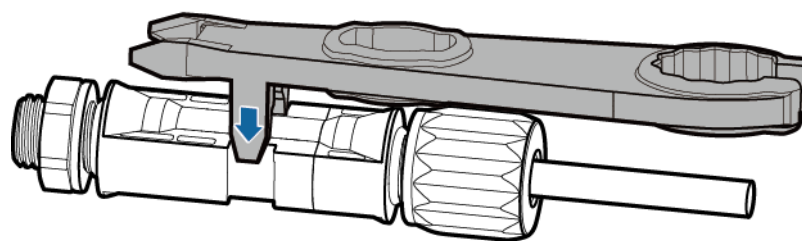

IS011C0042

5.5 (Optional) Installing the Smart Dongle

Procedure

NOTE

- If you prepared a WLAN-FE Smart Dongle or 4G Smart Dongle configured with a SIM card, skip this step.
- If you prepared a Smart Dongle without a SIM card, you need to prepare a standard SIM card (size: 25 mm x 15 mm) with the capacity greater than or equal to 64 KB.
- When installing the SIM card, determine its installation direction based on the silk screen and arrow on the card slot.
- When being pressed into place, the SIM card will be locked, which means that the card is installed correctly.
- To remove the SIM card, push it inwards. Then the SIM card springs out automatically.
- When reinstalling the WLAN-FE Smart Dongle or 4G Smart Dongle, ensure that the buckle springs back in place.
- 4G Smart Dongle

Figure 5-16 Installing the 4G Smart Dongle

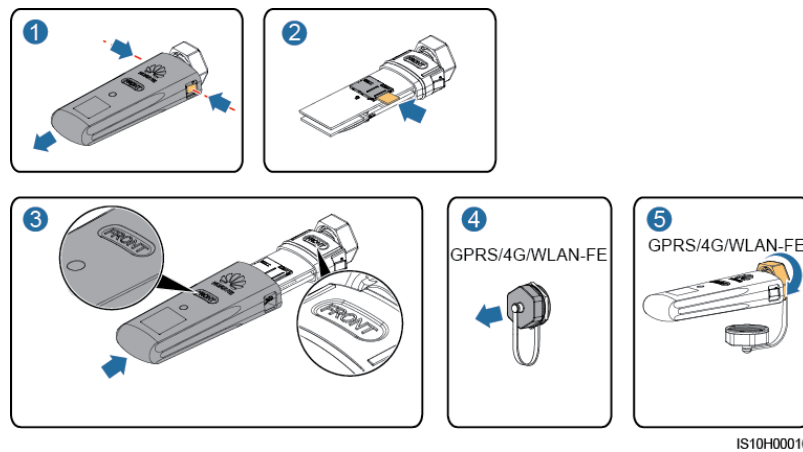

- WLAN-FE Smart Dongle (WLAN Communication)

Figure 5-17 Installing the WLAN-FE Smart Dongle (WLAN Communication)

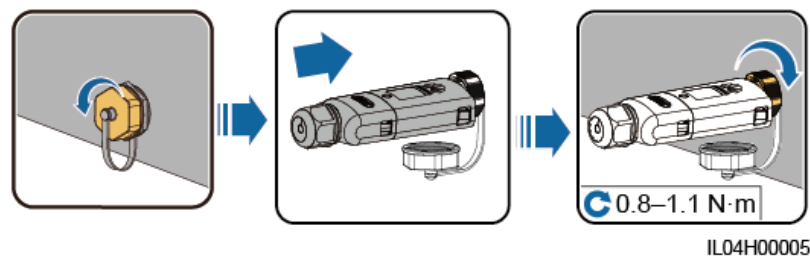

- WLAN-FE Smart Dongle (FE Communication)

Figure 5-18 Installing the WLAN-FE Smart Dongle (FE Communication)

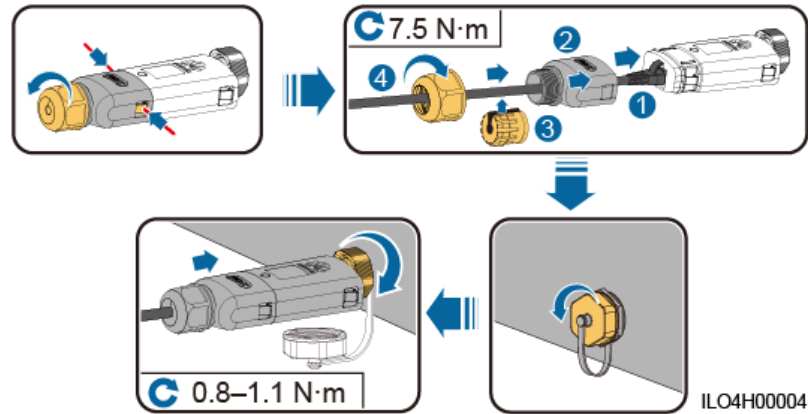

NOTE

There are two types of Smart Dongle involved in this document:

- WLAN-FE Smart Dongle: SDongleA-05
- 4G Smart Dongle: SDongleA-03

For details, see the quick guide that is delivered with the Smart Dongle.

5.6 (Optional) Installing the Signal Cable

Communication port signal definitions

NOTICE

- When routing the signal cable, ensure that it is separate from the power cable and away from interfering sources to prevent communication from being affected.
- The protection layer of the cable is in the connector. Cut off surplus core wires from the protection layer. Ensure that the core wires are completely inserted into the cable holes, and that the cable is securely connected.

Figure 5-19 Signal definitions

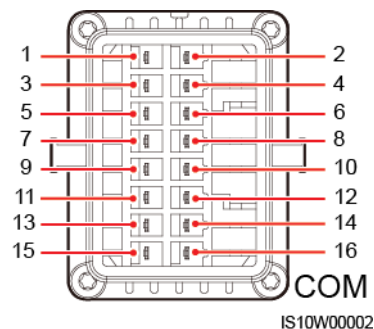

Table 5-3 Signal definitions

Pin	Definiton	Function	Description	Pin	Definiton	Function	Description
1	485A1-1	RS485 differential signal+	Used to connect to the RS485 signal port on the SUN2000 or SmartLogger1000A	2	485A1-2	RS485 differential signal+	Used to connect to the RS485 signal port on the SUN2000 or SmartLogger1000A
3	485B1-1	RS485 differential signal-		4	485B1-2	RS485 differential signal-	
5	PE	Shielding ground	N/A	6	PE	Shielding ground	N/A
7	485A2	RS485 differential signal+	Used to connect to an RS485 signal port on a Smart Power Sensor for export limitation	8	DIN1	Dry contact interface for grid scheduling	Connects to the Ripple Control Device.
9	485B2	RS485 differential signal-		10	DIN2		
11	N/A	N/A		N/A	12		
13	GND	Signal ground	N/A	14	DIN4		
15	N/A	N/A	N/A	16	GND		

Communication Networking

- Smart Dongle Networking Scenario

Figure 5-20 Smart Dongle networking

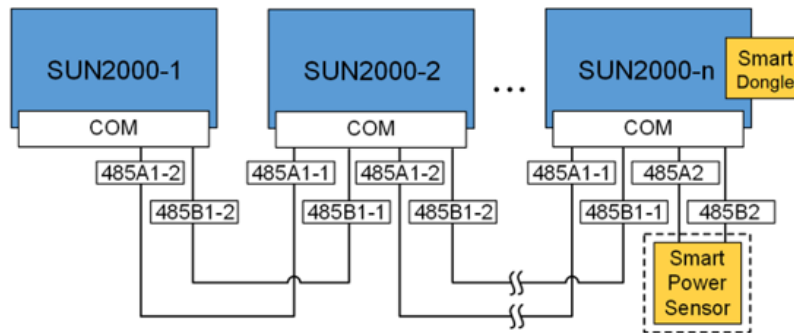

NOTE

- In the Smart Dongle networking scenario, the SmartLogger1000A cannot be connected.
- The Smart Power Sensor is necessary for export limitation. Only the DTSU666-H Smart Power Sensor (provided by Huawei) can be used.
- The Smart Power Sensor and Smart Dongle need to be connected to the same inverter.
- SmartLogger1000A Networking Scenario

Figure 5-21 SmartLogger1000A networking

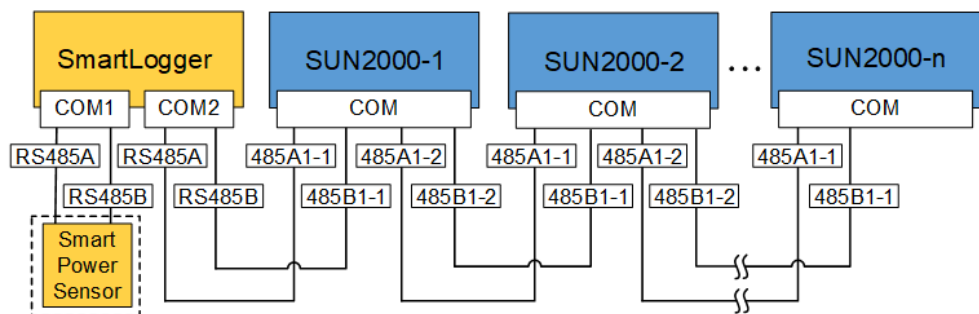

NOTE

- In the SmartLogger1000A networking scenario, the Smart Dongle cannot be connected.
- A maximum of 80 devices can connect to a single SmartLogger1000A, such as inverters, Smart Power sensor, and EMI. You are advised to connect fewer than 30 devices to each RS485 route.
- The Smart Power Sensor is necessary for export limitation. Select the Smart Power Sensor according to the actual project.
- To ensure the system response speed, the Smart Power Sensor is recommended to be connected to a COM port separately from inverter COM port.

5.6.1 Connecting the RS485 Communications Cable (Inverter Cascading)

Procedure

- Step 1** Connect the signal cable to the signal cable connector.

Figure 5-22 Installing the cable

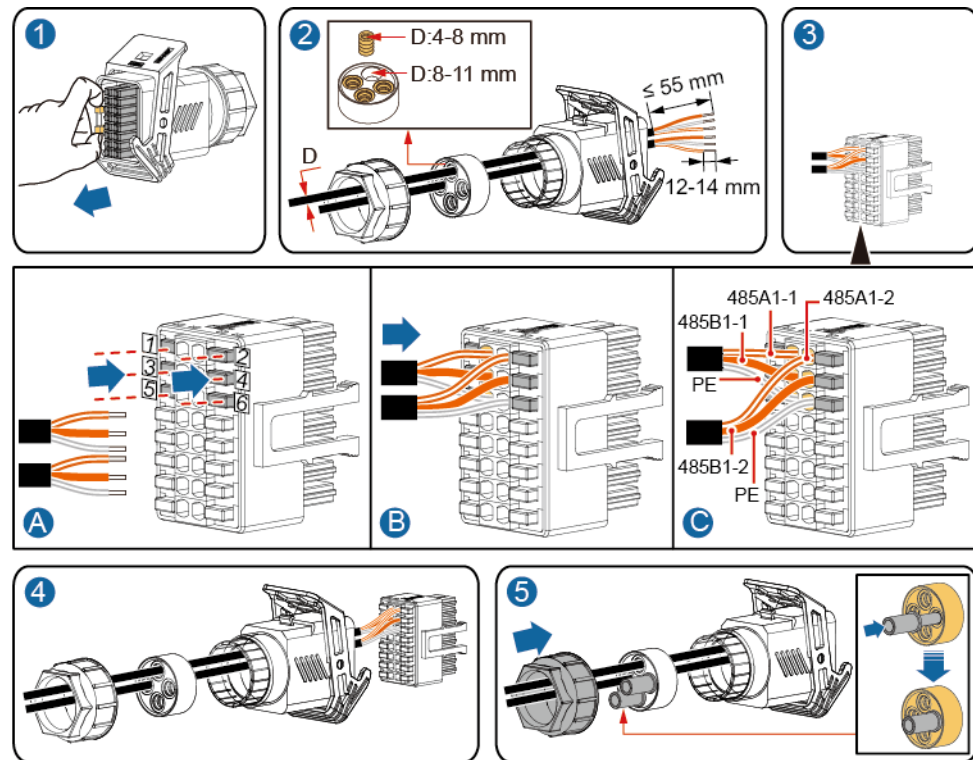

IS10120006

Step 2 Connect the signal cable connector to the COM port.

Figure 5-23 Securing the signal cable connector

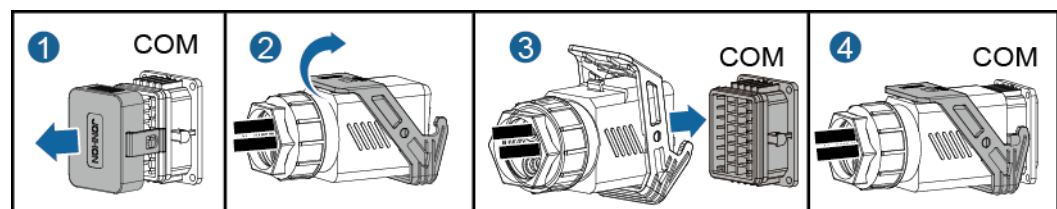

IS10120007

----End

5.6.2 Connecting the RS485 Communications Cable (Smart Power Sensor)

Cable Connection

The following figure shows the cable connections between the inverter and the Smart Power Sensor.

Figure 5-24 Cable connection (Three Phase Three Wire)

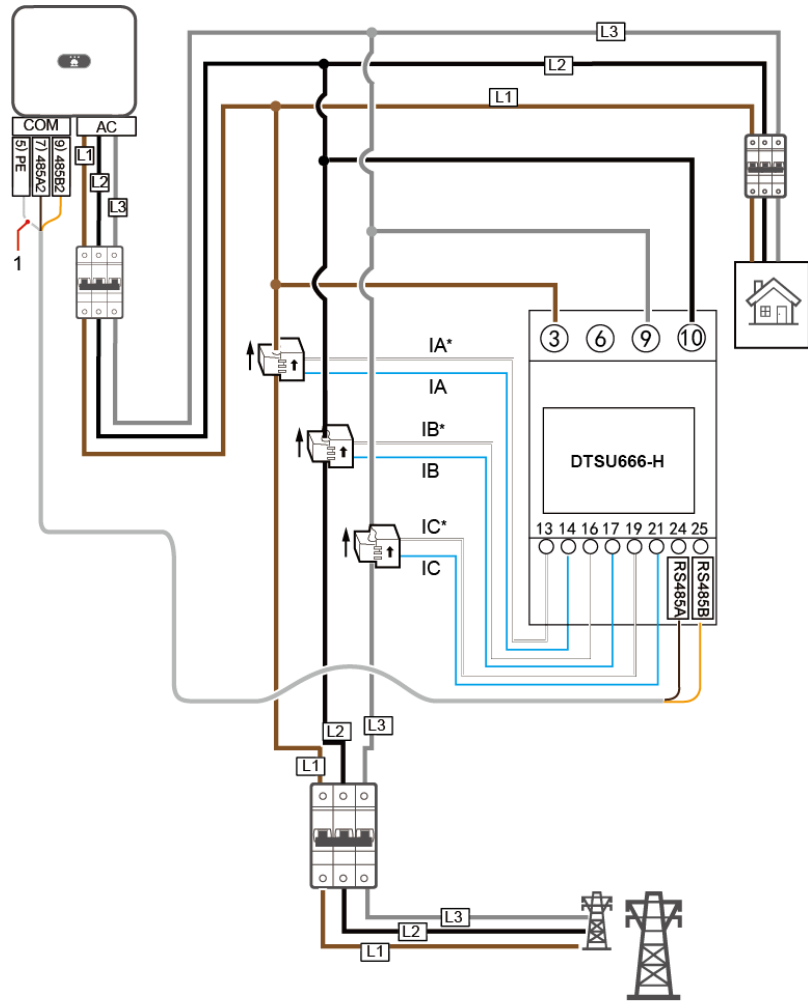

IH05N00005

Figure 5-25 Cable connection (Three Phase Four Wire)

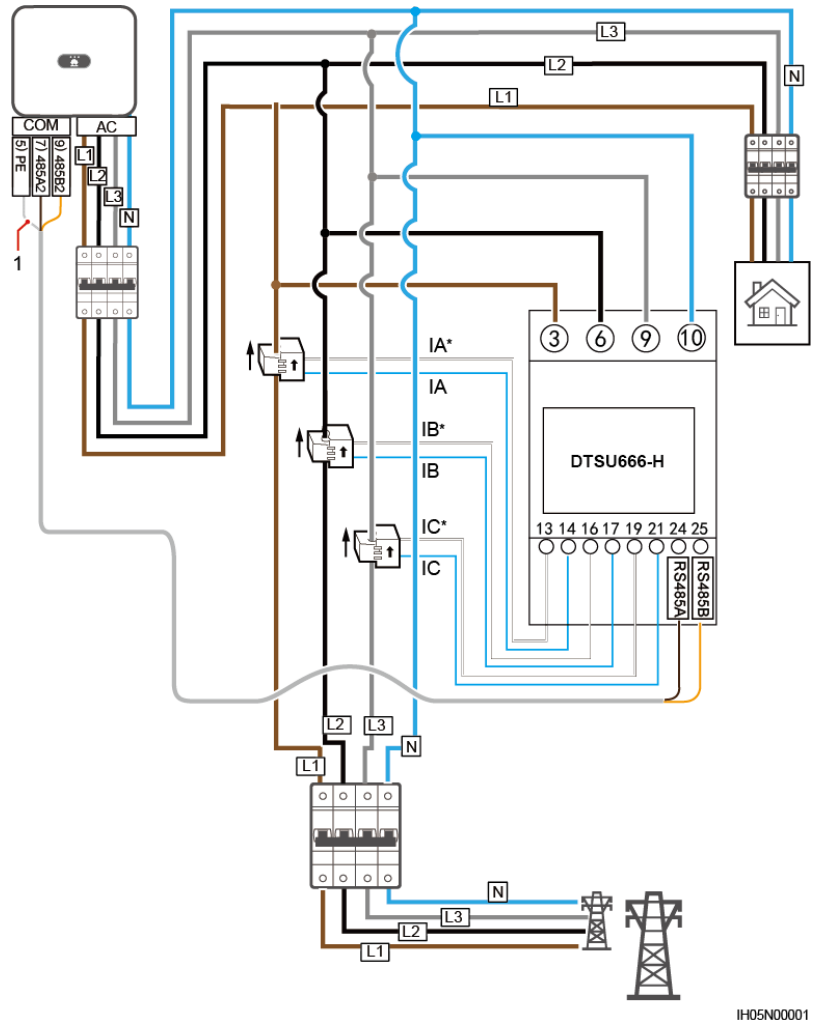

(1) Shielding layer of the signal cable

Procedure

Step 1 Connect the signal cable to the signal cable connector.

Figure 5-26 Installing the cable

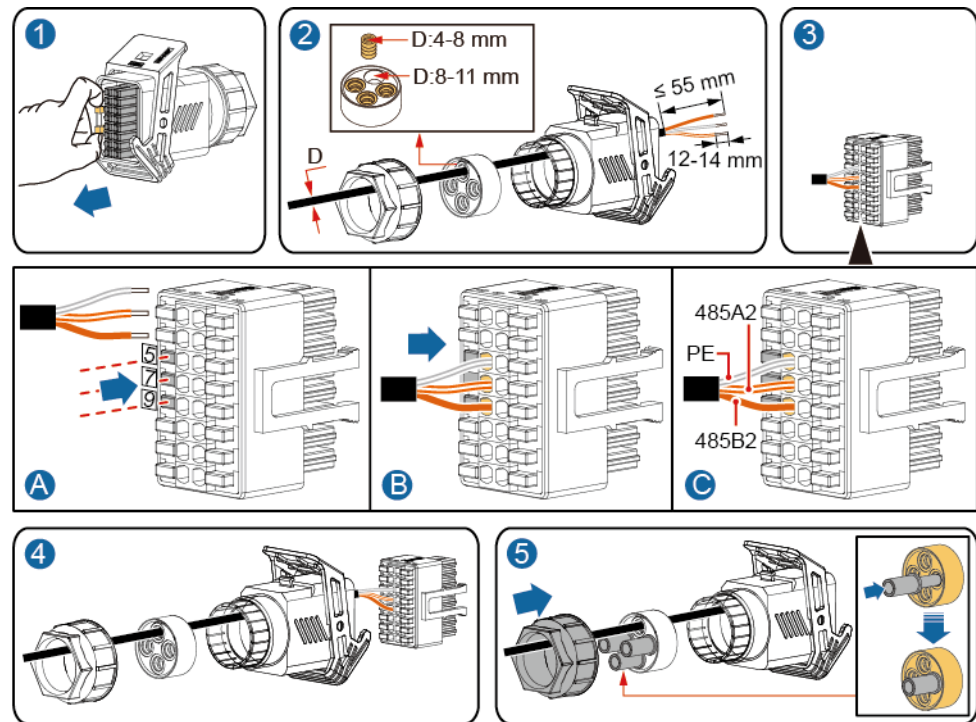

IS10I20008

Step 2 Connect the signal cable to the COM port.

Figure 5-27 Securing the signal cable connector

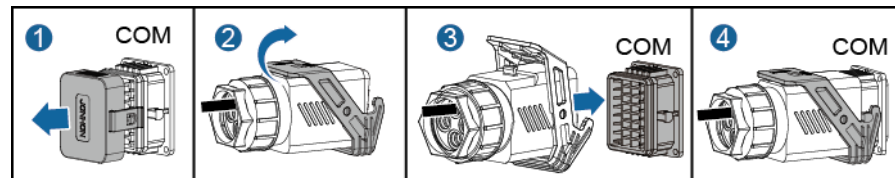

IS10I20007

----End

5.6.3 Connecting the Power Grid Scheduling Signal Cable

Cable Connection

The following figure shows the cable connections between the inverter and the Ripple Control Device.

Figure 5-28 Cable connection

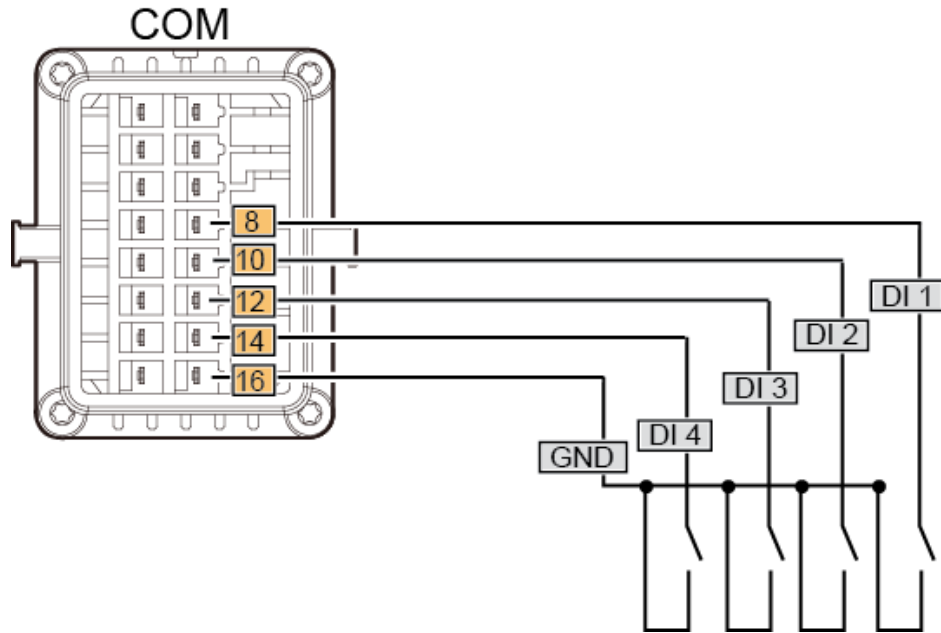

Procedure

Step 1 Connect the signal cable to the signal cable connector.

Figure 5-29 Installing the cable

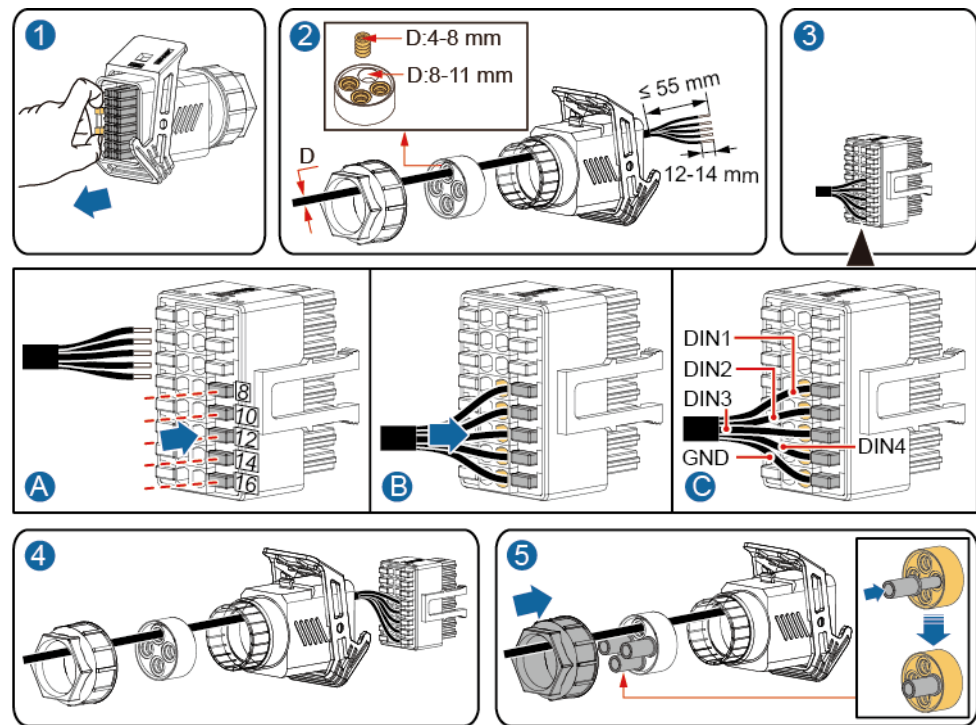

IS10I20010

Step 2 Connect the signal cable to the COM port.

Figure 5-30 Securing the signal cable connector

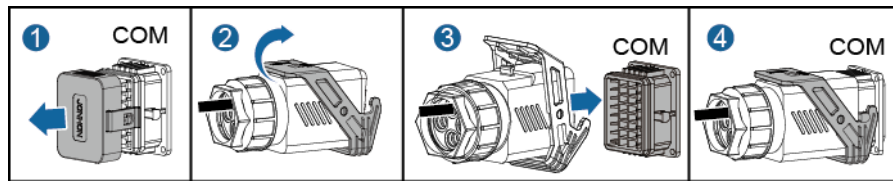

IS10I20007

----End

6 Commissioning

6.1 Check Before Power-On

Table 6-1 Installation checklist

No.	Check Item	Acceptance Criteria
1	SUN2000 installation	The SUN2000 is installed correctly, securely, and reliably.
2	Smart Dongle	The Smart Dongle is installed correctly and securely.
3	Cable layout	Cables are routed properly as required by the customer.
4	Cable tie	Cable ties are secured evenly and no burr exists.
5	Grounding	The ground cable is connected correctly, securely, and reliably.
6	Turn off the switches	The DC SWITCH and all the switches connected to the SUN2000 are set to OFF .
7	Cable connections	The AC output power cable and DC input power cable are connected correctly, securely, and reliably.
8	Unused terminals and ports	Unused terminals and ports are locked by watertight caps.
9	Installation environment	The installation space is proper, and the installation environment is clean and tidy, without foreign matter.

6.2 Powering On the System

Precautions

NOTICE

Before turning on the AC switch between the SUN2000 and the power grid, use a multimeter set to the AC position to check that the AC voltage is within the specified range.

Procedure

Step 1 Turn on the AC switch between the SUN2000 and the power grid.

NOTICE

If the DC is on and the AC is off, the SUN2000 reports a **Grid Failure** alarm. The SUN2000 starts normally only after the fault is automatically rectified.

Step 2 If there is a DC switch between the PV string and the inverter, turn on the DC switch.

Step 3 Set the **DC SWITCH** at the bottom of the SUN2000 to the **ON** position.

Step 4 Wait for about 1 minute, and then observe the LED indicators of the inverter to check the running status.

Table 6-2 LED indicator description

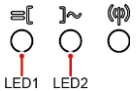
Category	Status		Meaning
Running indication 	LED1	LED2	N/A
	Steady green	Steady green	The SUN2000 is operating in grid-tied mode.
	Blinking green at long intervals (on for 1s and then off for 1s)	Off	The DC is on and the AC is off.
	Blinking green at long intervals (on for 1s and then off for 1s)	Blinking green at long intervals (on for 1s and then off for 1s)	The DC is on, the AC is on, and the SUN2000 is not exporting power to the power grid.
	Off	Off	The DC is off. ^a
	Blinking red at short intervals (on for 0.2s and then off for 0.2s)	N/A	DC environmental alarm

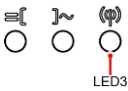
Category	Status		Meaning
	N/A	Blinking red at short intervals (on for 0.2s and then off for 0.2s)	AC environmental alarm
	Steady red	Steady red	Fault
Communication indication 	LED3		N/A
	Blinking green at short intervals (on for 0.2s and then off for 0.2s)		Communication is in progress. (When a mobile phone is connected to the SUN2000, the indicator first indicates that the phone is connected to the SUN2000); blinks green at long intervals.)
	Blinking green at long intervals (on for 1s and then off for 1s)		The mobile phone is connected to the SUN2000.
	Off		There is no communication.
Note a: The AC may be on. Check whether the external AC switch is OFF.			

Step 5 (Optional) Observe the LED to check the operating status of the Smart Dongle.

- WLAN-FE Smart Dongle

Figure 6-1 WLAN-FE Smart Dongle

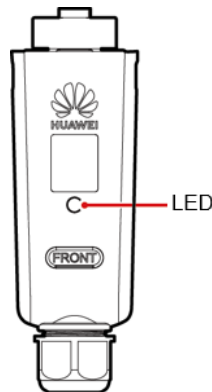

Table 6-3 LED indicator description

LED Color	Status	Remarks	Description
N/A	Off	Normal	The Dongle is not secured or is not powered on.
Yellow (blinking green and red simultaneously)	Steady on		The Dongle is secured and powered on.

LED Color	Status	Remarks	Description
Red	Blinking at short intervals (on for 0.2s and then off for 0.2s)		The parameters for connecting to the router are to be set.
	Steady on	Abnormal	The Dongle is faulty. Replace the Dongle.
Green	Blinking at long intervals (on for 0.5s and then off for 0.5s)	Normal	Connecting to the router.
	Steady on		Successfully connected to the management system.
	Blinking at short intervals (on for 0.2s and then off for 0.2s)		The inverter is communicating with the management system through the Dongle.

- 4G Smart Dongle

Table 6-4 LED indicator description

LED Color	Status	Remarks	Description
N/A	Off	Normal	The Dongle is not secured or is not powered on.
Yellow (blinking green and red simultaneously)	Steady on	Normal	The Dongle is secured and powered on.
Green	Blinking in a 2-second cycle (on for 0.1s and then off for 1.9s)	Normal	Dialing (duration < 1 min).
		Abnormal	If the duration is longer than 1 min, the 4G parameter settings are incorrect. Reset the parameters.
	Blinking at long intervals (on for 1s and then off for 1s)	Normal	The dial-up connection is set up successfully (duration < 30s).
		Abnormal	If the duration is longer than 30s, the settings of the management system parameters are incorrect. Reset the parameters.
Steady on	Normal	Successfully connected to the management system.	

LED Color	Status	Remarks	Description
	Blinking at short intervals (on for 0.2s and then off for 0.2s)		The inverter is communicating with the management system through the Dongle.
Red	Steady on	Abnormal	The Dongle is faulty. Replace Dongle.
	Blinking at short intervals (on for 0.2s and then off for 0.2s)		The Dongle has no SIM card or the SIM card is in poor contact. Check whether the SIM card has been installed or is in good contact. If not, install the SIM card or remove and insert the SIM card.
	Blinking at long intervals (on for 1s and then off for 1s)		The Dongle fails to connect to the management system because it has no signals, weak signal, or no traffic. If the Dongle is reliably connected, check the SIM card signal through the APP. If no signal is received or the signal strength is weak, contact the carrier. Check whether the tariff and traffic of the SIM card are normal. If not, recharge the SIM card or buy traffic.
Blinking red and green alternatively	Blinking at long intervals (on for 1s and then off for 1s)		No communication with the inverter. <ul style="list-style-type: none"> • Remove and insert the Dongle. • Check whether inverters match the Dongle. • Connect the Dongle to other inverters. Check whether the Dongle or the USB port of the inverter is faulty.

----End

6.3 Commissioning

6.3.1 Scenario 1: Smart Dongle Networking Scenario

NOTE

Data in the screenshots is for reference only. The actual screens prevail.

Downloading the App

Search for "FusionSolar" in Google Play or scan the corresponding QR code, download the installation package, and install the FusionSolar app by following the instructions.

Figure 6-2 FusionSolar QR code



NOTE

- You can also download and install the FusionSolar app from App Store. The iOS version will not be updated after 2.3.3 temporarily. The latest Android version is required for local commissioning. The iOS version is only for viewing the PV plant information.



- In Britain, only the FusionHome app can be used for commissioning. This document uses the FusionSolar app as an example to describe the commissioning method. For the FusionHome app, perform operations as required.
- Search for **FusionHome** in Google Play or scan the corresponding QR code, download the installation package, and install the FusionHome app by following the instructions. You can also download and install the FusionHome app from App Store. The iOS version will not be updated after 3.1.00.003 temporarily. The latest Android version is required for local commissioning. The iOS version is only for viewing the PV plant information.



- The initial password for connecting the inverter WiFi is **Changeme**
- Log in to the FusionHome app as **installer**. The initial password is **00000a**.
- Use the initial password upon first power-on and change it immediately after login. To ensure account security, change the password periodically and keep the new password in mind. Not changing the initial password may cause password disclosure. A password left unchanged for a long period of time may be stolen or cracked. If a password is lost, devices cannot be accessed. In these cases, the user is liable for any loss caused to the PV plant.

(Optional) Installer Account Registration

Creating the first installer account will generate a domain named after the company.

NOTE

If you have an installer account, skip this step.

Figure 6-3 Creating the first installer account



NOTICE

To create multiple installer accounts for the same company, log in to the FusionSolar app and tap **New User**.

Figure 6-4 Creating multiple installer accounts for the same company

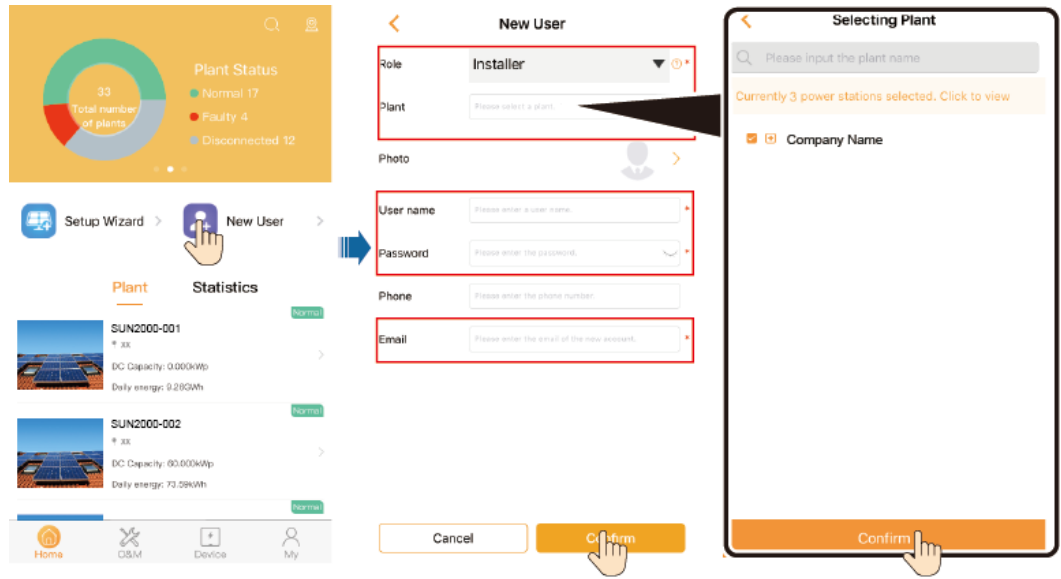

Creating a PV Plant and an Account for User

Figure 6-5 Creating a PV Plant and an Account for User

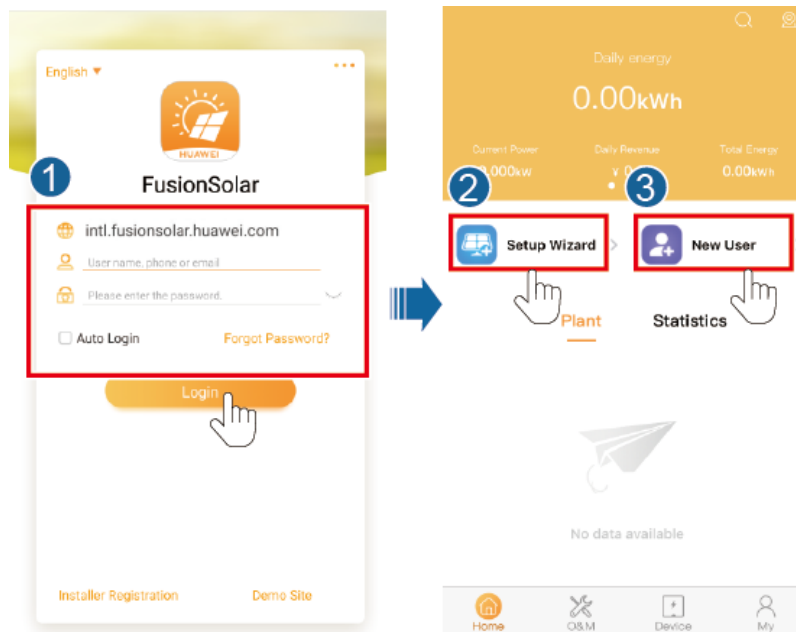

NOTE

For details, see the [FusionSolar App Quick Guide](#). You can scan the QR code to obtain it.



6.3.2 Scenario 2: SmartLogger1000A Networking Scenario

See the *Distributed PV Plants Connecting to Huawei Hosting Cloud Quick Guide (Distributed Inverters + SmartLogger1000A + RS485 Networking)*.

You can scan the QR code to obtain it.



6.3.3 Other Scenarios

1. Access **Inverter commissioning**.

Figure 6-6 Method 1: before login

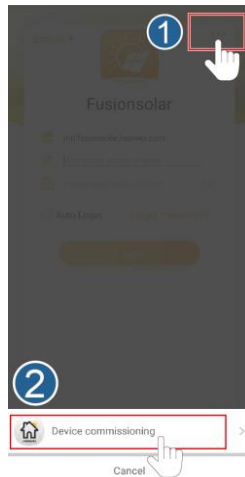
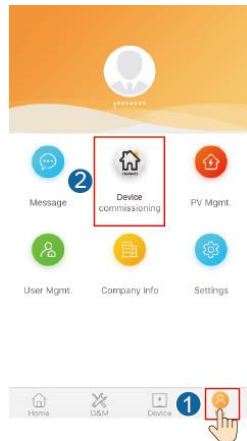

Figure 6-7 Method 2: after login



2. Connect to the inverter WiFi. Log in as **installer**, and perform **Quick settings**.

NOTE

- When the inverter is directly connected to the mobile phone using the built-in antenna, the distance between the inverter and mobile phone must be less than 5 m without obstructions in between to ensure the communication quality between the FusionSolar app and inverter. The distance is for reference only and may vary depending on mobile phones and whether there are obstructions between the inverter and the mobile phone.
- When connecting the SUN2000L to the FusionSolar app over a router, ensure that the mobile phone and inverter are in the WiFi coverage of the router and the SUN2000L is connected to the router.
- The router supports WiFi (IEEE 802.11 b/g/n, 2.4 GHz) and the WiFi signal reaches the inverter.
- The WPA, WPA2, or WPA/WPA2 encryption mode is recommended for routers. Enterprise-level encryption is not supported (for example, public hotspots requiring authentication such as airport WiFi). WEP and WPA TKIP are not recommended because these two encryption modes have serious security defects. If the inverter cannot be connected using WEP, log in to the router and change the encryption mode to WPA2 or WPA/WPA2. If the inverter cannot be connected using WEP, log in to the router and change the encryption mode to WPA2 or WPA/WPA2.

Figure 6-8 Quick settings

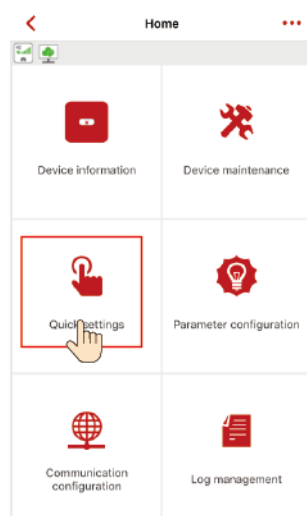

NOTE

- The initial password for connecting the inverter WiFi is **Changeme**
 - The initial password of the **installer** is **00000a**
 - Use the initial password upon first power-on and change it immediately after login. To ensure account security, change the password periodically and keep the new password in mind. Not changing the initial password may cause password disclosure. A password left unchanged for a long period of time may be stolen or cracked. If a password is lost, devices cannot be accessed. In these cases, the user is liable for any loss caused to the PV plant.
 - To set more parameters, tap **Parameter configuration**.
3. (Optional) When multiple inverters are connected to a third-party data collector, set RS485 parameters.

Figure 6-9 RS485 Settings

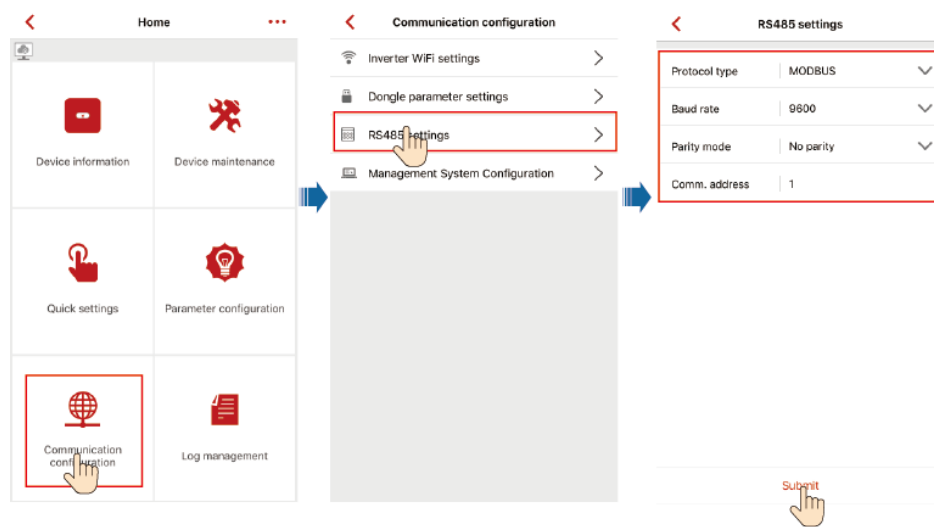

NOTE

The RS485 addresses of different inverters must be different.

6.4 Powering Off the System

Precautions

WARNING

After the SUN2000 is powered off, the remaining electricity and heat may still cause electric shocks or body burns. Therefore, put on protective gloves and operate the SUN2000 five minutes after the power-off.

Procedure

- Step 1** Send a shutdown command from the app.

Step 2 Turn off the AC switch between the SUN2000 and the power grid.

Step 3 Set the **DC SWITCH** at the bottom of the SUN2000 to the **OFF** position.

Step 4 Turn off the DC switch between the PV string and the SUN2000 if there is one.

----End

7 Maintenance

7.1 Routine Maintenance

To ensure that the SUN2000 can operate properly for a long term, you are advised to perform routine maintenance on it as described in this chapter.

 **CAUTION**

Before cleaning the system, connecting cables, and maintaining the grounding reliability, power off the system.

Table 7-1 Maintenance list

Check Detail	Check Method	Maintenance Interval
System cleanliness	Check the heat sink for foreign matter or the overall health of the SUN2000.	Annual or every time an abnormality is detected
System running status	Check the SUN2000 for damage or deformation.	Annual
Electrical connections	<ul style="list-style-type: none">• Cables are securely connected.• Cables are intact, in particular, the parts touching the metallic surface are not scratched.	The first inspection is 6 months after the initial commissioning. From then on, the interval can be 6 to 12 months.
Grounding reliability	Check whether the ground terminal and ground cable are securely connected.	Annual
Sealing	Check whether all terminals and ports are properly sealed.	Annual

7.2 Troubleshooting

Alarm severities are defined as follows:

- Major: The inverter is faulty. As a result, the output power decreases or the grid-tied power generation is stopped.
- Minor: Some components are faulty without affecting the grid-tied power generation.
- Warning: The inverter works properly. The output power decreases or some authorization functions fail due to external factors.

Table 7-2 Common alarms and troubleshooting measures

Alarm ID	Alarm Name	Alarm Severity	Possible Cause	Troubleshooting Suggestion
2001	High String Input Voltage	Major	The PV array is not properly configured. Excessive PV modules are connected in series to the PV string, and therefore the open-circuit voltage exceeds the maximum inverter operating voltage. Cause ID 1 = PV1 and PV2 Cause ID 2 = PV3 and PV4	Reduce the number of PV modules connected in series to the PV string until the PV string open-circuit voltage is less than or equal to the maximum inverter operating voltage. After the PV array is correctly configured, the inverter alarm disappears.
2002	DC Arc Fault	Major	The PV string power cable arcs or is in poor contact. Cause ID 1 = PV1 and PV2 Cause ID 2 = PV3 and PV4	Check that the PV string power cable does not arc and is in good contact.
2011	String Reverse Connection	Major	The PV string polarity is reversed. Cause ID 1 = PV1 Cause ID 2 = PV2 Cause ID 3 = PV3 Cause ID 4 = PV4	Check whether the PV string is reversely connected to the SUN2000. If yes, wait until the PV string current decreases below 0.5 A, set DC SWITCH to OFF , and adjust the PV string polarity.

Alarm ID	Alarm Name	Alarm Severity	Possible Cause	Troubleshooting Suggestion
2012	String Current Backfeed	Warning	<p>The number of PV modules connected in series to this PV string is insufficient. As a result, the end voltage is lower than that of other strings.</p> <p>Cause ID 1 = PV1 Cause ID 2 = PV2 Cause ID 3 = PV3 Cause ID 4 = PV4</p>	<ol style="list-style-type: none"> 1. Check whether the number of PV modules connected in series to this PV string is less than the number of PV modules connected in series to the other PV strings connected in parallel with this PV string. If yes, wait until the PV string current decreases below 0.5 A, set DC SWITCH to OFF, and adjust the number of PV modules in the PV string. 2. Check whether the PV string is shaded. 3. Check whether the open-circuit voltage of the PV string is normal.
2021	AFCI Self-Check Failure	Major	<p>Cause ID = 1, 2 AFCI check fails.</p>	<p>Turn off the AC output switch and DC input switch, and then turn them on after 5 minutes. If the fault persists, contact your dealer or Huawei technical support.</p>
2031	Phase Wire Short-Circuited to PE	Major	<p>Cause ID = 1 The impedance of the output phase wire to PE is low or the output phase wire is short-circuited to PE.</p>	<p>Check the impedance of the output phase wire to PE, locate the position with lower impedance, and rectify the fault.</p>
2032	Grid Loss	Major	<p>Cause ID = 1</p> <ul style="list-style-type: none"> • The power grid experiences an outage. • The AC power cable is disconnected or the AC circuit breaker is OFF. 	<ol style="list-style-type: none"> 1. Check that the AC voltage is normal. 2. Check that the AC power cable is connected and that the AC switch is ON.

Alarm ID	Alarm Name	Alarm Severity	Possible Cause	Troubleshooting Suggestion
2033	Grid Undervoltage	Major	Cause ID = 1 The grid voltage is below the lower threshold or the low voltage duration has lasted for more than the value specified by LVRT.	<ol style="list-style-type: none"> 1. If the alarm occurs accidentally, the power grid may be abnormal temporarily. The inverter automatically recovers after detecting that the power grid becomes normal. 2. If the alarm occurs frequently, check whether the grid voltage is within the acceptable range. If no, contact the local power operator. If yes, login to the mobile phone app, SmartLogger, or NMS to modify the grid undervoltage protection threshold with the consent of the local power operator. 3. If the fault persists, check the connection between the AC switch and the output power cable.
2034	Grid Overvoltage	Major	Cause ID = 1 The grid voltage exceeds the higher threshold or the high voltage duration has lasted for more than the value specified by HVRT.	<ol style="list-style-type: none"> 1. If the alarm occurs accidentally, the power grid may be abnormal temporarily. The inverter automatically recovers after detecting that the power grid becomes normal. 2. If the alarm occurs frequently, check whether the power grid voltage is within the acceptable range. If no, contact the local power operator. If yes, log in to the mobile app, SmartLogger, or network management system (NMS) to modify the grid overvoltage protection threshold with the consent of the local power operator. 3. Check whether the peak voltage of the power grid is too high. If the fault persists and cannot be rectified for a long time, contact the power grid operator.

Alarm ID	Alarm Name	Alarm Severity	Possible Cause	Troubleshooting Suggestion
2035	Grid Voltage Imbalance	Major	Cause ID = 1 The difference between grid phase voltages exceeds the upper threshold.	<ol style="list-style-type: none"> 1. If the alarm occurs accidentally, the power grid may be abnormal temporarily. The inverter automatically recovers after detecting that the power grid becomes normal. 2. If the alarm occurs frequently, check whether the power grid voltage is within the acceptable range. If no, contact the local power operator. 3. If the fault persists for a long time, check the connection of the AC output power cables. 4. If the AC output power cables are correctly connected, but the alarm persists and affects the energy yield of the PV plant, contact the local power operator.
2036	Grid Overfrequency	Major	Cause ID = 1 Power grid exception: The actual grid frequency is higher than the requirement of the local power grid standard.	<ol style="list-style-type: none"> 1. If the alarm occurs accidentally, the power grid may be abnormal temporarily. The inverter automatically recovers after detecting that the power grid becomes normal. 2. If the alarm occurs frequently, check whether the grid frequency is within the acceptable range. If no, contact the local power operator. If yes, log in to the mobile phone app, SmartLogger, or NMS to modify the grid underfrequency protection threshold with the consent of the local power operator.

Alarm ID	Alarm Name	Alarm Severity	Possible Cause	Troubleshooting Suggestion
2037	Grid Underfrequency	Major	Cause ID = 1 Power grid exception: The actual grid frequency is lower than the requirement of the local power grid standard.	<ol style="list-style-type: none"> 1. If the alarm occurs accidentally, the power grid may be abnormal temporarily. The inverter automatically recovers after detecting that the power grid becomes normal. 2. If the alarm occurs frequently, check whether the grid frequency is within the acceptable range. If no, contact the local power operator. If yes, log in to the mobile phone app, SmartLogger, or NMS to modify the grid underfrequency protection threshold with the consent of the local power operator.
2038	Unstable Grid Frequency	Major	Cause ID = 1 Power grid exception: The actual grid frequency change rate does not comply with the local power grid standard.	<ol style="list-style-type: none"> 1. If the alarm occurs accidentally, the power grid may be abnormal temporarily. The inverter automatically recovers after detecting that the power grid becomes normal. 2. If the alarm occurs frequently, check whether the grid frequency is within the acceptable range. If no, contact the local power operator.
2039	Output Overcurrent	Major	Cause ID = 1 The grid voltage drops dramatically or the power grid is short-circuited. As a result, the inverter transient output current exceeds the upper threshold, and inverter protection is triggered.	<ol style="list-style-type: none"> 1. The inverter monitors its external working conditions in real time. The inverter automatically recovers after the fault is rectified. 2. If the alarm occurs frequently and affects the power production of the PV plant, check whether the output is short-circuited. If the fault persists, contact your dealer or Huawei technical support.
2040	Output DC Component Overhigh	Major	Cause ID = 1 The DC component in the grid current exceeds the upper threshold.	<ol style="list-style-type: none"> 1. The inverter monitors its external working conditions in real time. The inverter automatically recovers after the fault is rectified. 2. If the alarm occurs frequently, contact your dealer or Huawei technical support.

Alarm ID	Alarm Name	Alarm Severity	Possible Cause	Troubleshooting Suggestion
2051	Abnormal Residual Current	Major	<p>Cause ID = 1</p> <p>The input-to-ground insulation impedance has decreased during the inverter operation.</p>	<ol style="list-style-type: none"> 1. If the alarm occurs accidentally, the external power cable may be abnormal temporarily. The inverter automatically recovers after the fault is rectified. 2. If the alarm occurs frequently or persists, check that the impedance between the PV string and ground is not below the lower threshold.
2061	Abnormal Grounding	Major	<p>Cause ID = 1</p> <ul style="list-style-type: none"> • The neutral wire or ground cable is not connected. • The PV array is grounded, but the inverter output does not connect to an isolation transformer. 	<p>Power off the inverter (turn off the AC output switch and DC input switch, and wait for 5 minutes), and then perform the following operations:</p> <ol style="list-style-type: none"> 1. Check that the PE cable for the inverter is connected properly. 2. If the inverter is connected to the TN power grid, check whether the N cable is properly connected and whether the voltage to ground is normal. 3. Check whether the AC output connects to an isolation transformer. If yes, after powering on the inverter, log in to the mobile phone app, SmartLogger, or NMS and disable Grounding inspection.
2062	Low Insulation Resistance	Major	<p>Cause ID = 1</p> <ul style="list-style-type: none"> • The PV array is short-circuited to ground. • The PV array is in a moist environment and the power cable is not well insulated to ground. 	<ol style="list-style-type: none"> 1. Check the impedance between the PV array output and PE, and eliminate short circuits and poor insulation points. 2. Check that the PE cable for the inverter is connected correctly. 3. If you are sure that the impedance is less than the preset protection threshold in a cloudy or rainy environment, log in to the mobile phone app, SmartLogger, or NMS and reset the insulation impedance protection threshold.

Alarm ID	Alarm Name	Alarm Severity	Possible Cause	Troubleshooting Suggestion
2063	Cabinet Overtemperature	Minor	Cause ID = 1 <ul style="list-style-type: none"> The inverter is installed in a place with poor ventilation. The ambient temperature exceeds the upper threshold. The inverter is not working properly. 	<ul style="list-style-type: none"> Check the ventilation and ambient temperature at the inverter installation position. If the ventilation is poor or the ambient temperature exceeds the upper threshold, improve the ventilation and heat dissipation. If the ventilation and ambient temperature both meet requirements, contact your dealer or Huawei technical support.
2064	Device Fault	Major	Cause ID = 1–12 An unrecoverable fault has occurred on a circuit inside the inverter.	Turn off the AC output switch and DC input switch, and then turn them on after 5 minutes. If the fault persists, contact your dealer or Huawei technical support. Note: If the cause ID is ID 1, perform the preceding operation when the PV string current is less than 1 A.
2065	Upgrade Failed or Version Mismatch	Minor	Cause ID = 1, 2 and 4 The upgrade ends abnormally. NOTE Upgrade the inverter again if it is stuck in initialization state without generating any alarms and cannot be restored to the normal state during the upgrade when the PV inputs are disconnected and reconnected next time.	<ol style="list-style-type: none"> Upgrade again. If the upgrade fails several times, contact your dealer or Huawei technical support.
2066	License Expired	Warning	Cause ID = 1 <ul style="list-style-type: none"> The privilege certificate has entered the grace period. The privilege feature will be invalid soon. 	<ol style="list-style-type: none"> Apply for a new certificate. Load the new certificate.
61440	Faulty Monitoring Unit	Minor	Cause ID = 1 <ul style="list-style-type: none"> The flash memory is insufficient. The flash memory has bad sectors. 	Turn off the AC output switch and DC input switch, and then turn them on after 5 minutes. If the fault persists, replace the monitoring board or contact your dealer Huawei technical support.

Alarm ID	Alarm Name	Alarm Severity	Possible Cause	Troubleshooting Suggestion
2067	Faulty Power Collector	Major	Cause ID = 1 Power meter disconnection.	<ol style="list-style-type: none"> 1. Check that the preset power meter model is the same as the actual model. 2. Check that the preset communications parameters for the power meter are the same as the actual configurations. 3. Check that the power meter is powered on and the RS485 communications cable is connected.
2072	Transient AC Overvoltage	Major	Cause ID = 1 The inverter detects that the phase voltage exceeds the transient AC overvoltage protection threshold.	<ol style="list-style-type: none"> 1. Check whether the grid connection voltage exceeds the upper threshold. If yes, contact the local power operator. 2. If you have confirmed that the grid connection voltage exceeds the upper threshold and obtained the consent of the local power operator, modify the overvoltage protection threshold. 3. Check that the peak grid voltage does not exceed the upper threshold.

 **NOTE**

Contact your dealer or Huawei technical support if the measures listed in the **Troubleshooting Suggestion** column have been taken but the fault persists.

8 Handling the Inverter

8.1 Removing the SUN2000

NOTICE

Before removing the SUN2000, disconnect both the AC and DC power supplies. After powering off the SUN2000, wait at least 5 minutes before performing operations on the SUN2000.

Perform the following operations to remove the SUN2000:

1. Disconnect all cables from the SUN2000, including RS485 communications cables, DC input power cables, AC output power cables, and PGND cables.
2. Remove the SUN2000 from the mounting bracket.
3. Remove the mounting bracket.

8.2 Packing the SUN2000

- If the original packing materials are available, put the SUN2000 inside them and then seal them by using adhesive tape.
- If the original packing materials are not available, put the SUN2000 inside a suitable cardboard box and seal it properly.

8.3 Disposing of the SUN2000

If the SUN2000 service life expires, dispose of it according to the local disposal rules for electrical equipment waste.

9 Technical Data

NOTICE

The SUN2000-8KTL-M0 and SUN2000-10KTL-M0 inverters are applicable only to Australia.

Efficiency

Technical Specifications	SUN2000-8KTL-M0	SUN2000-10KTL-M0	SUN2000-12KTL-M0	SUN2000-15KTL-M0	SUN2000-17KTL-M0	SUN2000-20KTL-M0
Maximum efficiency	98.5%	98.5%	98.5%	98.65%	98.65%	98.65%
European efficiency	98.0%	98.0%	98.0%	98.3%	98.3%	98.3%

Input

Technical Specifications	SUN2000-8KTL-M0	SUN2000-10KTL-M0	SUN2000-12KTL-M0	SUN2000-15KTL-M0	SUN2000-17KTL-M0	SUN2000-20KTL-M0
Maximum input voltage ^a	1080 V					
Maximum input current (per MPPT)	22 A					
Maximum short-circuit current (per MPPT)	30 A					

Technical Specifications	SUN2000-8 KTL-M0	SUN2000-10KTL-M0	SUN2000-12KTL-M0	SUN2000-15KTL-M0	SUN2000-17KTL-M0	SUN2000-20KTL-M0
Maximum inverter backfeed current to the PV array	0 A					
Minimum startup voltage	200 V					
Operating voltage range ^b	160–950 V					
Full-load MPPT voltage range	320Vdc–850 Vdc	320Vdc–850 Vdc	380–850 V	380–850 V	400–850 V	480–850 V
Rated input voltage	600 V					
Number of input routes	4					
Number of MPP trackers	2					
<p>Note a: The maximum input voltage is the upper threshold of the DC voltage. If the input voltage exceeds the threshold, the solar inverter may be damaged.</p> <p>Note b: If the input voltage is beyond the operating voltage range, the solar inverter cannot work properly.</p>						

Output

Technical Specifications	SUN2000-8 KTL-M0	SUN2000-10KTL-M0	SUN2000-12KTL-M0	SUN2000-15KTL-M0	SUN2000-17KTL-M0	SUN2000-20KTL-M0
Rated active power	8000 W	10000 W	12000 W	15000 W	17000 W	20000 W
Maximum apparent power	8800 VA	11000 VA	13200 VA	16500 VA	18700 VA	22000 VA
Maximum active power (cosφ = 1)	8800 W	11000 W	13200 W	16500 W	18700 W	22000 W
Rated output voltage	220/380 V, 230/400 V, 3W+(N)+PE					

Technical Specifications	SUN2000-8 KTL-M0	SUN2000-10KTL-M0	SUN2000-12KTL-M0	SUN2000-15KTL-M0	SUN2000-17KTL-M0	SUN2000-20KTL-M0
Rated output current	12.8 A (380 V)/11.6 A (400 V)	15.9 A (380 V)/14.5 A (400 V)	18.2 A (380 V)/17.3 A (400 V)	22.8 A (380 V)/21.7 A (400 V)	25.8 A (380 V)/24.6 A (400 V)	30.4 A (380 V)/28.9 A (400 V)
Maximum output current	13.4 A	17 A	20 A	25.2 A	28.5 A	33.5 A
Adapted power grid frequency	50/60 Hz					
Power factor	0.8 leading... 0.8 lagging					
Maximum total harmonic distortion (rated power)	< 3%					

Protection and Feature

Technical Specifications	SUN2000-8 KTL-M0	SUN2000-10KTL-M0	SUN2000-12KTL-M0	SUN2000-15KTL-M0	SUN2000-17KTL-M0	SUN2000-20KTL-M0
AFCI	Yes					
Input DC switch	Yes					
Anti-islanding protection	Yes					
Output overcurrent protection	Yes					
Output short-circuit protection	Yes					
Output overvoltage protection	Yes					
Input reverse connection protection	Yes					

Technical Specifications	SUN2000-8 KTL-M0	SUN2000-10KTL-M0	SUN2000-12KTL-M0	SUN2000-15KTL-M0	SUN2000-17KTL-M0	SUN2000-20KTL-M0
PV string fault detection	Yes					
DC surge protection	Yes					
AC surge protection	Yes					
Insulation resistance detection	Yes					
Residual current monitoring unit (RCMU)	Yes					

Display and Communication

Technical Specifications	SUN2000-8 KTL-M0	SUN2000-10KTL-M0	SUN2000-12KTL-M0	SUN2000-15KTL-M0	SUN2000-17KTL-M0	SUN2000-20KTL-M0
Display	LED indicators; WLAN+app					
RS485	Yes					
Communications expansion module	(Optional) WLAN-FE/4G					
Remote dry contact scheduling	Yes					

NOTE

When the DC input voltage of the inverter is less than 200 V, the inverter shuts down without communication.

Common Parameters

Technical Specifications	SUN2000-8 KTL-M0	SUN2000-10KTL-M0	SUN2000-12KTL-M0	SUN2000-15KTL-M0	SUN2000-17KTL-M0	SUN2000-20KTL-M0
Dimensions (W x H x D)	525mm×470mm×262mm					
Net weight	25 kg					
Operating temperature	-25 °C to +60 °C (derated at +45 °C or higher)					
Cooling mode	Natural convection					
Highest operating altitude	0–4000 m (derated above 2000 m)					
Relative humidity	0%–100% RH					
Input terminal	Amphenol Helios H4					
Output terminal	Waterproof quick-connect terminal					
IP rating	IP65					
Topology	No transformer					

A Grid Codes

 **NOTE**

The grid codes are subject to change. The listed codes are for your reference only.

Table A-1 Grid Codes

No.	Grid Codes	Description
1	VDE-AR-N-4105	Germany low-voltage power grid
2	UTE C 15-712-1 (A)	France mainland low-voltage power grid
3	UTE C 15-712-1 (B)	France island power grid (230 V 50 Hz)
4	UTE C 15-712-1 (C)	France island power grid (230 V 60 Hz)
5	VDE 0126-1-1-BU	Bulgaria low-voltage power grid
6	VDE 0126-1-1-GR (A)	Greece mainland low-voltage power grid
7	VDE 0126-1-1-GR (B)	Greece island low-voltage power grid
8	BDEW-MV	Germany medium-voltage power grid
9	G59-England	England 230 V power grid (I > 16 A)
10	G59-Scotland	Scotland 240 V power grid (I > 16 A)
11	G83-England	England 230 V power grid (I < 16 A)
12	G83-Scotland	England 240 V power grid (I < 16 A)
13	CEI0-21	Italy low-voltage power grid
14	EN50438-CZ	Czech Republic low-voltage power grid
15	RD1699/661	Spain low-voltage power grid
16	EN50438-NL	Netherlands low-voltage power grid

No.	Grid Codes	Description
17	C10/11	Belgium low-voltage power grid
18	AS4777	Australia low-voltage power grid
19	IEC61727	IEC61727 low-voltage power grid (50 Hz)
20	User-defined (50 Hz)	Reserved
21	User-defined (60 Hz)	Reserved
22	CEI0-16	Italy low-voltage power grid
23	TAI-PEA	Thailand low-voltage power grid (PEA)
24	TAI-MEA	Thailand low-voltage power grid (MEA)
25	EN50438-TR	Turkey low-voltage power grid
26	Philippines	Philippines low-voltage power grid
27	NRS-097-2-1	South Africa low-voltage power grid
28	KOREA	South Korea low-voltage power grid
29	IEC61727-60Hz	IEC61727 low-voltage power grid (60 Hz)
30	ANRE	Romania low-voltage power grid
31	EN50438_IE	Ireland low-voltage power grid
32	PO12.3	Spain low-voltage power grid
33	Egypt ETEC	Egypt medium-voltage power grid
34	CLC/TS50549_IE	Ireland low-voltage power grid
35	Jordan-Transmission	Jordan low-voltage power grid
36	NAMIBIA	Namibia low-voltage power grid
37	ABNT NBR 16149	Brazil low-voltage power grid
38	SA_RPPs	South Africa low-voltage power grid
39	INDIA	India low-voltage power grid
40	ZAMBIA	Zambia low-voltage power grid
41	Chile	Chile low-voltage power grid
42	Malaysian	Malaysia low-voltage power grid
43	KENYA_ETHIOPIA	Kenya low-voltage power grid and Ethiopia low-voltage power grid
44	NIGERIA	Nigeria low-voltage power grid

No.	Grid Codes	Description
45	DUBAI	Dubai low-voltage power grid
46	Northern Ireland	Northern Ireland low-voltage power grid
47	Cameroon	Cameroon low-voltage power grid
48	Jordan-Distribution	Jordan power distribution network low-voltage power grid
49	LEBANON	Lebanon low-voltage power grid
50	TUNISIA	Tunisia low-voltage power grid
51	AUSTRALIA-NER	Australia NER standard low-voltage power grid
52	SAUDI	Saudi Arabia low-voltage power grid
53	Israel	Israel low-voltage power grid
54	Chile-PMGD	Chile PMGD low-voltage power grid
55	VDE-AR-N4120_HV	VDE41200 standard low-voltage power grid
56	Vietnam	Vietnam low-voltage power grid
57	TAIPOWER	Taiwan, China low-voltage power grid
58	OMAN	Oman low-voltage power grid
59	KUWAIT	Kuwait low-voltage power grid
60	BANGLADESH	Bangladesh low-voltage power grid
61	CHILE_NET_BILLING	Chile Net Billing low-voltage power grid
62	BAHRAIN	Bahrain low-voltage power grid
63	Fuel-Engine-Grid	DG hybrid low-voltage power grid (50 Hz)
64	Fuel-Engine-Grid-60Hz	DG hybrid low-voltage power grid (60 Hz)
65	ARGENTINA	Argentina low-voltage power grid
66	Mauritius	Mauritius low-voltage power grid
67	EN50438-SE	Sweden low-voltage power grid
68	Austria	Austria
69	G99-TYPEA-LV	United Kingdom
70	G99-TYPEB-LV	United Kingdom

No.	Grid Codes	Description
71	G99-TYPEB-HV	United Kingdom
72	G99-TYPEA-HV	United Kingdom

B Setting Dry Contact Scheduling Parameters

Scenario 1: Smart Dongle Networking Scenario

Prerequisites

You have logged in to the app as **installer**. The initial password is **00000a**. Use the initial password upon first power-on and change it immediately after login. To ensure account security, change the password periodically and keep the new password in mind. Not changing the initial password may cause password disclosure. A password left unchanged for a long period of time may be stolen or cracked. If a password is lost, devices cannot be accessed. In these cases, the user is liable for any loss caused to the PV plant.

Procedure

Step 1 Set dry contact scheduling parameters.

NOTE

Set **Dry contact scheduling** to , and set **Active power control** and **Reactive power control**.

Figure B-1 Setting dry contact scheduling parameters

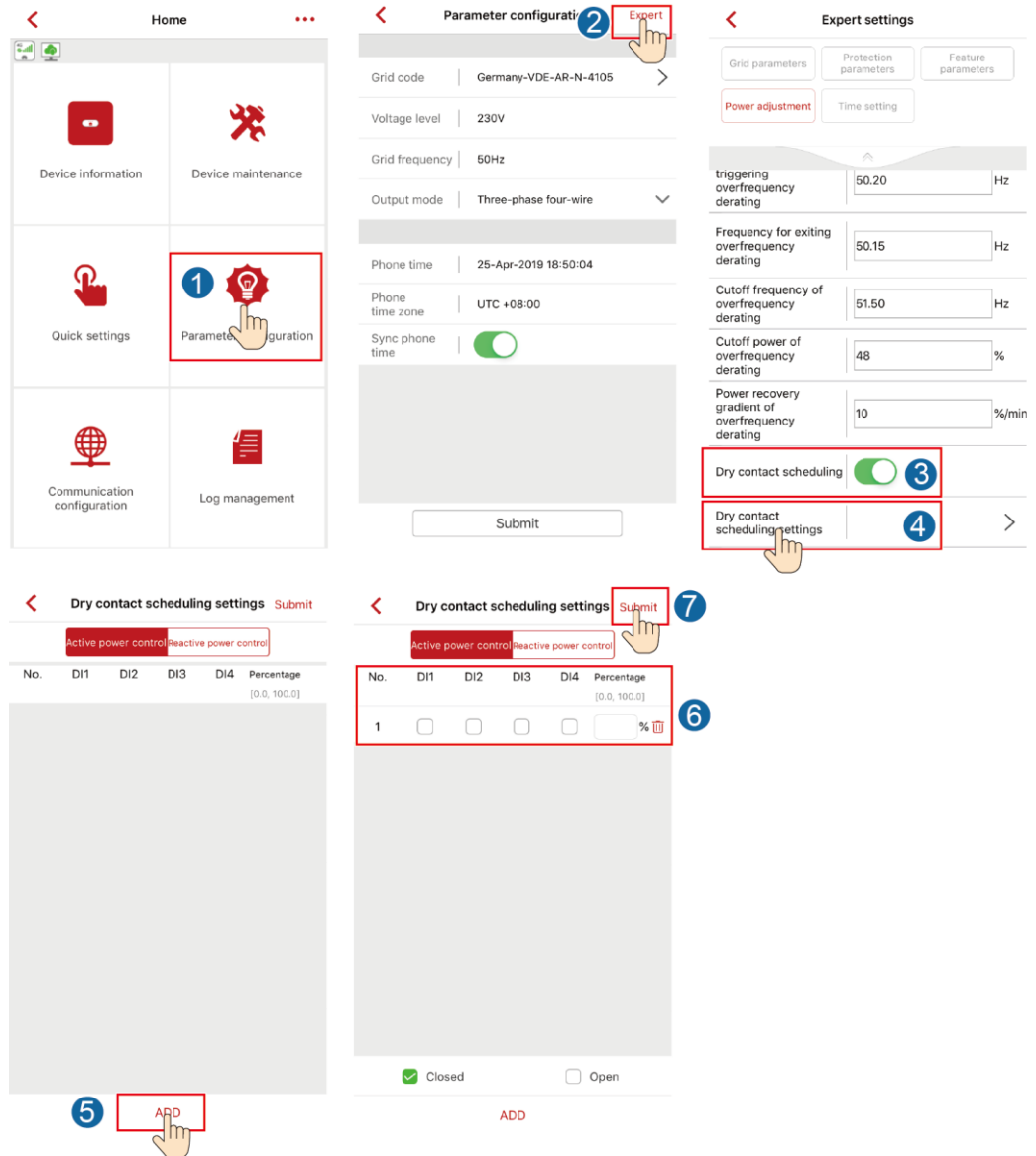

----End

Scenario 2: SmartLogger1000A Networking Scenario

See the [SmartLogger1000A User Manual](#).

You can scan the QR code to obtain it.



C Setting Export Limitation Parameters

Scenario 1: Smart Dongle Networking Scenario

Prerequisites

You have logged in to the app as **installer**. The initial password is **00000a**. Use the initial password upon first power-on and change it immediately after login. To ensure account security, change the password periodically and keep the new password in mind. Not changing the initial password may cause password disclosure. A password left unchanged for a long period of time may be stolen or cracked. If a password is lost, devices cannot be accessed. In these cases, the user is liable for any loss caused to the PV plant.

Procedure

Step 1 Set export limitation parameters.

Figure C-1 Setting export limitation parameters

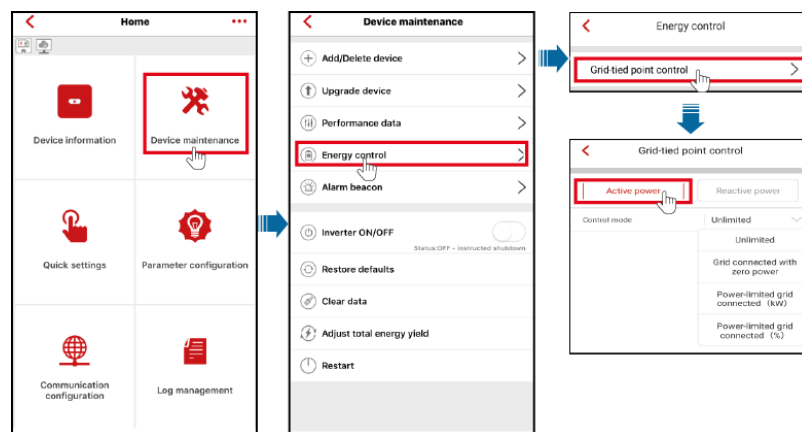

Table C-1 Control mode

Parameter			Description
Unlimited	-	-	If this parameter is set to Unlimited , the inverter output power is not limited. The inverter can export its rated power to the power grid.
Grid connected with zero power	Closed-loop controller	<ul style="list-style-type: none"> • SDongle/SmartLogger • Inverter 	<ul style="list-style-type: none"> • Set this parameter to SDongle/SmartLogger when the SmartLogger1000A is connected. • If multiple inverters are cascaded, set this parameter to SDongle/SmartLogger. • If there is only one inverter, set this parameter to Inverter.
	Limitation mode	<ul style="list-style-type: none"> • Total power • Single-phase power 	<ul style="list-style-type: none"> • If this parameter is set to Total power, it indicates that no backfeeding occurs for the three phases. • If this parameter is set to Single-phase power, it indicates that no backfeeding occurs for the phase with the maximum power.
	Power lowering adjustment period	-	Specifies the shortest interval for a single anti-backfeeding adjustment.
	Maximum protection time	-	Specifies the time for detecting meter data. If the Dongle does not detect any meter data within the preset time, the Dongle delivers the preset value of the Active power output limit for fail-safe to the inverter for protection.
	Power raising threshold	-	Specifies the threshold for raising the inverter output power.
	Communication disconnection fail-safe	<ul style="list-style-type: none"> • Disable • Enable 	In the inverter anti-backfeeding scenario, if this parameter is set to Enable , the inverter will derate according to the active power derating percentage when the communication between the inverter and the Dongle is disconnected for a period longer than Communication disconnection detection time .

Parameter		Description	
	Communication disconnection detection time	-	Specifies the time for determining the communication disconnection between the solar inverter and the Dongle.
	Active power output limit for fail-safe	-	Specifies the derating value of the inverter active power by percentage. If the Dongle does not detect any meter data or the communication between the Dongle and the inverter is disconnected, the Dongle delivers the derating value of the inverter active power by percentage.
Power-limited grid connected (kW)	Closed-loop controller	<ul style="list-style-type: none"> • SDongle/SmartLogger • Inverter 	<ul style="list-style-type: none"> • Set this parameter to SDongle/SmartLogger when the SmartLogger1000A is connected. • If multiple inverters are cascaded, set this parameter to SDongle/SmartLogger. • If there is only one inverter, set this parameter to Inverter.
	Limitation mode	<ul style="list-style-type: none"> • Total power • Single-phase power 	<ul style="list-style-type: none"> • If this parameter is set to Total power, it indicates that no backfeeding occurs for the three phases. • If this parameter is set to Single-phase power, it indicates that no backfeeding occurs for the phase with the maximum power.
	PV plant capacity	-	Specifies the total maximum active power in the inverter cascading scenario.
	Maximum grid feed-in power (kW)	-	Specifies the maximum active power transmitted from the grid-tied point to the power grid.
	Power lowering adjustment period	-	Specifies the shortest interval for a single anti-backfeeding adjustment.
	Maximum protection time	-	Specifies the time for detecting meter data. If the Dongle does not detect any meter data within the preset time, the Dongle delivers the preset value of the Active power output limit for fail-safe to the inverter for protection.

Parameter			Description
	Power raising threshold	-	Specifies the threshold for raising the inverter output power.
	Communication disconnection fail-safe	<ul style="list-style-type: none"> • Disable • Enable 	In the inverter anti-backfeeding scenario, if this parameter is set to Enable , the inverter will derate according to the active power derating percentage when the communication between the inverter and the Dongle is disconnected for a period longer than Communication disconnection detection time .
	Communication disconnection detection time	-	Specifies the time for determining the communication disconnection between the solar inverter and the Dongle.
	Active power output limit for fail-safe	-	Specifies the derating value of the inverter active power by percentage. If the Dongle does not detect any meter data or the communication between the Dongle and the inverter is disconnected, the Dongle delivers the derating value of the inverter active power by percentage.
Power-limited grid connected (%)	Closed-loop controller	<ul style="list-style-type: none"> • SDongle/SmartLogger • Inverter 	<ul style="list-style-type: none"> • Set this parameter to SDongle/SmartLogger when the SmartLogger1000A is connected. • If multiple inverters are cascaded, set this parameter to SDongle/SmartLogger. • If there is only one inverter, set this parameter to Inverter.
	Limitation mode	<ul style="list-style-type: none"> • Total power • Single-phase power 	<ul style="list-style-type: none"> • If this parameter is set to Total power, it indicates that no backfeeding occurs for the three phases. • If this parameter is set to Single-phase power, it indicates that no backfeeding occurs for the phase with the maximum power.
	PV plant capacity	-	Specifies the total maximum active power in the inverter cascading scenario.

Parameter		Description
Maximum grid feed-in power (%)	-	Specifies the percentage of the maximum active power of the grid-tied point to the PV plant capacity.
Power lowering adjustment period	-	Specifies the shortest interval for a single anti-backfeeding adjustment.
Maximum protection time	-	Specifies the time for detecting meter data. If the Dongle does not detect any meter data within the preset time, the Dongle delivers the preset value of the Active power output limit for fail-safe to the inverter for protection.
Power raising threshold	-	Specifies the threshold for raising the inverter output power.
Communication disconnection fail-safe	<ul style="list-style-type: none"> • Disable • Enable 	In the inverter anti-backfeeding scenario, if this parameter is set to Enable , the inverter will derate according to the active power derating percentage when the communication between the inverter and the Dongle is disconnected for a period longer than Communication disconnection detection time .
Communication disconnection detection time	-	Specifies the time for determining the communication disconnection between the solar inverter and the Dongle.
Active power output limit for fail-safe	-	Specifies the derating value of the inverter active power by percentage. If the Dongle does not detect any meter data or the communication between the Dongle and the inverter is disconnected, the Dongle delivers the derating value of the inverter active power by percentage.

----End

Scenario 2: SmartLogger1000A Networking Scenario

See the [SmartLogger1000A User Manual](#).

You can scan the QR code to obtain it.



D Setting Voltage Rise Suppression Q-U Curve

Scenario 1: Smart Dongle Networking Scenario

Prerequisites

You have logged in to the app as **installer**. The initial password is **00000a**. Use the initial password upon first power-on and change it immediately after login. To ensure account security, change the password periodically and keep the new password in mind. Not changing the initial password may cause password disclosure. A password left unchanged for a long period of time may be stolen or cracked. If a password is lost, devices cannot be accessed. In these cases, the user is liable for any loss caused to the PV plant.

Procedure

Step 1 Set voltage rise suppression Q-U curve parameters.

Figure D-1 Setting voltage rise suppression Q-U curve parameters

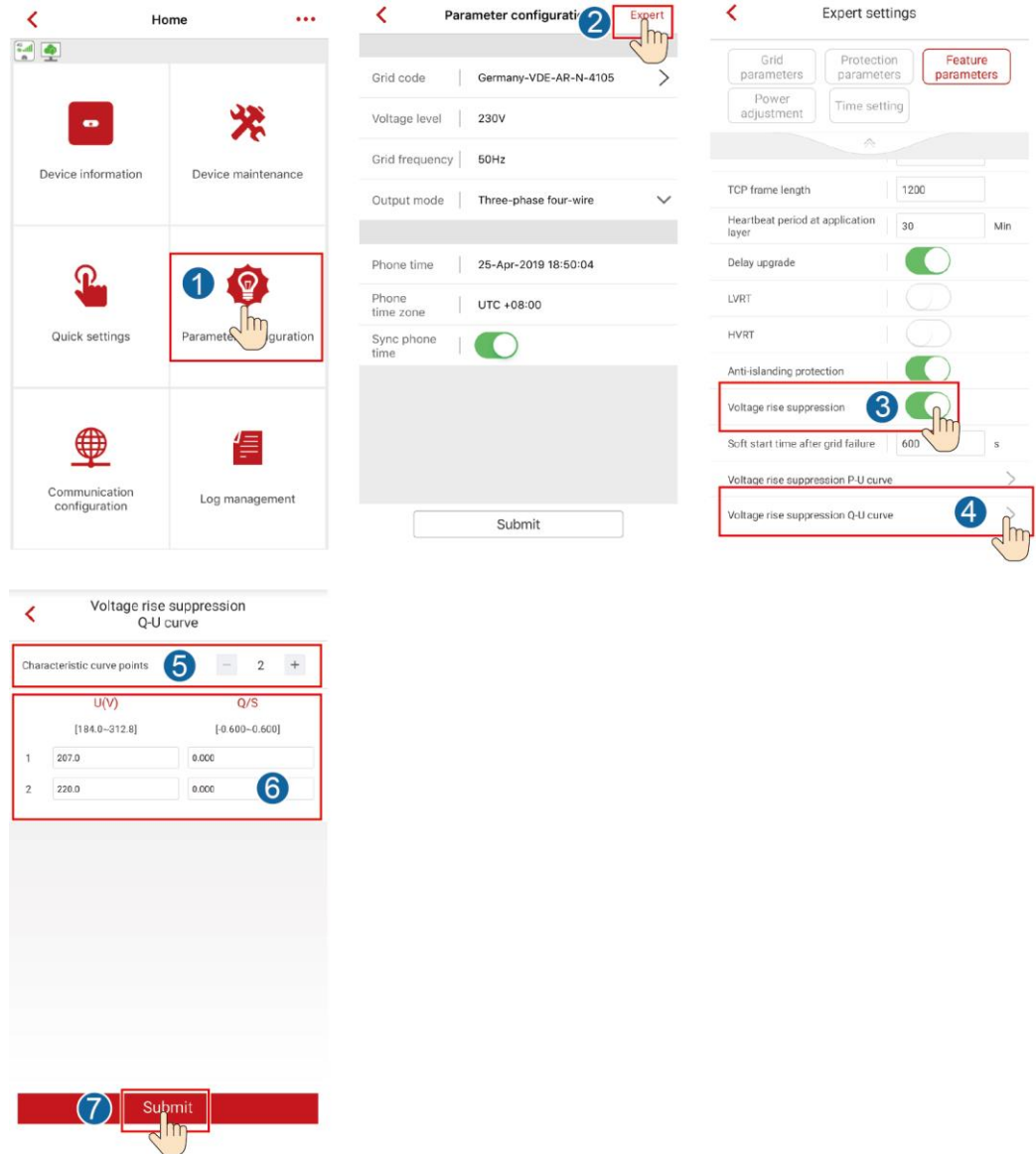

----End

Scenario 2: SmartLogger1000A Networking Scenario

See the [SmartLogger1000A User Manual](#).

You can scan the QR code to obtain it.



E Starting AFCI Check

Prerequisites

You have logged in to the app as **installer**. The initial password is **00000a**. Use the initial password upon first power-on and change it immediately after login. To ensure account security, change the password periodically and keep the new password in mind. Not changing the initial password may cause password disclosure. A password left unchanged for a long period of time may be stolen or cracked. If a password is lost, devices cannot be accessed. In these cases, the user is liable for any loss caused to the PV plant.

Procedure

- Step 1** On the **Home** screen, choose **Device maintenance** > **Start AFCI check** and perform the required operation.

Figure E-1 Start AFCI check

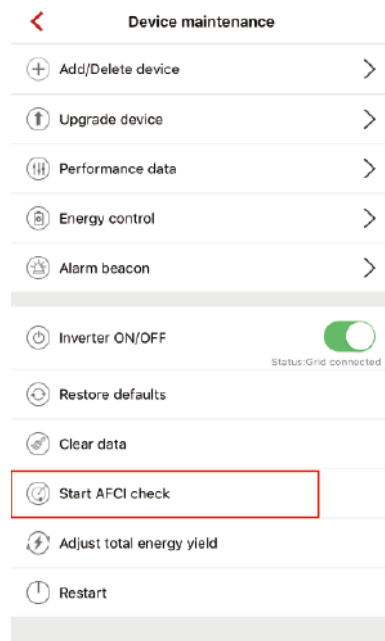

----End

F IPS Test (for Italy CEI0-21 Grid Code only)

Prerequisites

You have logged in to the app as **installer**. The initial password is **00000a**. Use the initial password upon first power-on and change it immediately after login. To ensure account security, change the password periodically and keep the new password in mind. Not changing the initial password may cause password disclosure. A password left unchanged for a long period of time may be stolen or cracked. If a password is lost, devices cannot be accessed. In these cases, the user is liable for any loss caused to the PV plant.

Context

The Italy CEI0-21 grid code requires an IPS test for the SUN2000. During the IPS test process, the SUN2000 consecutively tests the protection thresholds and time for 10-min overvoltage, level 1 overvoltage, level 1 undervoltage, level 1 overfrequency, and level 1 underfrequency. The SUN2000 shuts down after the IPS test starts, and it restarts after the IPS test is successful.

Procedure

Step 1 On the **Home** screen, choose **Device maintenance** > **IPS test** to access the IPS test screen.



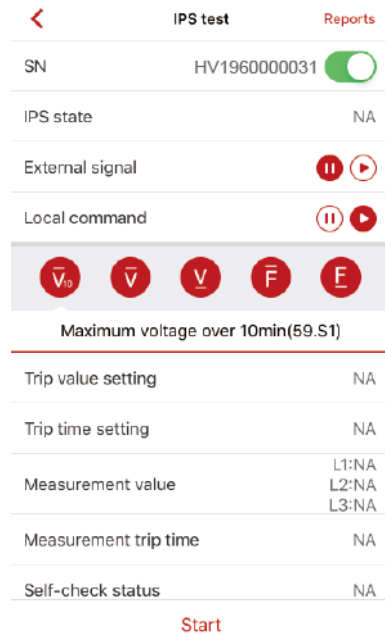

Figure F-1 IPS test



Step 2 Choose to start the S1 or S2 check as required. The default check type is S2. To start the S2 check, you need to set **External Signal** or **Local Command**.

Table F-1 IPS test type description

IPS Test Type	Description	External Signal Setting	Local Command Setting
S1	The level 1 overfrequency protection threshold is 50.5 Hz and the level 1 underfrequency protection threshold is 49.5 Hz.		
S2	The level 1 overfrequency protection threshold is 51.5 Hz and the level 1 underfrequency protection threshold is 47.5 Hz.		

IPS Test Type	Description	External Signal Setting	Local Command Setting
S2 (default)	The level 1 overfrequency protection threshold is 51.5 Hz and the level 1 underfrequency protection threshold is 47.5 Hz.		
S2	The level 1 overfrequency protection threshold is 51.5 Hz and the level 1 underfrequency protection threshold is 47.5 Hz.		

Step 3 Tap **Start** to start the IPS test. After the IPS test is complete, **IPS State** is displayed as **IPS state success**. Tap **Reports** in the upper right corner of the **IPS test** screen to view **IPS Self-Check Report**.

----End

G Acronyms and Abbreviations

A

ACDU	alternating current distribution unit
AFCI	arc-fault circuit interrupter

L

LED	light emitting diode
------------	----------------------

M

MPP	maximum power point
MPPT	maximum power point tracking

P

PV	photovoltaic
-----------	--------------

R

RCD	residual current device
------------	-------------------------

W

WEEE	waste electrical and electronic equipment
-------------	---