

# **User Manual**

## **3KW/5KW INVERTER / CHARGER**

# Table Of Contents

|                                                         |           |
|---------------------------------------------------------|-----------|
| <b>ABOUT THIS MANUAL .....</b>                          | <b>1</b>  |
| Purpose.....                                            | 1         |
| Scope.....                                              | 1         |
| <b>SAFETY INSTRUCTIONS.....</b>                         | <b>1</b>  |
| <b>INTRODUCTION .....</b>                               | <b>2</b>  |
| Features.....                                           | 2         |
| Basic System Architecture .....                         | 2         |
| Product Overview.....                                   | 3         |
| <b>INSTALLATION .....</b>                               | <b>4</b>  |
| Unpacking and Inspection.....                           | 4         |
| Preparation .....                                       | 4         |
| Mounting the Unit.....                                  | 4         |
| Battery Connection .....                                | 5         |
| AC Input/Output Connection .....                        | 6         |
| PV Connection .....                                     | 7         |
| Final Assembly.....                                     | 8         |
| Remote Display Panel Installation .....                 | 9         |
| Communication Connection.....                           | 10        |
| Dry Contact Signal .....                                | 10        |
| <b>OPERATION.....</b>                                   | <b>11</b> |
| Power ON/OFF .....                                      | 11        |
| Operation and Display Panel .....                       | 11        |
| LCD Display Icons .....                                 | 12        |
| LCD Setting.....                                        | 14        |
| Display Setting .....                                   | 24        |
| Operating Mode Description .....                        | 29        |
| Fault Reference Code.....                               | 31        |
| Warning Indicator.....                                  | 31        |
| Battery Equalization .....                              | 32        |
| <b>SPECIFICATIONS .....</b>                             | <b>34</b> |
| Table 1 Line Mode Specifications .....                  | 34        |
| Table 2 Battery Mode Specifications .....               | 35        |
| Table 3 Charge Mode Specifications .....                | 36        |
| Table 4 ECO/Bypass Mode Specifications.....             | 37        |
| <b>TROUBLE SHOOTING .....</b>                           | <b>38</b> |
| <b>PARALLEL FUNCTION .....</b>                          | <b>39</b> |
| <b>Appendix I: Approximate Back-up Time Table .....</b> | <b>54</b> |

# ABOUT THIS MANUAL

## Purpose

This manual describes the assembly, installation, operation and troubleshooting of this unit. Please read this manual carefully before installations and operations. Keep this manual for future reference.

## Scope

This manual provides safety and installation guidelines as well as information on tools and wiring.

# SAFETY INSTRUCTIONS



**WARNING: This chapter contains important safety and operating instructions. Read and keep this manual for future reference.**

1. Before using the unit, read all instructions and cautionary markings on the unit, the batteries and all appropriate sections of this manual.
2. **CAUTION** --To reduce risk of injury, charge only deep-cycle lead acid type rechargeable batteries. Other types of batteries may burst, causing personal injury and damage.
3. Do not disassemble the unit. Take it to a qualified service center when service or repair is required. Incorrect re-assembly may result in a risk of electric shock or fire.
4. To reduce risk of electric shock, disconnect all wirings before attempting any maintenance or cleaning. Turning off the unit will not reduce this risk.
5. **CAUTION** – Only qualified personnel can install this device with battery.
6. **NEVER** charge a frozen battery.
7. For optimum operation of this inverter/charger, please follow required spec to select appropriate cable size. It's very important to correctly operate this inverter/charger.
8. Be very cautious when working with metal tools on or around batteries. A potential risk exists to drop a tool to spark or short circuit batteries or other electrical parts and could cause an explosion.
9. Please strictly follow installation procedure when you want to disconnect AC or DC terminals. Please refer to INSTALLATION section of this manual for the details.
10. Fuses are provided as over-current protection for the battery supply.
11. GROUNDING INSTRUCTIONS -This inverter/charger should be connected to a permanent grounded wiring system. Be sure to comply with local requirements and regulation to install this inverter.
12. NEVER cause AC output and DC input short circuited. Do NOT connect to the mains when DC input short circuits.
13. **Warning!!** Only qualified service persons are able to service this device. If errors still persist after following troubleshooting table, please send this inverter/charger back to local dealer or service center for maintenance.

# INTRODUCTION

This is a multi-function inverter/charger, combining functions of inverter, MPPT solar charger and battery charger to offer uninterruptible power support with portable size. Its comprehensive LCD display offers user-configurable and easy-accessible button operation such as battery charging current, AC/solar charger priority, and acceptable input voltage based on different applications.

## Features

- Pure sine wave inverter
- Built-in MPPT solar charge controller
- Configurable input voltage range for home appliances and personal computers via LCD setting
- Configurable battery charging current based on applications via LCD setting
- Configurable AC/Solar Charger priority via LCD setting
- Compatible to mains voltage or generator power
- Auto restart while AC is recovering
- Overload/ Over temperature/ short circuit protection
- Smart battery charger design for optimized battery performance
- Cold start function
- Zero-transfer Time

## Basic System Architecture

The following illustration shows basic application for this inverter/charger. It also includes following devices to have a complete running system:

- Generator or Utility.
- PV modules

Consult with your system integrator for other possible system architectures depending on your requirements. This inverter can power all kinds of appliances in home or office environment, including motor-type appliances such as tube light, fan, refrigerator and air conditioner.

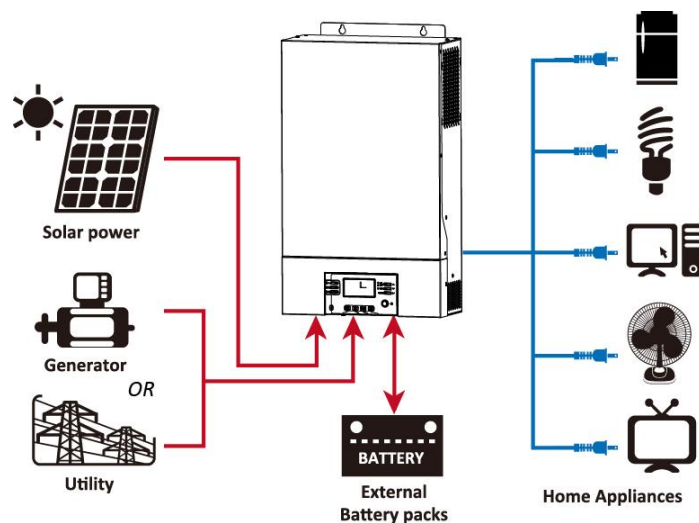
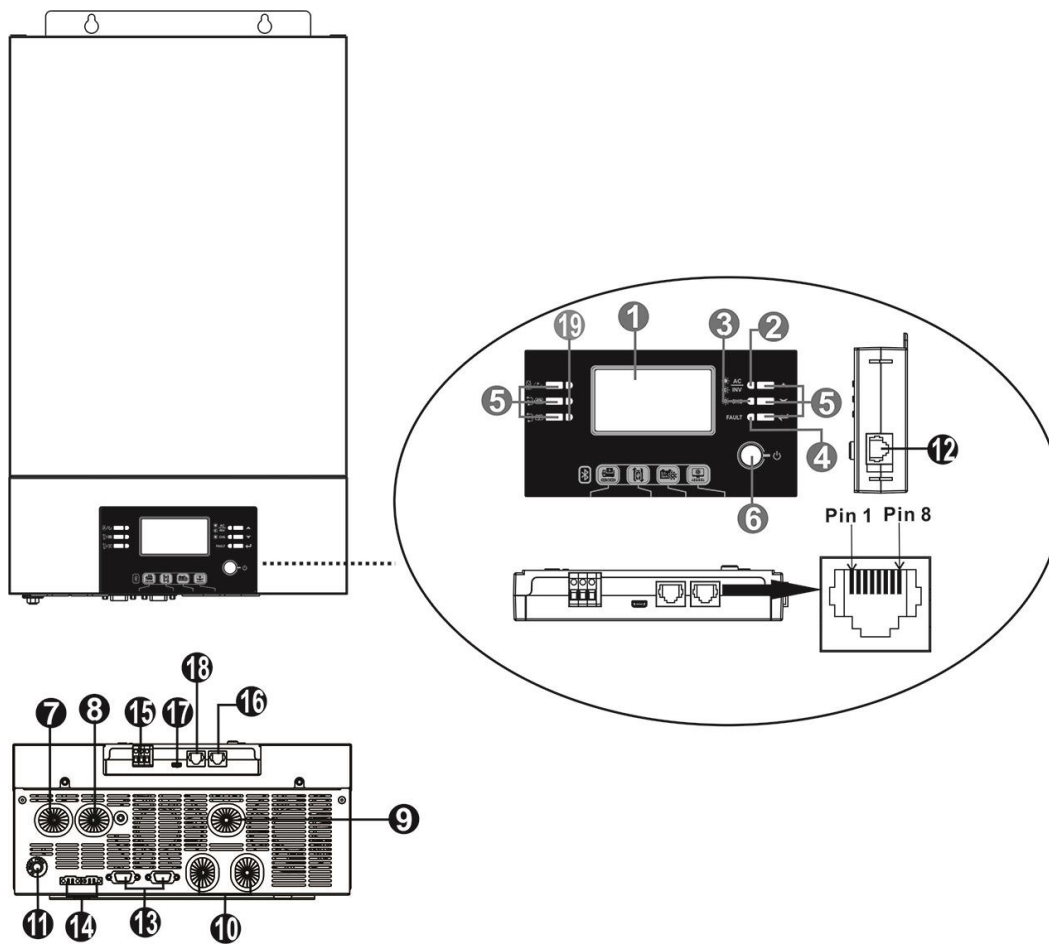

Figure 1 Hybrid Power System

# Product Overview



- 1. LCD display
- 2. Status indicator
- 3. Charging indicator
- 4. Fault indicator
- 5. Function buttons
- 6. Power on/off switch
- 7. AC input
- 8. AC output
- 9. PV input
- 10. Battery input
- 11. Circuit breaker
- 12. Remote LCD panel communication port
- 13. Parallel communication cable (only for parallel model)
- 14. Current sharing cable (only for parallel model)
- 15. Dry contact
- 16. RS-232 communication port
- 17. USB port
- 18. Reserved for future use
- 19. LED indicator for USB function settings

**NOTE:** For parallel model installation and operation, please check separate parallel installation guide for the details.

# INSTALLATION

## Unpacking and Inspection

Before installation, please inspect the unit. Be sure that nothing inside the package is damaged. You should have received the following items inside of package:

- The unit x 1
- User manual x 1
- Communication cable x 1
- Software CD x 1

## Preparation

Before connecting all wirings, please take off bottom cover by removing two screws as shown below.

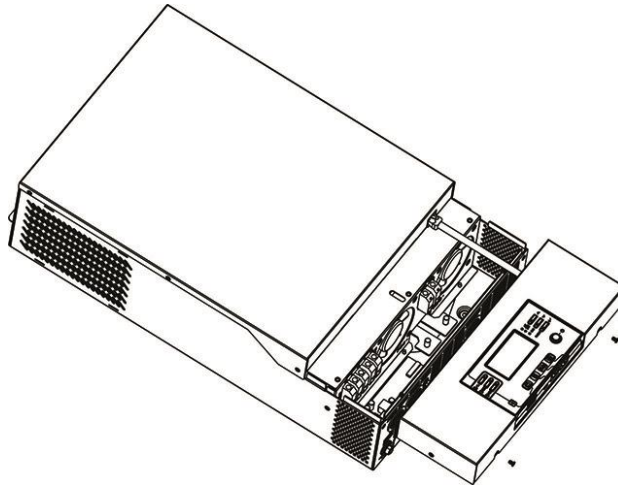

## Mounting the Unit

Consider the following points before selecting where to install:

- Do not mount the inverter on flammable construction materials.
- Mount on a solid surface
- Install this inverter at eye level in order to allow the LCD display to be read at all times.
- The ambient temperature should be between 0°C and 55°C to ensure optimal operation.
- The recommended installation position is to be adhered to the wall vertically.
- Be sure to keep other objects and surfaces as shown in the right diagram to guarantee sufficient heat dissipation and to have enough space for removing wires.

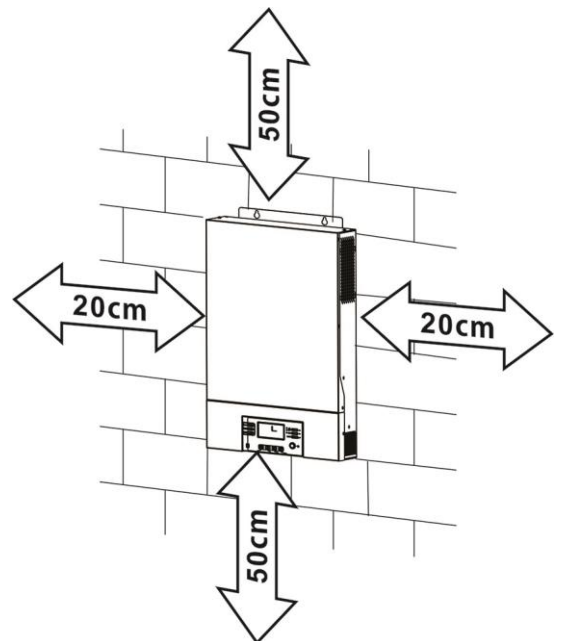

**SUITABLE FOR MOUNTING ON CONCRETE OR OTHER NON-COMBUSTIBLE SURFACE ONLY.**

Install the unit by screwing three screws. It's recommended to use M4 or M5 screws.

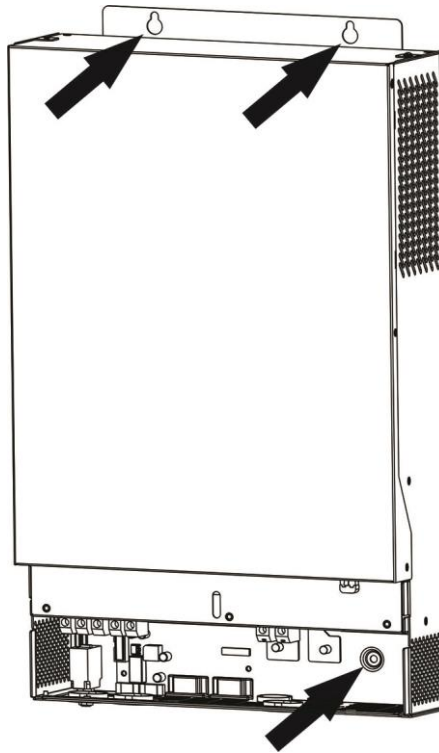

## Battery Connection

**CAUTION:** For safety operation and regulation compliance, it's requested to install a separate DC over-current protector or disconnect device between battery and inverter. It may not be requested to have a disconnect device in some applications, however, it's still requested to have over-current protection installed. Please refer to typical amperage in below table as required fuse or breaker size.

**WARNING!** All wiring must be performed by a qualified personnel.

**WARNING!** It's very important for system safety and efficient operation to use appropriate cable for battery connection. To reduce risk of injury, please use the proper recommended cable and terminal size as below.

**Ring terminal:**

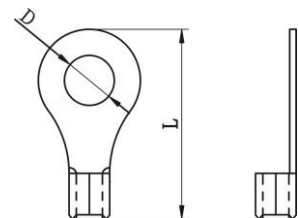

**Recommended battery cable and terminal size:**

| Model | Typical Amperage | Battery Capacity | Wire Size | Ring Terminal         |            |        | Torque Value |
|-------|------------------|------------------|-----------|-----------------------|------------|--------|--------------|
|       |                  |                  |           | Cable mm <sup>2</sup> | Dimensions |        |              |
|       |                  |                  |           |                       | D (mm)     | L (mm) |              |
| 3KW   | 200A             | 200AH            | 1*1/0AWG  | 60                    | 6.4        | 49.7   | 2~3 Nm       |
|       |                  |                  | 2*4AWG    | 44                    | 6.4        | 49.7   |              |
| 5KW   | 200A             | 200AH            | 1*1/0AWG  | 60                    | 6.4        | 49.7   | 2~3 Nm       |
|       |                  |                  | 2*4AWG    | 44                    | 6.4        | 49.7   |              |

Please follow below steps to implement battery connection:

1. Assemble battery ring terminal based on recommended battery cable and terminal size.
2. Connect all battery packs as units requires. It's suggested to connect at least 200Ah capacity battery for 3KW model and at least 200Ah capacity battery for 5KW model.
3. Insert the ring terminal of battery cable flatly into battery connector of inverter and make sure the bolts are tightened with torque of 2-3 Nm. Make sure polarity at both the battery and the inverter/charge is correctly connected and ring terminals are tightly screwed to the battery terminals.

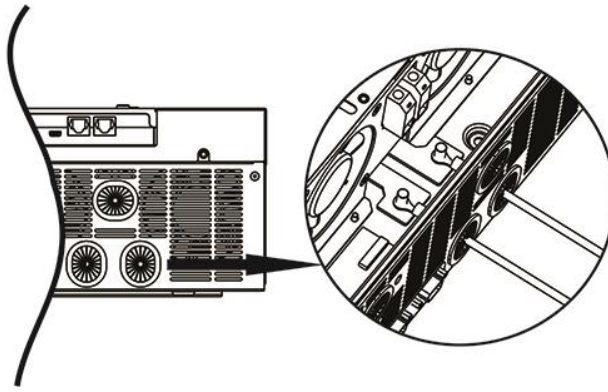

**WARNING: Shock Hazard**  
Installation must be performed with care due to high battery voltage in series.

**CAUTION!!** Do not place anything between the flat part of the inverter terminal and the ring terminal. Otherwise, overheating may occur.  
**CAUTION!!** Do not apply anti-oxidant substance on the terminals before terminals are connected tightly.  
**CAUTION!!** Before making the final DC connection or closing DC breaker/disconnector, be sure positive (+) must be connected to positive (+) and negative (-) must be connected to negative (-).

## AC Input/Output Connection

**CAUTION!!** Before connecting to AC input power source, please install a **separate** AC breaker between inverter and AC input power source. This will ensure the inverter can be securely disconnected during maintenance and fully protected from over current of AC input. The recommended spec of AC breaker is 30A for 3KW, 50A for 5KW.

**CAUTION!!** There are two terminal blocks with "IN" and "OUT" markings. Please do NOT mis-connect input and output connectors.

**WARNING!** All wiring must be performed by a qualified personnel.

**WARNING!** It's very important for system safety and efficient operation to use appropriate cable for AC input connection. To reduce risk of injury, please use the proper recommended cable size as below.

### Suggested cable requirement for AC wires

| Model | Gauge  | Torque Value |
|-------|--------|--------------|
| 3KW   | 10 AWG | 1.2~ 1.6 Nm  |
| 5KW   | 8 AWG  | 1.4~ 1.6Nm   |

Please follow below steps to implement AC input/output connection:

1. Before making AC input/output connection, be sure to open DC protector or disconnecter first.
2. Remove insulation sleeve 10mm for six conductors. And shorten phase L and neutral conductor N 3 mm.
3. Insert AC input wires according to polarities indicated on terminal block and tighten the terminal screws. Be sure to connect PE protective conductor (⊕) first.

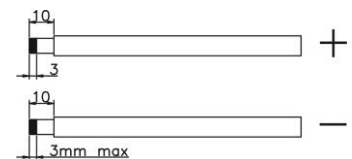

⊕ → **Ground (yellow-green)**

L → **LINE (brown or black)**

N → **Neutral (blue)**



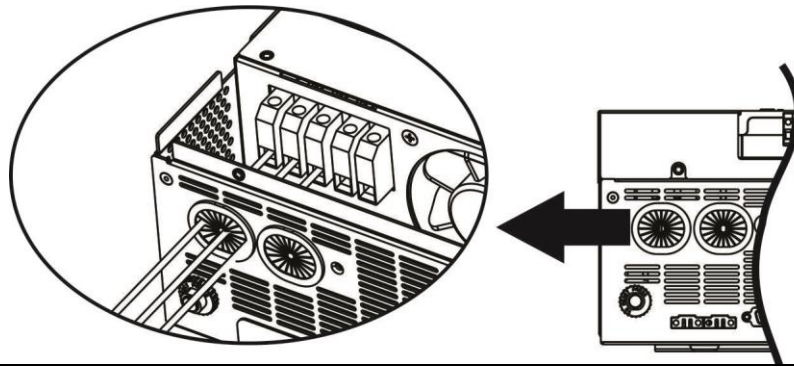

**WARNING:**

Be sure that AC power source is disconnected before attempting to hardwire it to the unit.

4. Then, insert AC output wires according to polarities indicated on terminal block and tighten terminal screws.

Be sure to connect PE protective conductor (⊕) first.

⊕ → **Ground (yellow-green)**

**L** → **LINE (brown or black)**

**N** → **Neutral (blue)**

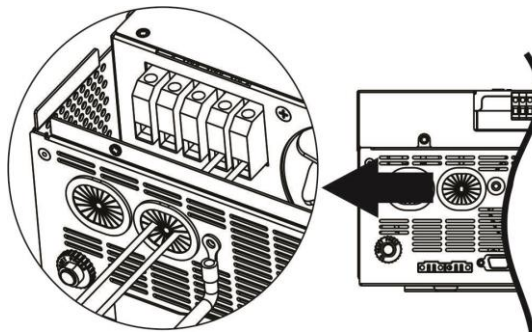

5. Make sure the wires are securely connected.

**CAUTION: Important**

Be sure to connect AC wires with correct polarity. If L and N wires are connected reversely, it may cause utility short-circuited when these inverters are worked in parallel operation.

**CAUTION:** Appliances such as air conditioner are required at least 2~3 minutes to restart because it's required to have enough time to balance refrigerant gas inside of circuits. If a power shortage occurs and recovers in a short time, it will cause damage to your connected appliances. To prevent this kind of damage, please check manufacturer of air conditioner if it's equipped with time-delay function before installation. Otherwise, this inverter/charger will trig overload fault and cut off output to protect your appliance but sometimes it still causes internal damage to the air conditioner.

## PV Connection

**CAUTION:** Before connecting to PV modules, please install **separately** a DC circuit breaker between inverter and PV modules.

**WARNING!** All wiring must be performed by a qualified personnel.

**WARNING!** It's very important for system safety and efficient operation to use appropriate cable for PV module connection. To reduce risk of injury, please use the proper recommended cable size as below.

| Model | Typical Amperage | Cable Size | Torque     |
|-------|------------------|------------|------------|
| 3KW   | 60A              | 6 AWG      | 1.2~1.6 Nm |
| 5KW   | 80A              |            |            |

### PV Module Selection:

When selecting proper PV modules, please be sure to consider below parameters:

1. Open circuit Voltage (Voc) of PV modules not exceeds max. PV array open circuit voltage of inverter.
2. Open circuit Voltage (Voc) of PV modules should be higher than min. battery voltage.

| Solar Charging Mode                |           |           |
|------------------------------------|-----------|-----------|
| INVERTER MODEL                     | 3KW       | 5KW       |
| Max. PV Array Open Circuit Voltage | 145Vdc    |           |
| PV Array MPPT Voltage Range        | 30~115Vdc | 60~115Vdc |

Please follow below steps to implement PV module connection:

1. Remove insulation sleeve 10 mm for positive and negative conductors.
2. Check correct polarity of connection cable from PV modules and PV input connectors. Then, connect positive pole (+) of connection cable to positive pole (+) of PV input connector. Connect negative pole (-) of connection cable to negative pole (-) of PV input connector.

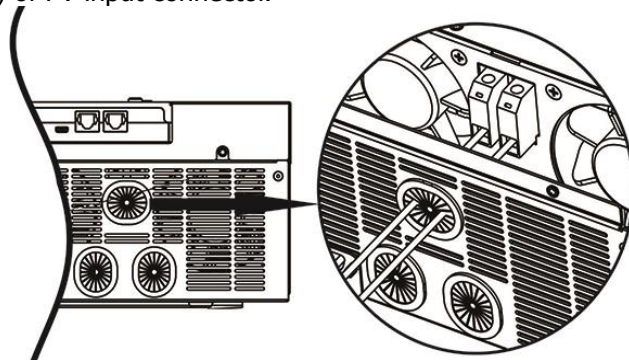
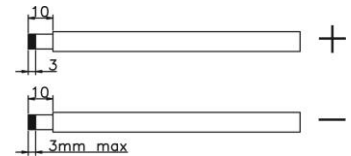

3. Make sure the wires are securely connected.

### Final Assembly

After connecting all wirings, please put bottom cover back by screwing two screws as shown on the right chart.

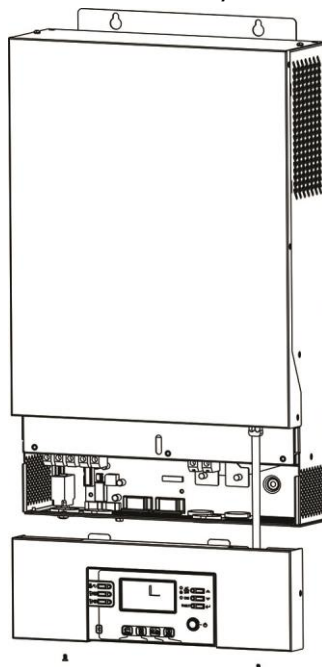

# Remote Display Panel Installation

The LCD panel can be removable and installed in a remote site with an optional communication cable. Please follow below steps to implement this remote panel installation.

**Step 1.** Loosen the screw on the two sides of bottom case and push up the case cover. Then, remove screw on the top of the display panel. Now, the display can be removed from the bottom case. Then, pull out the cable from the remote communication port.

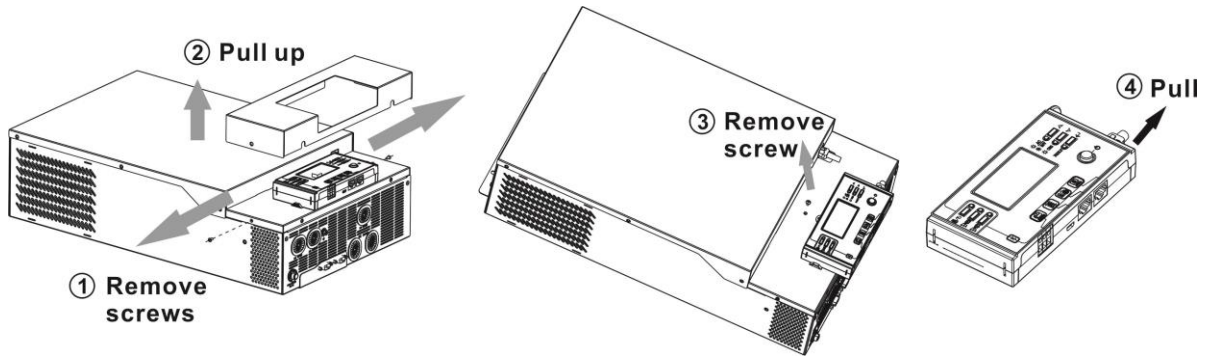

**Step 2.** Drill two holes in the marked locations with two screws as shown below chart. Place the panel on the surface and align the mounting holes with the two screws. Then, use one more screw on the top to fix the panel to the wall and check if the remote panel is firmly secured.

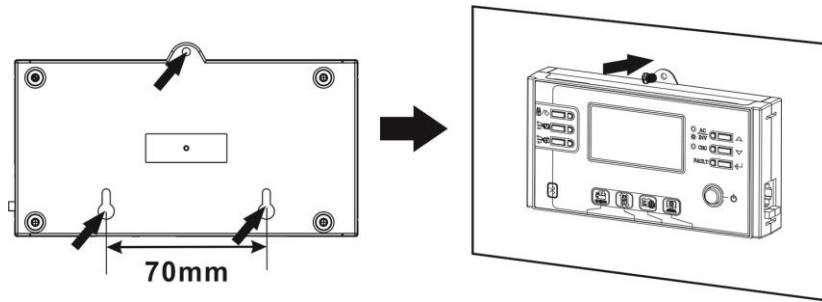

**Note:** Installation to the wall should be implemented with the proper screws. Refer chart for recommended spec of screws.

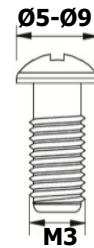

**Step 3.** Connect LCD panel to the inverter with an optional RJ45 communication cable as below chart.

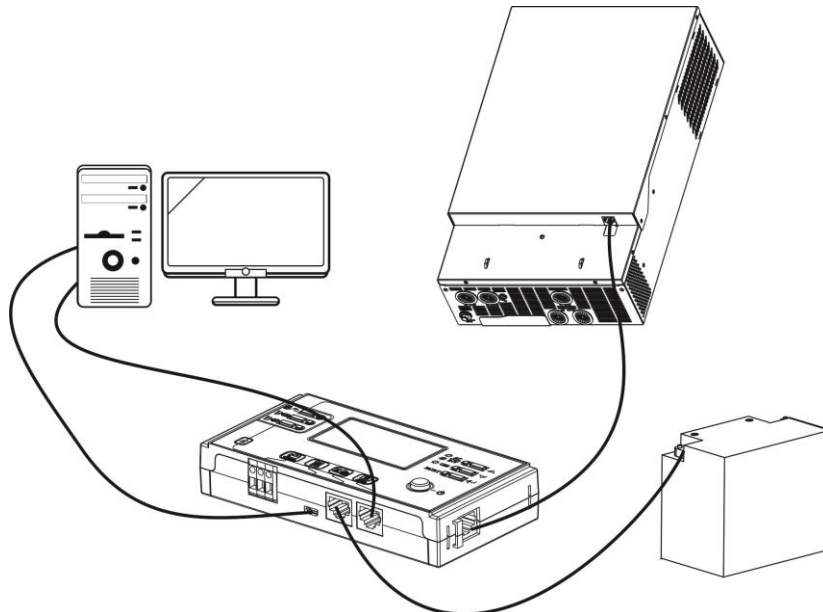

# Communication Connection

## Serial Connection

Please use supplied communication cable to connect to inverter and PC. Insert bundled CD into a computer and follow on-screen instruction to install the monitoring software. For the detailed software operation, please check user manual of software inside of CD.

## Bluetooth Connection

This series is built in Bluetooth technology. You may simply go to google play to install "WatchPower". It allows wireless communication up to 6~7m in an open space.



## Dry Contact Signal

There is one dry contact (3A/250VAC) available on the rear panel. It could be used to deliver signal to external device when battery voltage reaches warning level.

| Unit Status                                                                              | Condition                                             |                                                              | Dry contact port:  |        |       |
|------------------------------------------------------------------------------------------|-------------------------------------------------------|--------------------------------------------------------------|---------------------------------------------------------------------------------------------------------|--------|-------|
|                                                                                          |                                                       |                                                              | NC & C                                                                                                  | NO & C |       |
| Power Off                                                                                | Unit is off and no output is powered.                 |                                                              | Close                                                                                                   | Open   |       |
| Power On                                                                                 | Output is powered from Utility.                       |                                                              | Close                                                                                                   | Open   |       |
|                                                                                          | Output is powered from Battery power or Solar energy. | Program 01 set as USB (utility first)                        | Battery voltage < Low DC warning voltage                                                                | Open   | Close |
|                                                                                          |                                                       |                                                              | Battery voltage > Setting value in Program 13 or battery charging reaches floating stage                | Close  | Open  |
|                                                                                          | Output is powered from Battery power or Solar energy. | Program 01 is set as SBU (SBU priority) or SUB (solar first) | Battery voltage < Setting value in Program 12                                                           | Open   | Close |
| Battery voltage > Setting value in Program 13 or battery charging reaches floating stage |                                                       |                                                              | Close                                                                                                   | Open   |       |

# OPERATION

## Power ON/OFF

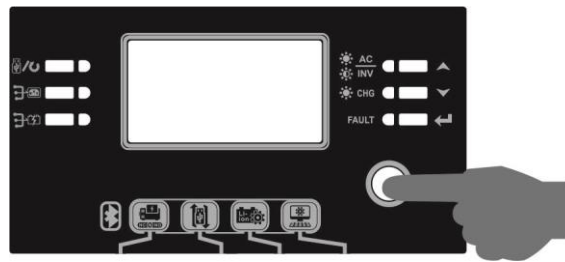

Once the unit has been properly installed and the batteries are connected well, simply press On/Off switch (located on the button of the case) to turn on the unit.

## Operation and Display Panel



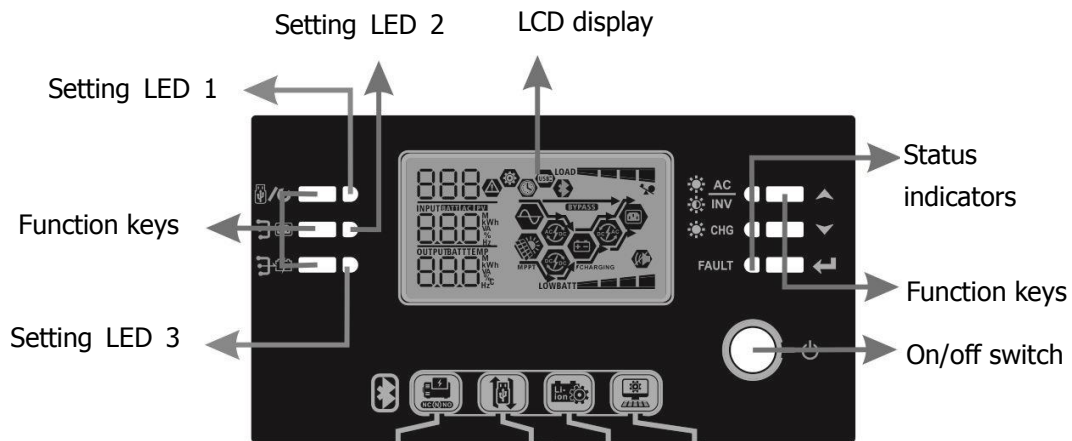

The operation and display panel, shown in below chart, is on the front panel of the inverter. It includes three indicators, four function keys and a LCD display, indicating the operating status and input/output power information.



### LED Indicators







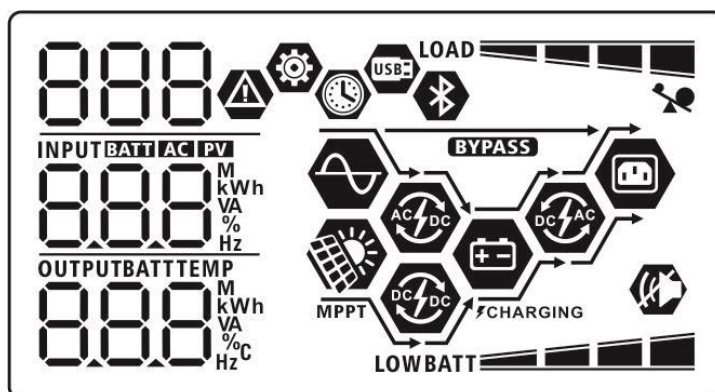

| LED Indicator           |       |                | Messages                                            |
|-------------------------|-------|----------------|-----------------------------------------------------|
| <b>Setting LED1</b>     | Green | Solid On       | Output powered by utility                           |
| <b>Setting LED2</b>     | Green | Solid On       | Output powered by PV                                |
| <b>Setting LED3</b>     | Green | Solid On       | Output powered by battery                           |
| <b>Status Indicator</b> |       | Green Solid On | Output is available in bypass mode                  |
|                         |       | Green Flashing | Output is powered by battery or AC in inverter mode |
|                         |       | Green Solid On | Battery is fully charged                            |
|                         |       | Green Flashing | Battery is charging.                                |
| <b>FAULT</b>            | Red   | Solid On       | Fault mode                                          |
|                         |       | Flashing       | Warning mode                                        |

## Function Keys

| Function Key                                                                      | Description                                                             |
|-----------------------------------------------------------------------------------|-------------------------------------------------------------------------|
|  | ESC<br>Exit setting mode                                                |
|                                                                                   | <b>USB function setting</b> <b>Select USB OTG functions</b>             |
|  | Up<br>To last selection                                                 |
|  | Down<br>To next selection                                               |
|  | Enter<br>To confirm the selection in setting mode or enter setting mode |

## LCD Display Icons



| Icon                                                                                | Function description                                                                                                                                                                                                                                                                      |                                                                        |
|-------------------------------------------------------------------------------------|-------------------------------------------------------------------------------------------------------------------------------------------------------------------------------------------------------------------------------------------------------------------------------------------|------------------------------------------------------------------------|
| <b>Input Source Information</b>                                                     |                                                                                                                                                                                                                                                                                           |                                                                        |
|  | Indicates the AC input.                                                                                                                                                                                                                                                                   |                                                                        |
|  | Indicates the PV input                                                                                                                                                                                                                                                                    |                                                                        |
|  | Indicate input voltage, input frequency, PV voltage, charger current, charger power, battery voltage.                                                                                                                                                                                     |                                                                        |
| <b>Configuration Program and Fault Information</b>                                  |                                                                                                                                                                                                                                                                                           |                                                                        |
|  | Indicates the setting programs.                                                                                                                                                                                                                                                           |                                                                        |
|  | Indicates the warning and fault codes.<br>Warning:  flashing with warning code.<br>Fault:  lighting with fault code |                                                                        |
| <b>Output Information</b>                                                           |                                                                                                                                                                                                                                                                                           |                                                                        |
|  | Indicate output voltage, output frequency, load percent, load in VA, load in Watt and discharging current.                                                                                                                                                                                |                                                                        |
| <b>Battery Information</b>                                                          |                                                                                                                                                                                                                                                                                           |                                                                        |
|  | Indicates battery level by 0-24%, 25-49%, 50-74% and 75-100% in battery mode and charging status in line mode.                                                                                                                                                                            |                                                                        |
| In AC mode, it will present battery charging status.                                |                                                                                                                                                                                                                                                                                           |                                                                        |
| Status                                                                              | Battery voltage                                                                                                                                                                                                                                                                           | LCD Display                                                            |
| Constant Current mode / Constant                                                    | <2V/cell                                                                                                                                                                                                                                                                                  | 4 bars will flash in turns.                                            |
|                                                                                     | 2 ~ 2.083V/cell                                                                                                                                                                                                                                                                           | Bottom bar will be on and the other three bars will flash in turns.    |
|                                                                                     | 2.083 ~ 2.167V/cell                                                                                                                                                                                                                                                                       | Bottom two bars will be on and the other two bars will flash in turns. |





|                                                    |                                                                |                                                          |
|----------------------------------------------------|----------------------------------------------------------------|----------------------------------------------------------|
| Voltage mode                                       | > 2.167 V/cell                                                 | Bottom three bars will be on and the top bar will flash. |
| Floating mode. Batteries are fully charged.        |                                                                | 4 bars will be on.                                       |
| In battery mode, it will present battery capacity. |                                                                |                                                          |
| Load Percentage                                    | Battery Voltage                                                | LCD Display                                              |
| Load >50%                                          | < 1.85V/cell                                                   | <b>LOW BATT</b>                                          |
|                                                    | 1.85V/cell ~ 1.933V/cell                                       | <b>BATT</b>                                              |
|                                                    | 1.933V/cell ~ 2.017V/cell                                      | <b>BATT</b>                                              |
|                                                    | > 2.017V/cell                                                  | <b>BATT</b>                                              |
| Load < 50%                                         | < 1.892V/cell                                                  | <b>LOW BATT</b>                                          |
|                                                    | 1.892V/cell ~ 1.975V/cell                                      | <b>BATT</b>                                              |
|                                                    | 1.975V/cell ~ 2.058V/cell                                      | <b>BATT</b>                                              |
|                                                    | > 2.058V/cell                                                  | <b>BATT</b>                                              |
| <b>Load Information</b>                            |                                                                |                                                          |
|                                                    | Indicates overload.                                            |                                                          |
| <br>                                               | Indicates the load level by 0-24%, 25-49%, 50-74% and 75-100%. |                                                          |
|                                                    | 0%~24%                                                         | 25%~49%                                                  |
|                                                    | <b>LOAD</b>                                                    | <b>LOAD</b>                                              |
|                                                    | 50%~74%                                                        | 75%~100%                                                 |
| <b>LOAD</b>                                        | <b>LOAD</b>                                                    |                                                          |
| <b>Mode Operation Information</b>                  |                                                                |                                                          |
|                                                    | Indicates unit connects to the mains.                          |                                                          |
|                                                    | Indicates unit connects to the PV panel.                       |                                                          |
| <b>BYPASS</b>                                      | Indicates load is supplied by utility power.                   |                                                          |
|                                                    | Indicates the utility charger circuit is working.              |                                                          |
|                                                    | Indicates the solar charger circuit is working.                |                                                          |
|                                                    | Indicates the DC/AC inverter circuit is working.               |                                                          |
|                                                    | Indicates unit alarm is disabled.                              |                                                          |
|                                                    | Indicates Bluetooth is connected.                              |                                                          |
|                                                    | Time display page                                              |                                                          |















## LCD Setting













After pressing and holding "←" button for 3 seconds, the unit will enter setting mode. Press "▲" or "▼" button to select setting programs. And then, press "←" button to confirm the selection or "⏏/↺" button to exit.









### Setting Programs:











| Program | Description                                                        | Selectable option                                                                                                                                                                                                                                                                                                                                                                                                                                                                                         |
|---------|--------------------------------------------------------------------|-----------------------------------------------------------------------------------------------------------------------------------------------------------------------------------------------------------------------------------------------------------------------------------------------------------------------------------------------------------------------------------------------------------------------------------------------------------------------------------------------------------|
| 00      | Exit setting mode                                                  | Escape<br>00 <br><br>ESC                                                                                                                                                                                                                                                                                                                                                                                                 |
| 01      | Output source priority:<br>To configure load power source priority | USB : Utility first (default)<br>01 <br><br>USB<br>Utility will provide power to the loads as first priority.<br>If Utility energy is unavailable, solar energy and battery provides power the loads.                                                                                                                                                                                                                    |
|         |                                                                    | SUB: Solar first<br>01 <br><br>SUB<br>Solar energy provides power to the loads as first priority.<br>If solar energy is not sufficient to power all connected loads, utility energy will supply power to the loads at the same time.<br>Battery provides power to the loads only when solar and utility is not sufficient.                                                                                             |
|         |                                                                    | SBU priority<br>01 <br><br>SBU<br>Solar energy provides power to the loads as first priority.<br>If solar energy is not sufficient to power all connected loads, battery energy will supply power to the loads at the same time.<br>Utility provides power to the loads only when battery voltage drops to either low-level warning voltage or the setting point in program 12 or solar and battery is not sufficient. |





















|    |                                                                                                                                                                                 |                                                                                                                                  |                                                                                                                                                                                                 |
|----|---------------------------------------------------------------------------------------------------------------------------------------------------------------------------------|----------------------------------------------------------------------------------------------------------------------------------|-------------------------------------------------------------------------------------------------------------------------------------------------------------------------------------------------|
| 02 | Maximum charging current:<br>To configure total charging current for solar and utility chargers.<br>(Max. charging current = utility charging current + solar charging current) | 60A (default)<br>02 <br><br>60 <sup>A</sup>     | 3KW model setting range is from 10A to 120A and increment of each click is 10A.<br>5KW model setting range is from 10A to 140A and increment of each click is 10A.                              |
| 05 | Battery type                                                                                                                                                                    | AGM (default)<br>05 <br><br>AGM                 | Flooded<br>05 <br><br>FLD                                                                                    |
|    |                                                                                                                                                                                 | User-Defined<br>05 <br><br>USE                  | If "User-Defined" is selected, battery charge voltage and low DC cut-off voltage can be set up in program 26, 27 and 29.                                                                        |
| 06 | Auto restart when overload occurs                                                                                                                                               | Restart disable (default)<br>06 <br><br>LFD     | Restart enable<br>06 <br><br>LFE                                                                             |
| 07 | Auto restart when over temperature occurs                                                                                                                                       | Restart disable (default)<br>07 <br><br>tFd   | Restart enable<br>07 <br><br>tFE                                                                           |
| 09 | Output frequency                                                                                                                                                                | 50Hz (default)<br>09 <br><br>50 <sub>Hz</sub> | 60Hz<br>09 <br><br>60 <sub>Hz</sub>                                                                        |
| 10 | Operation Logic                                                                                                                                                                 | Automatically (default)<br>10 <br><br>AUT     | If selected and utility is available, inverter will work in line mode. Once utility frequency is unstable, inverter will work in bypass mode if bypass function is not forbidden in program 23. |
|    |                                                                                                                                                                                 | Online mode<br>10 <br><br>ONL                 | If selected, inverter will work in line mode when utility is available.                                                                                                                         |

|    |                                                                                                                                                                                                   |                                                                                                                                                                            |                                                                                                                                                                |
|----|---------------------------------------------------------------------------------------------------------------------------------------------------------------------------------------------------|----------------------------------------------------------------------------------------------------------------------------------------------------------------------------|----------------------------------------------------------------------------------------------------------------------------------------------------------------|
|    |                                                                                                                                                                                                   | ECO Mode<br>10 <br><br>ECO                                                                | If selected and bypass is not forbidden in program 23, inverter will work in ECO mode when utility is available.                                               |
| 11 | Maximum utility charging current<br><br>Note: If setting value in program 02 is smaller than that in program in 11, the inverter will apply charging current from program 02 for utility charger. | 2A<br>11 <br><br>2 <sup>A</sup>                                                           | 10A<br>11 <br><br>10 <sup>A</sup>                                           |
|    |                                                                                                                                                                                                   | 20A<br>11 <br><br>20 <sup>A</sup>                                                         | 30A (default)<br>11 <br><br>30 <sup>A</sup>                                 |
|    |                                                                                                                                                                                                   | 40A<br>11 <br><br>40 <sup>A</sup>                                                         | 50A<br>11 <br><br>50 <sup>A</sup>                                           |
|    |                                                                                                                                                                                                   | 60A<br>11 <br><br>60 <sup>A</sup>                                                       |                                                                                                                                                                |
| 12 | Setting voltage point back to utility source when selecting "SBU" (SBU priority) or "SUB" (Solar first) in program 01                                                                             | 3KW default setting: 23.0V<br>12 <br><br>230 <sup>BATT</sup> <sub>v</sub>               | 5KW default setting: 46.0V<br>12 <br><br>460 <sup>BATT</sup> <sub>v</sub> |
|    |                                                                                                                                                                                                   | 3KW model setting range is from 22.0V to 28.5V and increment of each click is 0.5V.<br>5KW model setting range is from 44.0V to 57.0V and increment of each click is 1.0V. |                                                                                                                                                                |
| 13 | Setting voltage point back to battery mode when selecting "SBU" (SBU priority) or "SUB" (Solar first) in program 01                                                                               | 3KW model: The setting range is from 24.0V to 32.0V and increment of each click is 0.5V.                                                                                   |                                                                                                                                                                |
|    |                                                                                                                                                                                                   | Battery fully charged<br>13 <br><br>FUL <sup>BATT</sup>                                 | 27.0V (default)<br>13 <br><br>270 <sup>BATT</sup> <sub>v</sub>            |

|    |                                                                                                                     |                                                                                                                                                                                             |                                                                                                                                           |
|----|---------------------------------------------------------------------------------------------------------------------|---------------------------------------------------------------------------------------------------------------------------------------------------------------------------------------------|-------------------------------------------------------------------------------------------------------------------------------------------|
| 13 | Setting voltage point back to battery mode when selecting "SBU" (SBU priority) or "SUB" (Solar first) in program 01 | 5KW model: The setting range is from 48.0V to 64.0V and increment of each click is 1.0V.                                                                                                    |                                                                                                                                           |
|    |                                                                                                                     | Battery fully charged<br>13 <br><br>BATT<br>FUL                                                            | 54.0V (default)<br>13 <br><br>BATT<br>540 <sub>v</sub> |
| 16 | Solar energy priority:<br>To configure solar energy priority for battery and load                                   | SbL: Solar energy for battery first<br>UCB: Allow utility to charge battery (Default)<br>16 <br>SbL<br>UCb | Solar energy charges battery first and allow the utility to charge battery.                                                               |
|    |                                                                                                                     | SbL: Solar energy for battery first<br>UdC: Disallow utility to charge battery<br>16 <br>SbL<br>UdC      | Solar energy charge battery first and disallow the utility to charge battery.                                                             |
|    |                                                                                                                     | SLb: Solar energy for load first<br>UCb: Allow utility to charge battery<br>16 <br>SLb<br>UCb            | Solar energy provides power to the load first and also allow the utility to charge battery.                                               |
|    |                                                                                                                     | SLb: Solar energy for load first<br>UdC: Disallow utility to charge battery<br>16 <br>SLb<br>UdC         | Solar energy provides power to the load first and disallow the utility to charge battery.                                                 |
| 18 | Alarm control                                                                                                       | Alarm on (default)<br>18 <br><br>60n                                                                     | Alarm off<br>18 <br><br>60f                          |

|    |                                       |                                                                                                                                           |                                                                                                                                                                                         |
|----|---------------------------------------|-------------------------------------------------------------------------------------------------------------------------------------------|-----------------------------------------------------------------------------------------------------------------------------------------------------------------------------------------|
| 19 | Auto return to default display screen | Return to default display screen (default)<br>19 <br>ESP | If selected, no matter how users switch display screen, it will automatically return to default display screen (Input voltage /output voltage) after no button is pressed for 1 minute. |
|    |                                       | Stay at latest screen<br>19 <br>HEP                      | If selected, the display screen will stay at latest screen user finally switches.                                                                                                       |
| 20 | Backlight control                     | Backlight on (default)<br>20 <br>LON                     | Backlight off<br>20 <br>LOF                                                                          |
|    |                                       | Alarm on (default)<br>22 <br>AON                         | Alarm off<br>22 <br>AOF                                                                              |
| 23 | Bypass function:                      | Bypass Forbidden<br>23 <br>BYF                         | If selected, inverter won't work in bypass/ECO modes.                                                                                                                                   |
|    |                                       | Bypass disable<br>23 <br>BYD                           | If selected and power ON button is pressed on, inverter can work in bypass/ECO mode only if utility is available.                                                                       |
|    |                                       | Bypass enable (default)<br>23 <br>BYE                  | If selected and no matter power ON button is pressed on or not, inverter can work in bypass mode if utility is available.                                                               |
| 25 | Record Fault code                     | Record enable<br>25 <br>FEN                            | Record disable (default)<br>25 <br>FDS                                                             |



|                                                                                                                                                                                             |                                                                                                                                             |                                                                                                                                                        |                                                                                                                                                                                                                                                                                                                                                                                                                                                                                                                                                                   |
|---------------------------------------------------------------------------------------------------------------------------------------------------------------------------------------------|---------------------------------------------------------------------------------------------------------------------------------------------|--------------------------------------------------------------------------------------------------------------------------------------------------------|-------------------------------------------------------------------------------------------------------------------------------------------------------------------------------------------------------------------------------------------------------------------------------------------------------------------------------------------------------------------------------------------------------------------------------------------------------------------------------------------------------------------------------------------------------------------|
| 26                                                                                                                                                                                          | Bulk charging voltage<br>(C.V voltage)                                                                                                      | 3KW default setting: 28.2V<br>26 <br>CU<br>BATT<br>28.2 <sub>v</sub>  | 5KW default setting: 56.4V<br>26 <br>CU<br>BATT<br>56.4 <sub>v</sub>                                                                                                                                                                                                                                                                                                                                                                                                           |
| If self-defined is selected in program 5, this program can be set up. Setting range is from 24.0V to 32.0V for 3KW model and 48.0V to 64.0V for 5KW model. Increment of each click is 0.1V. |                                                                                                                                             |                                                                                                                                                        |                                                                                                                                                                                                                                                                                                                                                                                                                                                                                                                                                                   |
| 27                                                                                                                                                                                          | Floating charging voltage                                                                                                                   | 3KW default setting: 27.0V<br>27 <br>FLU<br>BATT<br>27.0 <sub>v</sub> | 5KW default setting: 54.0V<br>27 <br>FLU<br>BATT<br>54.0 <sub>v</sub>                                                                                                                                                                                                                                                                                                                                                                                                          |
| If self-defined is selected in program 5, this program can be set up. Setting range is from 24.0V to 32.0V for 3KW model and 48.0V to 64.0V for 5KW model. Increment of each click is 0.1V. |                                                                                                                                             |                                                                                                                                                        |                                                                                                                                                                                                                                                                                                                                                                                                                                                                                                                                                                   |
| 28                                                                                                                                                                                          | AC output mode<br>*This setting is able to set up only when the inverter is in standby mode, Be sure that on/off Switch is in "OFF" status. | Single<br>28 <br>SIG                                                  | When the unit is operated alone, please select "SIG" in program 28.                                                                                                                                                                                                                                                                                                                                                                                                                                                                                               |
|                                                                                                                                                                                             |                                                                                                                                             | Parallel<br>28 <br>PAR                                              | When the units are used in parallel for single phase application, please select "PAL" in program 28. Please refer to 5-1 for detailed information.                                                                                                                                                                                                                                                                                                                                                                                                                |
|                                                                                                                                                                                             |                                                                                                                                             | L1 phase<br>28 <br>3P1                                              | When the units are operated in 3-phase application, please choose "3PX" to define each inverter. It is required to have at least 3 inverters or maximum 9 inverters to support three-phase equipment. It's required to have at least one inverter in each phase or it's up to four inverters in one phase. Please refers to 5-2 for detailed information. Please select "3P1" in program 28 for the inverters connected to L1 phase, "3P2" in program 28 for the inverters connected to L2 phase and "3P3" in program 28 for the inverters connected to L3 phase. |
|                                                                                                                                                                                             |                                                                                                                                             | L2 phase<br>28 <br>3P2                                              |                                                                                                                                                                                                                                                                                                                                                                                                                                                                                                                                                                   |
|                                                                                                                                                                                             |                                                                                                                                             | L3 phase<br>28 <br>3P3                                              | Be sure to connect share current cable to units which are on the same phase.<br>Do NOT connect share current cable between units on different phases.                                                                                                                                                                                                                                                                                                                                                                                                             |





|    |                              |                                                                                                                                                                                                                                                                                                   |                                                                                                                                 |
|----|------------------------------|---------------------------------------------------------------------------------------------------------------------------------------------------------------------------------------------------------------------------------------------------------------------------------------------------|---------------------------------------------------------------------------------------------------------------------------------|
| 29 | Low DC cut-off voltage       | 3KW default setting: 21.0V<br>                                                                                                                                                                                   | 5KW default setting: 42.0V<br>               |
|    |                              | If self-defined is selected in program 5, this program can be set up. Setting range is from 20.0V to 27.0V for 3KW model and 40.0V to 54.0V for 5KW model. Increment of each click is 0.1V. Low DC cut-off voltage will be fixed to setting value no matter what percentage of load is connected. |                                                                                                                                 |
| 32 | Bulk charging time           | auto-charging time (default)<br>                                                                                                                                                                                 | 5min<br>                                     |
|    |                              | If "User-Defined" is selected in program 05, this program can be set up. Setting range is from 5min to 900min. Increment of each click is 5min. Otherwise, Keeping auto-charging time.                                                                                                            |                                                                                                                                 |
| 33 | Battery equalization         | Battery equalization enable<br>                                                                                                                                                                                | Battery equalization disable (default)<br> |
|    |                              | If "Flooded" or "User-Defined" is selected in program 05, this program can be set up.                                                                                                                                                                                                             |                                                                                                                                 |
| 34 | Battery equalization voltage | 3KW default setting: 29.2V<br>                                                                                                                                                                                 | 5KW default setting: 58.4V<br>             |
|    |                              | Setting range is from 24.0V to 32.0V for 3KW model and 48.0V to 64.0V for 5KW model. Increment of each click is 0.1V.                                                                                                                                                                             |                                                                                                                                 |
| 35 | Battery equalized time       | 60min (default)<br>                                                                                                                                                                                            | Setting range is from 5min to 900min. Increment of each click is 5min.                                                          |

|    |                                    |                                                                                                                                                                                                                                                                                                                                                                                                                |                                                                          |
|----|------------------------------------|----------------------------------------------------------------------------------------------------------------------------------------------------------------------------------------------------------------------------------------------------------------------------------------------------------------------------------------------------------------------------------------------------------------|--------------------------------------------------------------------------|
| 36 | Battery equalized timeout          | 120min (default)<br>36 ⚙️<br><br>120                                                                                                                                                                                                                                                                                                                                                                           | Setting range is from 5min to 900 min. Increment of each click is 5 min. |
| 37 | Equalization interval              | 30days (default)<br>37 ⚙️<br><br>30d                                                                                                                                                                                                                                                                                                                                                                           | Setting range is from 0 to 90 days. Increment of each click is 1 day     |
| 39 | Equalization activated immediately | Disable (default)<br>39 ⚙️<br><br>AdS                                                                                                                                                                                                                                                                                                                                                                          | Enable<br>39 ⚙️<br><br>AEN                                               |
|    |                                    | If equalization function is enabled in program 33, this program can be set up. If "Enable" is selected in this program, it's to activate battery equalization immediately and LCD main page will shows "E9". If "Disable" is selected, it will cancel equalization function until next activated equalization time arrives based on program 37 setting. At this time, "E9" will not be shown in LCD main page. |                                                                          |
| 40 | Reset PV and Load energy storage   | Not reset(Default)<br>40 ⚙️<br><br>Nrt                                                                                                                                                                                                                                                                                                                                                                         | Reset<br>40 ⚙️<br><br>rst                                                |
| 93 | Erase all data log                 | Not reset(Default)<br>93 ⚙️<br><br>Nrt                                                                                                                                                                                                                                                                                                                                                                         | Reset<br>93 ⚙️<br><br>rst                                                |
| 94 | Data log stored period             | 3 days<br>94 ⚙️<br><br>3                                                                                                                                                                                                                                                                                                                                                                                       | 5 days<br>94 ⚙️<br><br>5                                                 |
|    |                                    | 10 days (default)<br>94 ⚙️<br><br>10                                                                                                                                                                                                                                                                                                                                                                           | 20 days<br>94 ⚙️<br><br>20                                               |

|    |                       |                            |                                                 |
|----|-----------------------|----------------------------|-------------------------------------------------|
|    |                       | 30 days<br>94 ⚙️<br><br>30 | 60 days<br>94 ⚙️<br><br>60                      |
| 95 | Time setting – Minute | 95 ⚙️<br>mi n<br>00        | For minute setting, the range is from 00 to 59. |
| 96 | Time setting – Hour   | 96 ⚙️<br>HOU<br>00         | For hour setting, the range is from 00 to 23.   |
| 97 | Time setting– Day     | 97 ⚙️<br>day<br>01         | For day setting, the range is from 00 to 31.    |
| 98 | Time setting– Month   | 98 ⚙️<br>mon<br>01         | For month setting, the range is from 01 to 12.  |
| 99 | Time setting – Year   | 99 ⚙️<br>YEA<br>17         | For year setting, the range is from 17 to 99.   |

























## USB Function Setting

Please insert USB disk into USB port () . Press and hold “/” button for 3 seconds to enter USB function setting mode. These functions include to upgrade inverter firmware, export data log and re-write internal parameters from USB disk.

| Procedure                                                                                                                                                                                                                                                                                                                                          | LCD Screen                                                                                   |
|----------------------------------------------------------------------------------------------------------------------------------------------------------------------------------------------------------------------------------------------------------------------------------------------------------------------------------------------------|----------------------------------------------------------------------------------------------|
| <b>Step 1:</b> Press and hold “  /” button for 3 seconds to enter USB function setting mode.                                                                                                                                                                    | UPG ⚙️  |
| <b>Step 2:</b> Press “  /”, “  ” or “  ” button to enter the selectable setting programs. | SET<br>LOG                                                                                   |



**Step 3:** Please select setting program by following each procedure.

| Program#                                                                                                                                                                        | Operation Procedure                                                                                                                                                                                                                                                                                                                                              | LCD Screen                                                                            |
|---------------------------------------------------------------------------------------------------------------------------------------------------------------------------------|------------------------------------------------------------------------------------------------------------------------------------------------------------------------------------------------------------------------------------------------------------------------------------------------------------------------------------------------------------------|---------------------------------------------------------------------------------------|
| <br>Upgrade firmware                                                                           | If pressing "  " button to proceed the firmware upgrade function. If the selected function is ready, LCD will display "Fdy". Please press "  " button to confirm the selection again.          |    |
|                                                                                                                                                                                 | Press "  " to select "Yes" or "  " button to select "No". Then, press "  " button to exit setting mode.       |    |
| <br>Re-write internal parameters                                                               | If pressing "  " button to proceed parameters re-write from USB function. If selected function is ready, LCD will display "Fdy". Please press "  " button to confirm the selection again.      |    |
|                                                                                                                                                                                 | Press "  " to select "Yes" or "  " button to select "No". Then, press "  " button to exit setting mode.       |    |
| <p><b>IMPORTANT NOTE:</b> After this function is executed, partial LCD setting programs will be locked. For the detailed information, please check your installer directly.</p> |                                                                                                                                                                                                                                                                                                                                                                  |                                                                                       |
| <br>Export data log                                                                          | If pressing "  " button to export data log from USB disk to the inverter. If selected function is ready, LCD will display "Fdy". Please press "  " button to confirm the selection again.    |   |
|                                                                                                                                                                                 | Press "  " to select "Yes" or "  " button to select "No". Then, press "  " button to exit setting mode. |  |

If no button is pressed for 1 minute, it will automatically return to main screen.

**Error message for USB On-the-Go functions:**

| Error Code | Messages                                        |
|------------|-------------------------------------------------|
| U01        | No USB disk is detected.                        |
| U02        | USB disk is protected from copy.                |
| U03        | Document inside the USB disk with wrong format. |

If any error occurs, error code will only show 5 seconds. After 5 seconds, it will automatically return to display screen.

## Display Setting

The LCD display information will be switched in turns by pressing "▲" or "▼" button. The selectable information is switched as below order: input voltage, input frequency, PV voltage, charging current, charging power, battery voltage, output voltage, output frequency, load percentage, load in Watt, load in VA, load in Watt, DC discharging current, main CPU Version.

| Selectable information                                   | LCD display                                    |
|----------------------------------------------------------|------------------------------------------------|
| Input voltage/Output voltage<br>(Default Display Screen) | <p>Input Voltage=230V, output voltage=230V</p> |
| Input frequency                                          | <p>Input frequency=50Hz</p>                    |
| PV voltage                                               | <p>PV voltage=80V</p>                          |
| PV current                                               | <p>PV current = 2.5A</p>                       |
| PV power                                                 | <p>PV power = 500W</p>                         |

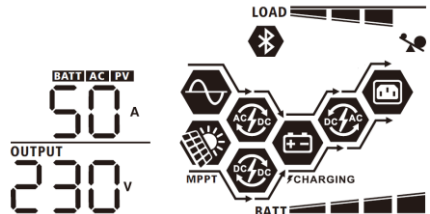
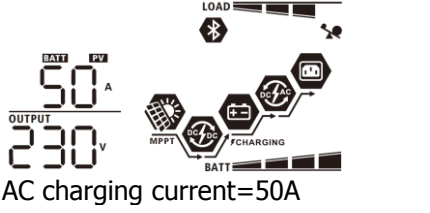
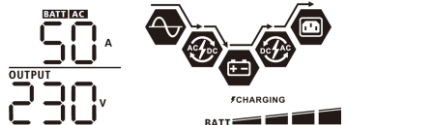
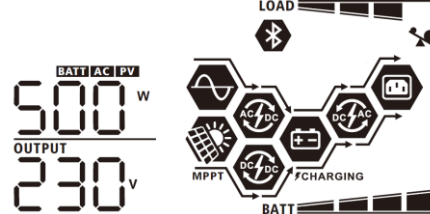
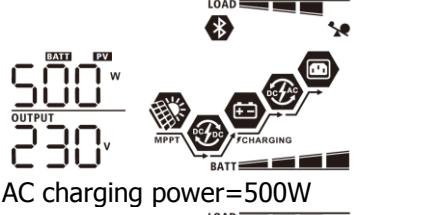
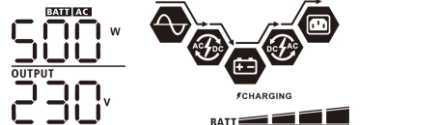
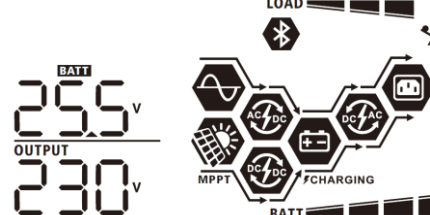
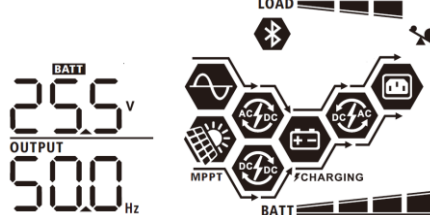

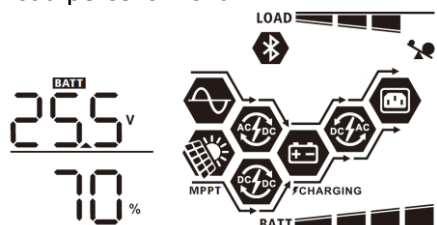
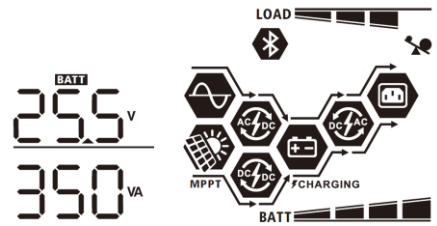
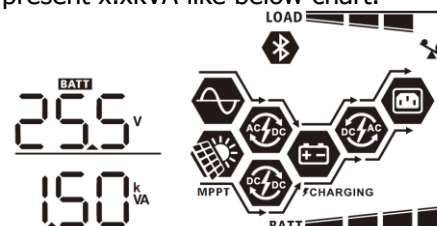
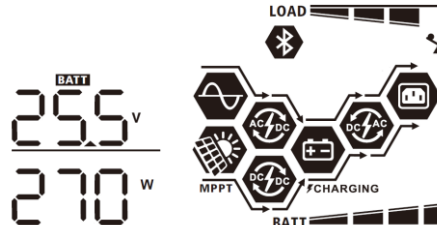
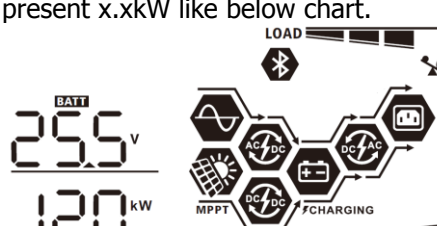
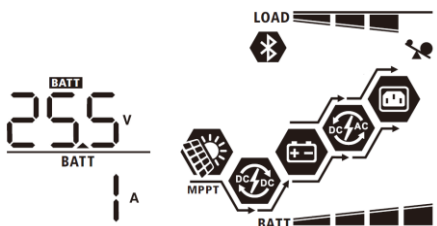

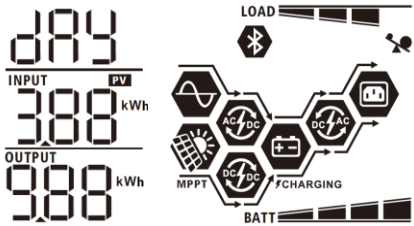
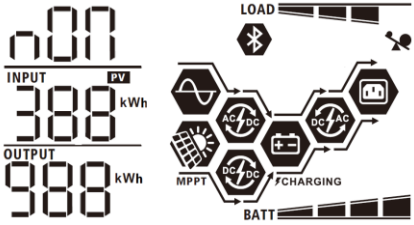
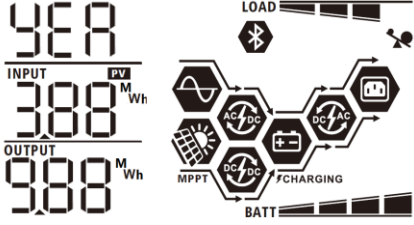
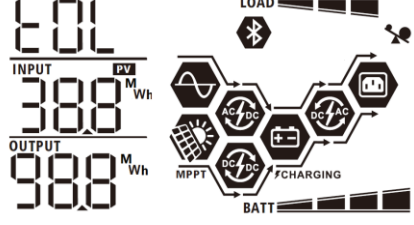
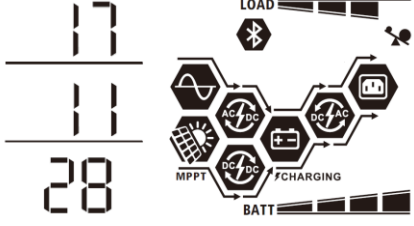
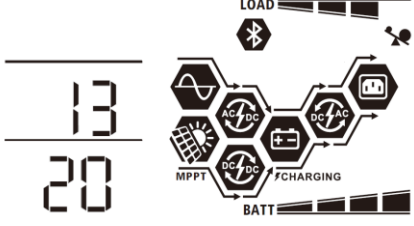

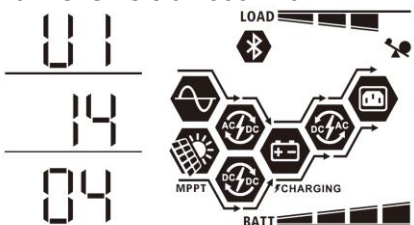
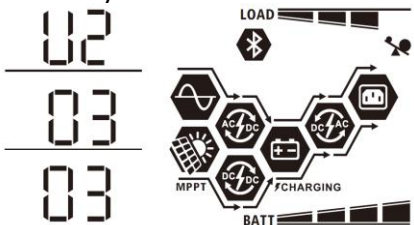
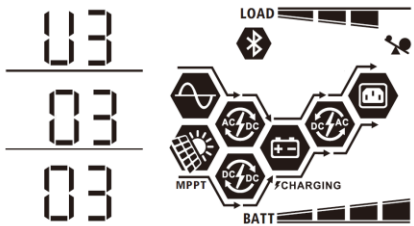
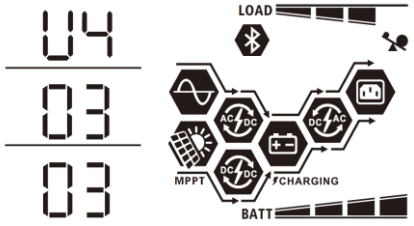
|                                           |                                                                                                                                                                                                                                                                                                                                                                |
|-------------------------------------------|----------------------------------------------------------------------------------------------------------------------------------------------------------------------------------------------------------------------------------------------------------------------------------------------------------------------------------------------------------------|
| <p>Charging current</p>                   | <p>AC and PV charging current=50A</p>  <p>PV charging current=50A</p>  <p>AC charging current=50A</p>    |
| <p>Charging power</p>                     | <p>AC and PV charging power=500W</p>  <p>PV charging power=500W</p>  <p>AC charging power=500W</p>  |
| <p>Battery voltage and output voltage</p> | <p>Battery voltage=25.5V, output voltage=230V</p>                                                                                                                                                                                                                          |
| <p>Output frequency</p>                   | <p>Output frequency=50Hz</p>                                                                                                                                                                                                                                               |



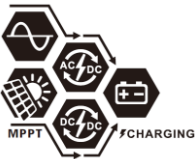

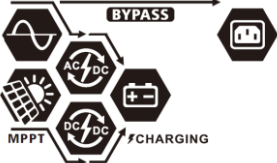
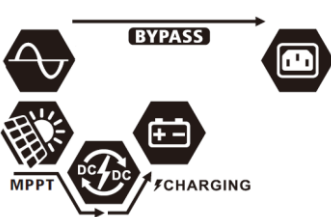

|                                               |                                                                                                                                                                                                                                                                                                                                                                                             |
|-----------------------------------------------|---------------------------------------------------------------------------------------------------------------------------------------------------------------------------------------------------------------------------------------------------------------------------------------------------------------------------------------------------------------------------------------------|
| <p>Load percentage</p>                        | <p>Load percent=70%</p>                                                                                                                                                                                                                                                                                   |
| <p>Load in VA</p>                             | <p>When connected load is lower than 1kVA, load in VA will present xxxVA like below chart.</p>  <p>When load is larger than 1kVA (<math>\geq 1\text{kVA}</math>), load in VA will present x.xkVA like below chart.</p>  |
| <p>Load in Watt</p>                           | <p>When load is lower than 1kW, load in W will present xxxW like below chart.</p>  <p>When load is larger than 1kW (<math>\geq 1\text{kW}</math>), load in W will present x.xkW like below chart.</p>               |
| <p>Battery voltage/DC discharging current</p> | <p>Battery voltage=25.5V, discharging current=1A</p>                                                                                                                                                                                                                                                    |

|                                                                          |                                                                                                                                                                                    |
|--------------------------------------------------------------------------|------------------------------------------------------------------------------------------------------------------------------------------------------------------------------------|
| <p>PV energy generated today and Load output energy today</p>            | <p>PV energy generated Today = 3.88kWh, Load output energy Today = 9.88kWh.</p>                  |
| <p>PV energy generated this month and Load output energy this month.</p> | <p>PV energy generated this month = 388kWh, Load output energy this month = 988kWh.</p>          |
| <p>PV energy generated this year and Load output energy this year.</p>   | <p>PV energy generated this year energy = 3.88MWh, Load output energy this year = 9.88MWh.</p>  |
| <p>PV energy generated totally and Load output total energy.</p>         | <p>Total PV energy until now= 38.8MWh, Total load output energy until now= 98.8MWh.</p>        |
| <p>Real date.</p>                                                        | <p>Real date Nov 28, 2017.</p>                                                                 |
| <p>Real time.</p>                                                        | <p>Real time 13:20.</p>                                                                        |

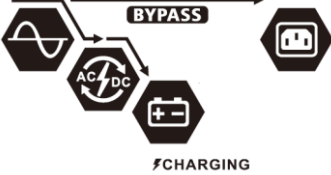
|                                        |                                                                                                                                                                                                                                                                                                  |
|----------------------------------------|--------------------------------------------------------------------------------------------------------------------------------------------------------------------------------------------------------------------------------------------------------------------------------------------------|
| <p>Main CPU version checking.</p>      | <p>Main CPU version 00014.04.</p>  <p>The display shows the version number 01.14.04. To the right is a system status diagram with icons for LOAD, Bluetooth, MPPT, AC/DC, DC/AC, FCHARGING, and BATT.</p>      |
| <p>Secondary CPU version checking.</p> | <p>Secondary CPU version 00003.03.</p>  <p>The display shows the version number 02.03.03. To the right is a system status diagram with icons for LOAD, Bluetooth, MPPT, AC/DC, DC/AC, FCHARGING, and BATT.</p> |
| <p>Bluetooth version checking.</p>     | <p>Bluetooth version 00003.03.</p>  <p>The display shows the version number 03.03.03. To the right is a system status diagram with icons for LOAD, Bluetooth, MPPT, AC/DC, DC/AC, FCHARGING, and BATT.</p>     |
| <p>SCC version checking</p>            | <p>SCC version 00003.03.</p>  <p>The display shows the version number 04.03.03. To the right is a system status diagram with icons for LOAD, Bluetooth, MPPT, AC/DC, DC/AC, FCHARGING, and BATT.</p>          |

# Operating Mode Description

| Operation mode                                                                                                                                                               | Description                                                                                             | LCD display                                                                                                                    |
|------------------------------------------------------------------------------------------------------------------------------------------------------------------------------|---------------------------------------------------------------------------------------------------------|--------------------------------------------------------------------------------------------------------------------------------|
| <p>Standby mode</p> <p><b>Note:</b></p> <p>*Standby mode: The inverter is not turned on yet but at this time, the inverter can charge battery without AC output.</p>         | <p>No output is supplied by the unit but it still can charge batteries.</p>                             | <p>Charging by utility and PV energy.</p>    |
|                                                                                                                                                                              |                                                                                                         | <p>Charging by utility.</p>                  |
|                                                                                                                                                                              |                                                                                                         | <p>Charging by PV energy.</p>                |
|                                                                                                                                                                              |                                                                                                         | <p>No charging.</p>                           |
| <p>Fault mode</p> <p>Note:</p> <p>*Fault mode: Errors are caused by inside circuit error or external reasons such as over temperature, output short circuited and so on.</p> | <p>Utility can bypass.</p>                                                                              | <p>No charging and Bypass</p>              |
|                                                                                                                                                                              |                                                                                                         | <p>No charging</p>                          |
| <p>Bypass/ECO Mode</p>                                                                                                                                                       | <p>The unit will provide output power from the utility. PV energy and utility can charge batteries.</p> | <p>Charging by utility and PV energy.</p>  |
|                                                                                                                                                                              |                                                                                                         | <p>Charging by PV</p>                      |











|                        |                                                                                                         |                                                                                                                                                                           |
|------------------------|---------------------------------------------------------------------------------------------------------|---------------------------------------------------------------------------------------------------------------------------------------------------------------------------|
| <p>Bypass/ECO Mode</p> | <p>The unit will provide output power from the utility. PV energy and utility can charge batteries.</p> | <p>Charging by utility</p>                                                              |
| <p>Line Mode</p>       | <p>The unit will provide output power from the mains. It will also charge the battery at line mode.</p> | <p>No charging</p>                                                                      |
| <p>Battery Mode</p>    | <p>The unit will provide output power from battery and PV power.</p>                                    | <p>Charging by utility and PV energy.</p>                                               |
| <p>Battery Mode</p>    | <p>The unit will provide output power from battery and PV power.</p>                                    | <p>Charging by utility.</p>                                                            |
| <p>Battery Mode</p>    | <p>The unit will provide output power from battery and PV power.</p>                                    | <p>Power from battery and PV energy.</p>                                              |
| <p>Battery Mode</p>    | <p>The unit will provide output power from battery and PV power.</p>                                    | <p>PV energy will supply power to the loads and charge battery at the same time.</p>  |
| <p>Battery Mode</p>    | <p>The unit will provide output power from battery and PV power.</p>                                    | <p>Power from battery only.</p>                                                       |



## Fault Reference Code

| Fault Code | Fault Event                                                                              | Icon on |
|------------|------------------------------------------------------------------------------------------|---------|
| 01         | Fan is locked when inverter is off.                                                      | F01     |
| 02         | Over temperature                                                                         | F02     |
| 03         | Battery voltage is too high                                                              | F03     |
| 04         | Battery voltage is too low                                                               | F04     |
| 05         | Output short circuited or over temperature is detected by internal converter components. | F05     |
| 06         | Output voltage is too high.                                                              | F06     |
| 07         | Overload time out                                                                        | F07     |
| 08         | Bus voltage is too high                                                                  | F08     |
| 09         | Bus soft start failed                                                                    | F09     |
| 50         | PFC over current                                                                         | F50     |
| 51         | OP over current                                                                          | F51     |
| 52         | Bus voltage is too low                                                                   | F52     |
| 53         | Inverter soft start failed                                                               | F53     |
| 55         | Over DC voltage in AC output                                                             | F55     |
| 56         | Battery is not connected                                                                 | F56     |
| 57         | Current sensor failed                                                                    | F57     |
| 58         | Output voltage is too low                                                                | F58     |

## Warning Indicator

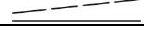
| Warning Code | Warning Event                      | Audible Alarm                 | Icon flashing                                                                                                                                                                  |
|--------------|------------------------------------|-------------------------------|--------------------------------------------------------------------------------------------------------------------------------------------------------------------------------|
| 01           | Fan is locked when inverter is on. | Beep three times every second | 01                                                                                        |
| 02           | Over temperature                   | None                          | 02                                                                                        |
| 03           | Battery is over-charged            | Beep once every second        | 03                                                                                        |
| 04           | Low battery                        | Beep once every second        | 04                                                                                        |
| 07           | Overload                           | Beep once every 0.5 second    | 07   |
| 10           | Output power derating              | Beep twice every 3 seconds    | 10                                                                                        |
| 32           | Communication interrupted          | None                          | 32                                                                                        |
| E9           | Battery equalization               | None                          | E9                                                                                        |
| 6P           | Battery is not connected           | None                          | 6P   |

# Battery Equalization

Equalization function is added into charge controller. It reverses the buildup of negative chemical effects like stratification, a condition where acid concentration is greater at the bottom of the battery than at the top. Equalization also helps to remove sulfate crystals that might have built up on the plates. If left unchecked, this condition, called sulfation, will reduce the overall capacity of the battery. Therefore, it's recommended to equalize battery periodically.

- **How to Apply Equalization Function**

You must enable battery equalization function in monitoring LCD setting program 33 first. Then, you may apply this function in device by either one of following methods:

1. Setting equalization interval in program 37.
2. Active equalization immediately in program 39.

- **When to Equalize**

In float stage, when the setting equalization interval (battery equalization cycle) is arrived, or equalization is active immediately, the controller will start to enter Equalize stage.

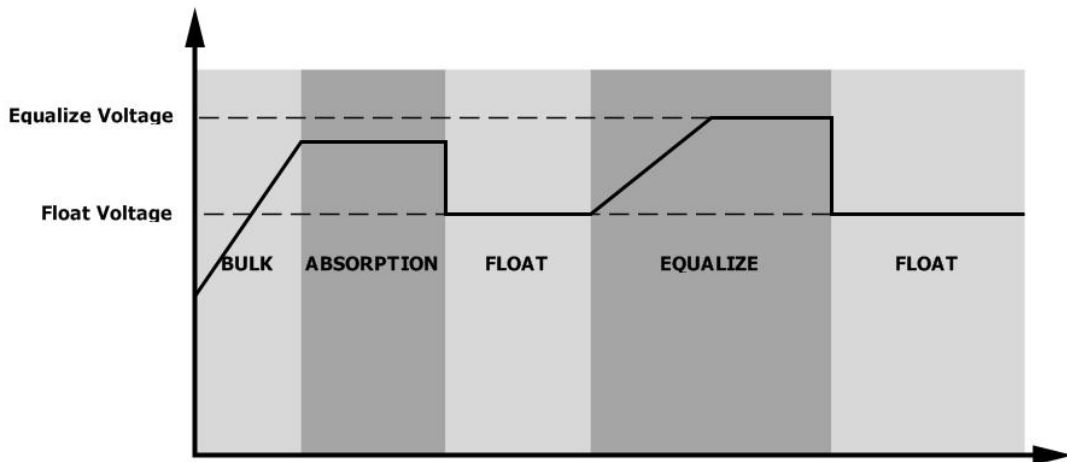

- **Equalize charging time and timeout**

In Equalize stage, the controller will supply power to charge battery as much as possible until battery voltage raises to battery equalization voltage. Then, constant-voltage regulation is applied to maintain battery voltage at the battery equalization voltage. The battery will remain in the Equalize stage until setting battery equalized time is arrived.

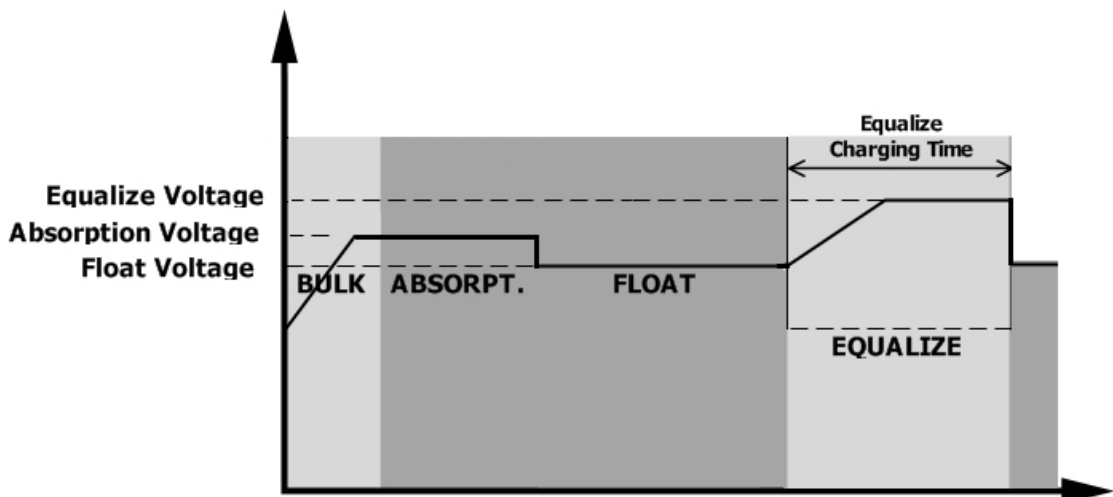

However, in Equalize stage, when battery equalized time is expired and battery voltage doesn't rise to battery equalization voltage point, the charge controller will extend the battery equalized time until battery voltage achieves battery equalization voltage. If battery voltage is still lower than battery equalization voltage when battery equalized timeout setting is over, the charge controller will stop equalization and return to float stage.

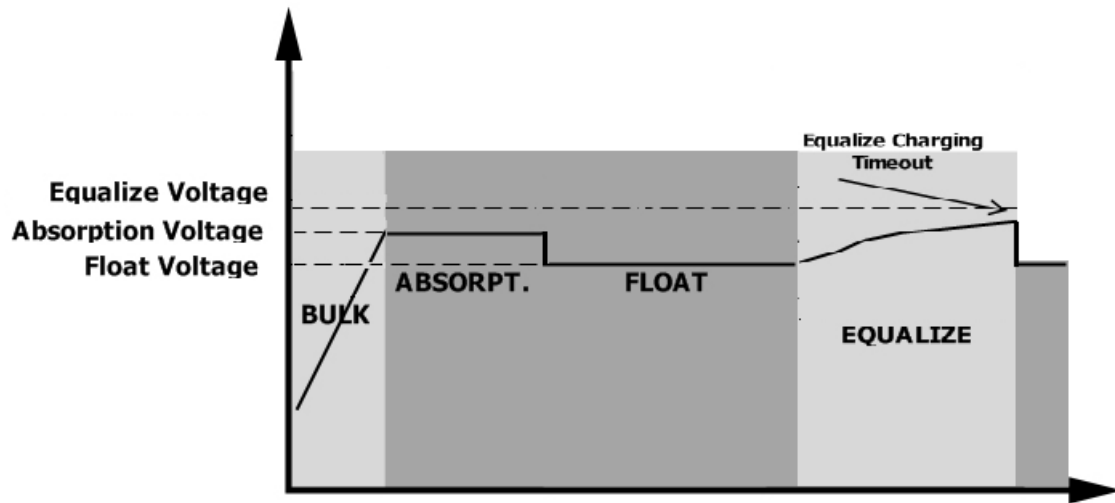

# SPECIFICATIONS

Table 1 Line Mode Specifications

| INVERTER MODEL                         | 3KW                                                             | 5KW |
|----------------------------------------|-----------------------------------------------------------------|-----|
| <b>Input Voltage Waveform</b>          | Sinusoidal                                                      |     |
| <b>Nominal Input Voltage</b>           | 230Vac                                                          |     |
| <b>Low Loss Voltage</b>                | 110Vac±7V                                                       |     |
| <b>Low Loss Return Voltage</b>         | 120Vac±7V                                                       |     |
| <b>High Loss Voltage</b>               | 280Vac±7V                                                       |     |
| <b>High Loss Return Voltage</b>        | 270Vac±7V                                                       |     |
| <b>Max AC Input Voltage</b>            | 300Vac                                                          |     |
| <b>Nominal Input Frequency</b>         | 50Hz / 60Hz (Auto detection)                                    |     |
| <b>Low Loss Frequency</b>              | 46(56)±1Hz                                                      |     |
| <b>Low Loss Return Frequency</b>       | 46.5(57)±1Hz                                                    |     |
| <b>High Loss Frequency</b>             | 54(64)±1Hz                                                      |     |
| <b>High Loss Return Frequency</b>      | 53(63)±1Hz                                                      |     |
| <b>Power Factor</b>                    | >0.98                                                           |     |
| <b>Output Short Circuit Protection</b> | Line mode: Circuit Breaker<br>Battery mode: Electronic Circuits |     |
| <b>Efficiency (Line Mode)</b>          | 93% (Peak Efficiency)                                           |     |
| <b>Transfer Time</b>                   | Line mode←→Battery mode 0ms<br>Inverter←→Bypass 4ms             |     |

Table 2 Battery Mode Specifications

| <b>INVERTER MODEL</b>                                                | <b>3KW</b>                        | <b>5KW</b>         |
|----------------------------------------------------------------------|-----------------------------------|--------------------|
| <b>Rated Output Power</b>                                            | 3KVA/3KW                          | 5KVA/5KW           |
| <b>Output Voltage Waveform</b>                                       | Pure Sine Wave                    |                    |
| <b>Output Voltage Regulation</b>                                     | 230Vac±5%                         |                    |
| <b>Output Frequency</b>                                              | 50Hz or 60Hz                      |                    |
| <b>Peak Efficiency</b>                                               | 90%                               |                    |
| <b>Overload Protection</b>                                           | 5s@≥150% load; 10s@105%~150% load |                    |
| <b>Surge Capacity</b>                                                | 2* rated power for 5 seconds      |                    |
| <b>Nominal DC Input Voltage</b>                                      | 24Vdc                             | 48Vdc              |
| <b>Operating Range</b>                                               | 20Vdc -34Vdc                      | 40Vdc -66Vdc       |
| <b>Cold Start Voltage</b>                                            | 23Vdc                             | 46Vdc              |
| <b>Low DC Warning Voltage</b><br>@ load < 50%<br>@ load ≥ 50%        | 22.5Vdc<br>22.0Vdc                | 45.0Vdc<br>44.0Vdc |
| <b>Low DC Warning Return Voltage</b><br>@ load < 50%<br>@ load ≥ 50% | 23.5Vdc<br>23.0Vdc                | 47.0Vdc<br>46.0Vdc |
| <b>Low DC Cut-off Voltage</b><br>@ load < 50%<br>@ load ≥ 50%        | 21.5Vdc<br>21.0Vdc                | 43.0Vdc<br>42.0Vdc |
| <b>High DC Recovery Voltage</b>                                      | 32Vdc                             | 64Vdc              |
| <b>High DC Cut-off Voltage</b>                                       | 34Vdc                             | 66Vdc              |
| <b>No Load Power Consumption</b>                                     | <75W                              | <75W               |

Table 3 Charge Mode Specifications

| Utility Charging Mode                       |                        |         |         |
|---------------------------------------------|------------------------|---------|---------|
| INVERTER MODEL                              | 3KW                    | 5KW     |         |
| Charging Current<br>@ Nominal Input Voltage | Default: 30A, max: 60A |         |         |
| Bulk Charging Voltage                       | Flooded Battery        | 29.2Vdc | 58.4Vdc |
|                                             | AGM / Gel Battery      | 28.2Vdc | 56.4Vdc |
| Floating Charging Voltage                   | 27Vdc                  | 54Vdc   |         |
| Overcharge Protection                       | 34Vdc                  | 66Vdc   |         |
| Charging Algorithm                          | 3-Step                 |         |         |
| Charging Curve                              |                        |         |         |

| Solar Charging Mode (MPPT type)    |            |           |
|------------------------------------|------------|-----------|
| INVERTER MODEL                     | 3KW        | 5KW       |
| Rated Power                        | 1500W      | 4000W     |
| Maximum charging current           | 60A        | 80A       |
| Efficiency                         | 98.0% max. |           |
| Max. PV Array Open Circuit Voltage | 145Vdc     |           |
| PV Array MPPT Voltage Range        | 30~115Vdc  | 60~115Vdc |
| Battery Voltage Accuracy           | +/-0.3%    |           |
| PV Voltage Accuracy                | +/-2V      |           |
| Charging Algorithm                 | 3-Step     |           |
| Joint Utility and Solar Charging   |            |           |
| Max Charging Current               | 120A       | 140A      |
| Default Charging Current           | 60A        |           |

Table 4 ECO/Bypass Mode Specifications

| <b>Bypass Mode</b>                |                              |            |
|-----------------------------------|------------------------------|------------|
| <b>INVERTER MODEL</b>             | <b>3KW</b>                   | <b>5KW</b> |
| <b>Input Voltage Waveform</b>     | Sinusoidal                   |            |
| <b>Low Loss Voltage</b>           | 176Vac±7V                    |            |
| <b>Low Loss Return Voltage</b>    | 186Vac±7V                    |            |
| <b>High Loss Voltage</b>          | 280Vac±7V                    |            |
| <b>High Loss Return Voltage</b>   | 270Vac±7V                    |            |
| <b>Nominal Input Frequency</b>    | 50Hz / 60Hz (Auto detection) |            |
| <b>Low Loss Frequency</b>         | 46(56)±1Hz                   |            |
| <b>Low Loss Return Frequency</b>  | 46.5(57)±1Hz                 |            |
| <b>High Loss Frequency</b>        | 54(64)±1Hz                   |            |
| <b>High Loss Return Frequency</b> | 53(63)±1Hz                   |            |

Table 5 General Specifications

| <b>INVERTER MODEL</b>              | <b>3KW</b>                                   | <b>5KW</b> |
|------------------------------------|----------------------------------------------|------------|
| <b>SCC type</b>                    | <b>MPPT</b>                                  |            |
| <b>Parallel-able</b>               | YES                                          |            |
| <b>Communication</b>               | RS232 and Bluetooth                          |            |
| <b>Safety Certification</b>        | CE                                           |            |
| <b>Operating Temperature Range</b> | 0°C to 55°C                                  |            |
| <b>Storage temperature</b>         | -15°C~ 60°C                                  |            |
| <b>Humidity</b>                    | 5% to 95% Relative Humidity (Non-condensing) |            |
| <b>Dimension (D*W*H), mm</b>       | 140 x 303 x 525                              |            |
| <b>Net Weight, kg</b>              | 13.0                                         | 13.5       |

# TROUBLE SHOOTING

| Problem                                                                       | LCD/LED/Buzzer                                                          | Explanation / Possible cause                                                                      | What to do                                                                                                                                                             |
|-------------------------------------------------------------------------------|-------------------------------------------------------------------------|---------------------------------------------------------------------------------------------------|------------------------------------------------------------------------------------------------------------------------------------------------------------------------|
| Unit shuts down automatically during startup process.                         | LCD/LEDs and buzzer will be active for 3 seconds and then complete off. | The battery voltage is too low (<1.91V/Cell)                                                      | 1. Re-charge battery.<br>2. Replace battery.                                                                                                                           |
| No response after power on.                                                   | No indication.                                                          | 1. The battery voltage is far too low. (<1.4V/Cell)<br>2. Battery polarity is connected reversed. | 1. Check if batteries and the wiring are connected well.<br>2. Re-charge battery.<br>3. Replace battery.                                                               |
| Mains exist but the unit works in battery mode.                               | Input voltage is displayed as 0 on the LCD and green LED is flashing.   | Input protector is tripped                                                                        | Check if AC breaker is tripped and AC wiring is connected well.                                                                                                        |
|                                                                               | Green LED is flashing.                                                  | Insufficient quality of AC power. (Shore or Generator)                                            | 1. Check if AC wires are too thin and/or too long.<br>2. Check if generator (if applied) is working well or if input voltage range setting is correct. (UPS→Appliance) |
|                                                                               | Green LED is flashing.                                                  | Set "Solar First" as the priority of output source.                                               | Change output source priority to Utility first.                                                                                                                        |
| When the unit is turned on, internal relay is switched on and off repeatedly. | LCD display and LEDs are flashing                                       | Battery is disconnected.                                                                          | Check if battery wires are connected well.                                                                                                                             |
| Buzzer beeps continuously and red LED is on.                                  | Fault code 07                                                           | Overload error. The inverter is overload 110% and time is up.                                     | Reduce the connected load by switching off some equipment.                                                                                                             |
|                                                                               | Fault code 05                                                           | Output short circuited.                                                                           | Check if wiring is connected well and remove abnormal load.                                                                                                            |
|                                                                               | Fault code 02                                                           | Internal temperature of inverter component is over 100°C.                                         | Check whether the air flow of the unit is blocked or whether the ambient temperature is too high.                                                                      |
|                                                                               | Fault code 03                                                           | Battery is over-charged.                                                                          | Return to repair center.                                                                                                                                               |
|                                                                               |                                                                         | The battery voltage is too high.                                                                  | Check if spec and quantity of batteries are meet requirements.                                                                                                         |
|                                                                               | Fault code 01                                                           | Fan fault                                                                                         | Replace the fan.                                                                                                                                                       |
|                                                                               | Fault code 06/58                                                        | Output abnormal (Inverter voltage below than 190Vac or is higher than 260Vac)                     | 1. Reduce the connected load.<br>2. Return to repair center                                                                                                            |
|                                                                               | Fault code 08/09/53/57                                                  | Internal components failed.                                                                       | Return to repair center.                                                                                                                                               |
|                                                                               | Fault code 50                                                           | PFC over current or surge.                                                                        | Restart the unit, if the error happens again, please return to repair center.                                                                                          |
|                                                                               | Fault code 51                                                           | OP over current or surge.                                                                         |                                                                                                                                                                        |
|                                                                               | Fault code 52                                                           | Bus voltage is too low.                                                                           |                                                                                                                                                                        |
|                                                                               | Fault code 55                                                           | Output voltage is unbalanced.                                                                     |                                                                                                                                                                        |
| Fault code 56                                                                 | Battery is not connected well or fuse is burnt.                         | If the battery is connected well, please return to repair center.                                 |                                                                                                                                                                        |



# PARALLEL FUNCTION

## 1. Introduction

This inverter can be used in parallel for two applications.

1. Parallel operation in single phase with up to 9 units. The supported maximum output power is 45KW/45KVA.
2. Maximum 9 units work together to support three-phase equipment. Seven units support one phase maximum. The supported maximum output power is 45KW/45KVA and one phase can be up to 35KW/35KVA

**NOTE:** If this unit is bundled with share current cable and parallel cable, this inverter is default supported parallel operation. You may skip section 3. If not, please purchase parallel kit and install this unit by following instruction from professional technical personnel in local dealer.

## 2. Package Contents

In parallel kit, you will find the following items in the package:

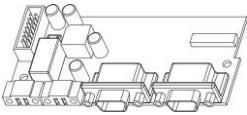

Parallel board

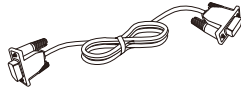

Parallel communication cable



Current sharing cable

## 3. Parallel board installation

**Step 1:** Remove bottom case by unscrewing all screws as shown below.

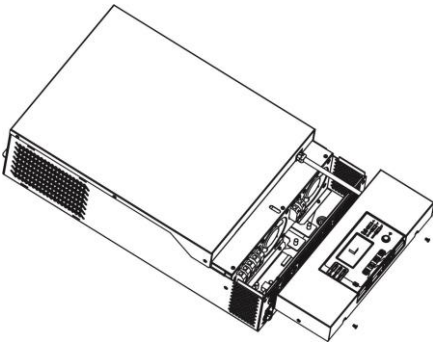

**Step 2:** Remove two screws as below chart and remove 2-pin and 14-pin cables. Take out the board under the communication board.

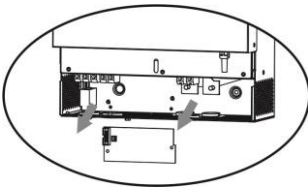

**Step 3:** Remove two screws as below chart to take out cover of parallel communication.

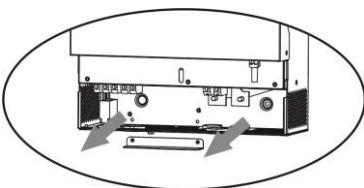

**Step 4:** Install new parallel board with 2 screws tightly.

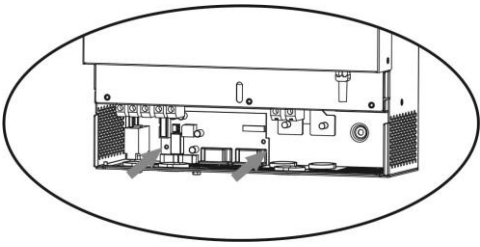

**Step 5:** Re-connect 2-pin and 14-pin to original position on parallel board as shown below chart.

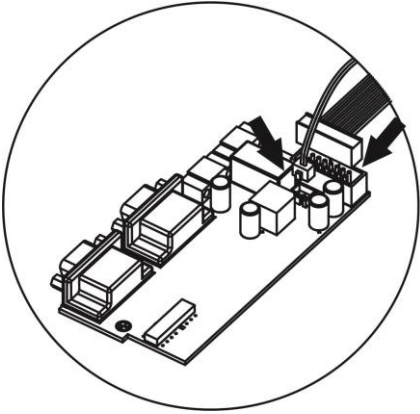

**Step 6:** Put wire cover back to the unit. Now the inverter is providing parallel operation function.

#### 4. Mounting the Unit

When installing multiple units, please follow below chart.

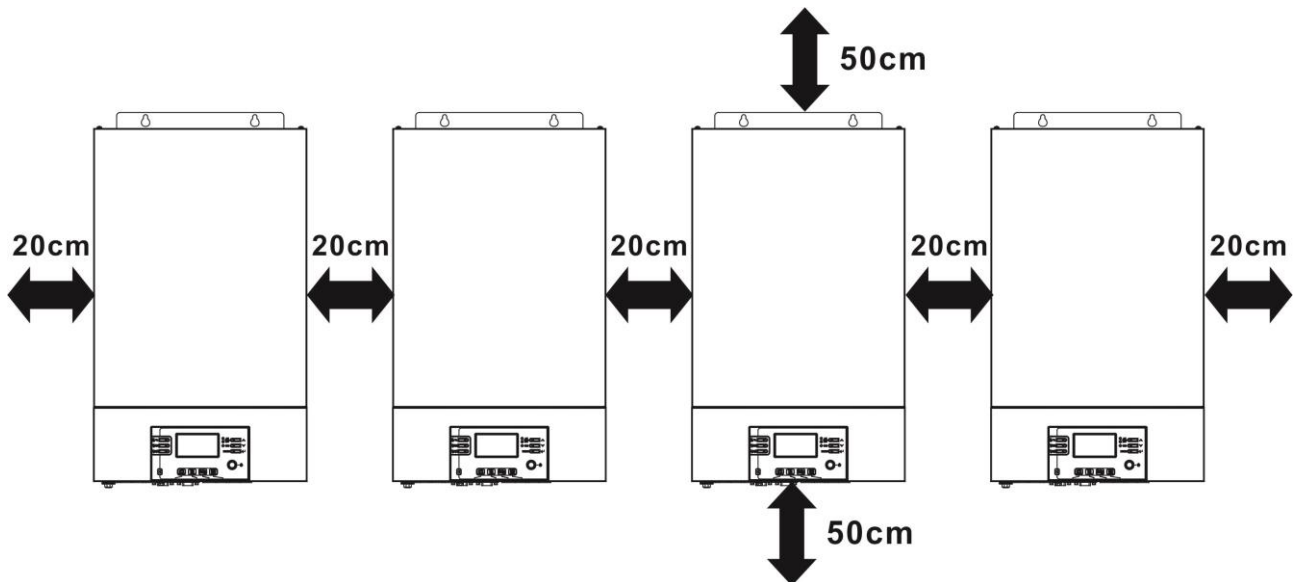

**NOTE:** For proper air circulation to dissipate heat, allow a clearance of approx. 20 cm to the side and approx. 50 cm above and below the unit. Be sure to install each unit in the same level.

## 5. Wiring Connection

The cable size of each inverter is shown as below:

### Recommended battery cable and terminal size for each inverter:

| Model | Wire Size | Ring Terminal         |            |        | Torque value |
|-------|-----------|-----------------------|------------|--------|--------------|
|       |           | Cable mm <sup>2</sup> | Dimensions |        |              |
|       |           |                       | D (mm)     | L (mm) |              |
| 3KW   | 1*1/0AWG  | 60                    | 6.4        | 49.7   | 2~ 3 Nm      |
|       | 2*4AWG    | 44                    | 6.4        | 49.7   |              |
| 5KW   | 1*1/0AWG  | 60                    | 6.4        | 49.7   | 2~ 3 Nm      |
|       | 2 * 4AWG  | 44                    | 6.4        | 49.7   |              |

### Ring terminal:

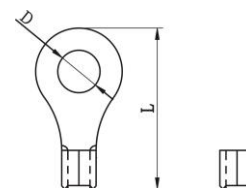

**WARNING:** Be sure the length of all battery cables is the same. Otherwise, there will be voltage difference between inverter and battery to cause parallel inverters not working.

### Recommended AC input and output cable size for each inverter:

| Model | AWG no. | Torque    |
|-------|---------|-----------|
| 3KW   | 10 AWG  | 1.2~1.6Nm |
| 5KW   | 8 AWG   | 1.4~1.6Nm |

You need to connect the cables of each inverter together. Take the battery cables for example: You need to use a connector or bus-bar as a joint to connect the battery cables together, and then connect to the battery terminal. The cable size used from joint to battery should be X times cable size in the tables above. "X" indicates the number of inverters connected in parallel.

Regarding AC input and output, please also follow the same principle.

**CAUTION!!** Please install the breaker at the battery and AC input side. This will ensure the inverter can be securely disconnected during maintenance and fully protected from over current of battery or AC input. The recommended mounted location of the breakers is shown in the figures in 5-1 and 5-2.

### Recommended breaker specification of battery for each inverter:

|       |            |
|-------|------------|
| Model | 1 unit*    |
| 3KW   | 150A/60VDC |
| 5KW   | 125A/80VDC |

\*If you want to use only one breaker at the battery side for the whole system, the rating of the breaker should be X times current of 1 unit. "X" indicates the number of inverters connected in parallel.

### Recommended breaker specification of AC input:

| Model | 2 units | 3 units | 4 units | 5 units | 6 units | 7 units | 8 units | 9 units |
|-------|---------|---------|---------|---------|---------|---------|---------|---------|
| 3KW   | 80A     | 120A    | 160A    | 200A    | 240A    | 280A    | 320A    | 360A    |
| 5KW   | 100A    | 150A    | 200A    | 250A    | 300A    | 350A    | 400A    | 450A    |

**Note1:** Also, you can use 40A breaker for 3KW and 50A for 5KW for only 1 unit and install one breaker at its AC input in each inverter.

**Note2:** Regarding three-phase system, you can use 4-pole breaker directly and the rating of the breaker should be compatible with the phase current limitation from the phase with maximum units

### Recommended battery capacity

| Inverter parallel numbers | 2     | 3      | 4      | 5      | 6      | 7      | 8      | 9      |
|---------------------------|-------|--------|--------|--------|--------|--------|--------|--------|
| Battery Capacity          | 800AH | 1200AH | 1600AH | 2000AH | 2400AH | 2800AH | 3200AH | 3600AH |

**WARNING!** Be sure that all inverters will share the same battery bank. Otherwise, the inverters will transfer to fault mode.

### 5-1. Parallel Operation in Single phase

Two inverters in parallel:

#### Power Connection

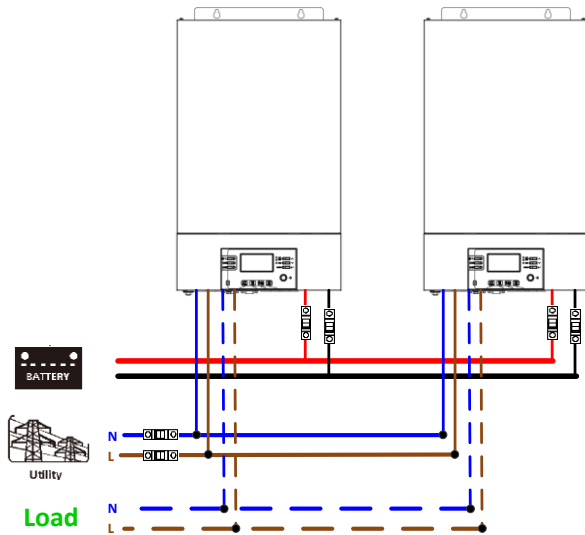

#### Communication Connection

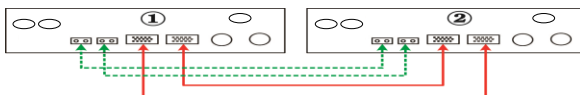

Three inverters in parallel:

#### Power Connection

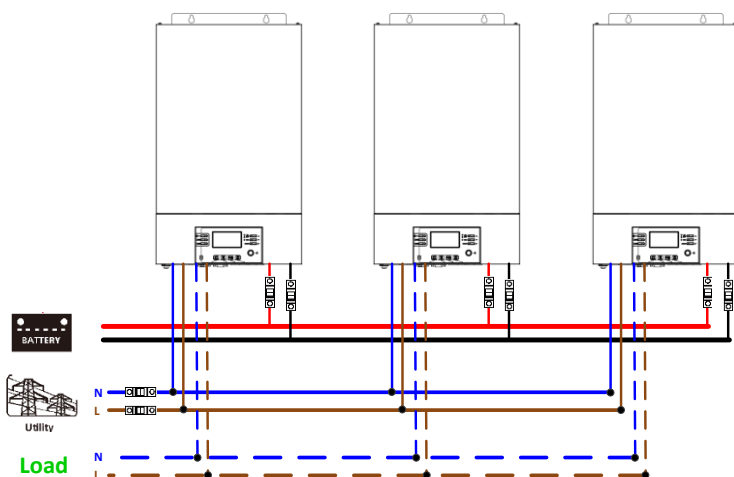

### Communication Connection

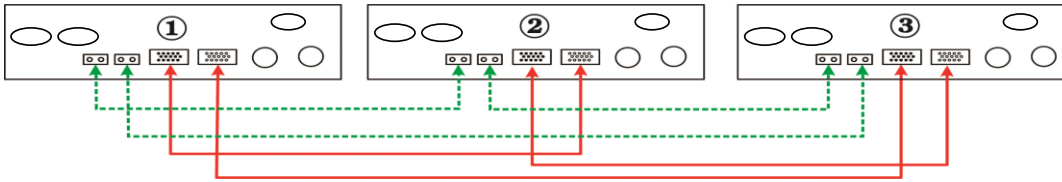

Four inverters in parallel:

### Power Connection

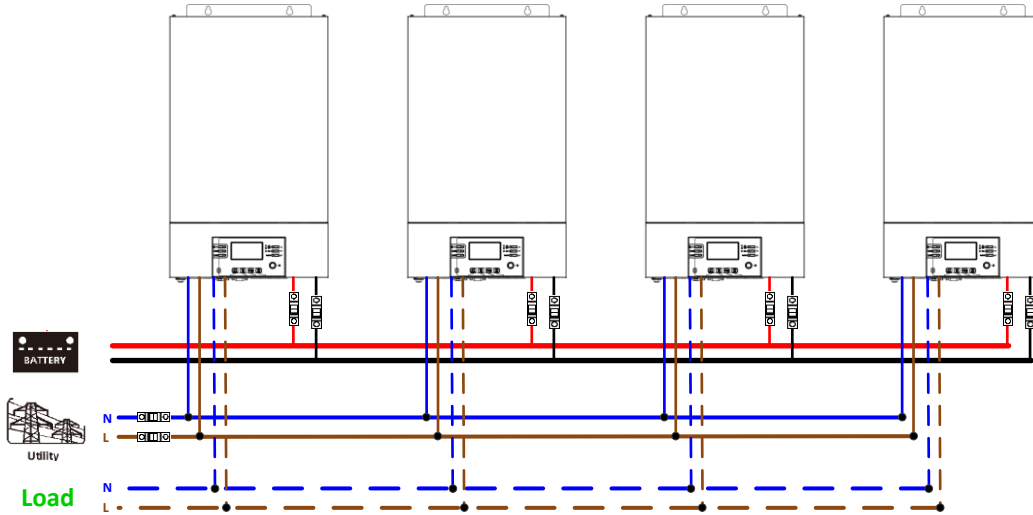

### Communication Connection

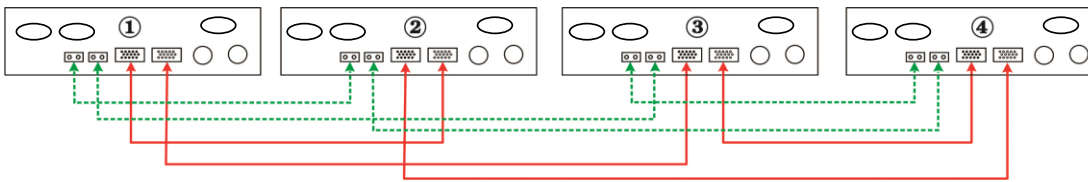

Five inverters in parallel:

### Power Connection

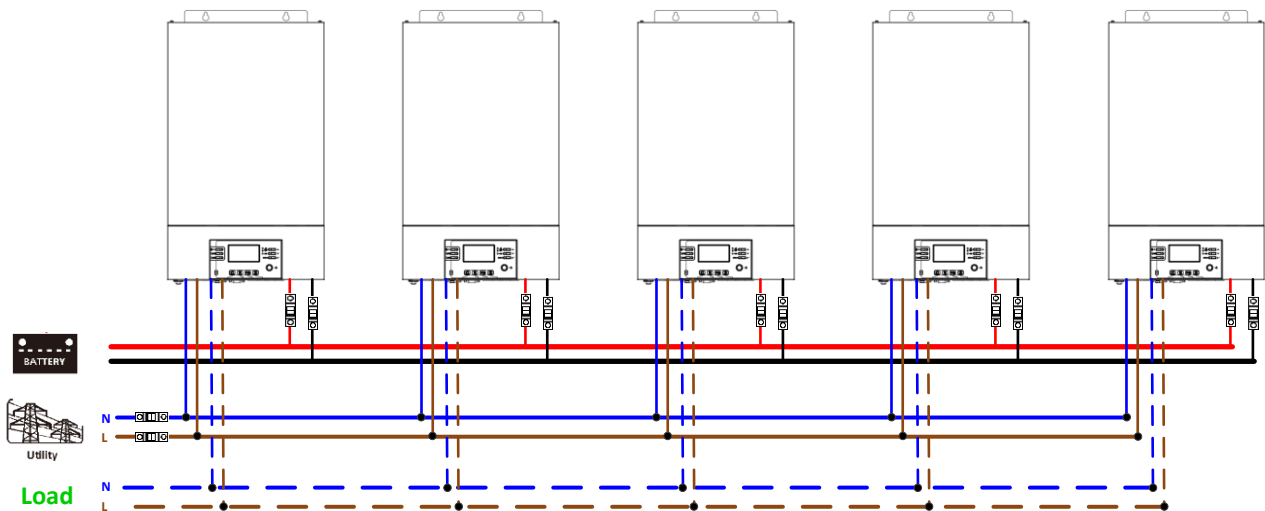

### Communication Connection

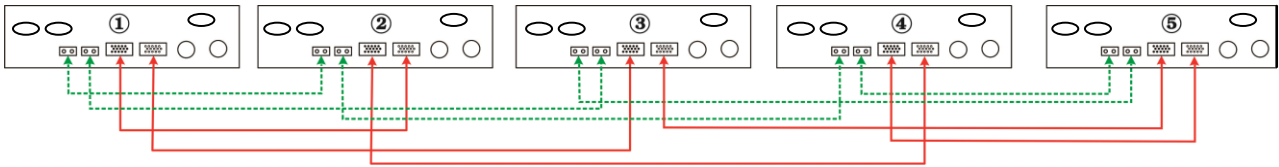

Six inverters in parallel:

### Power Connection

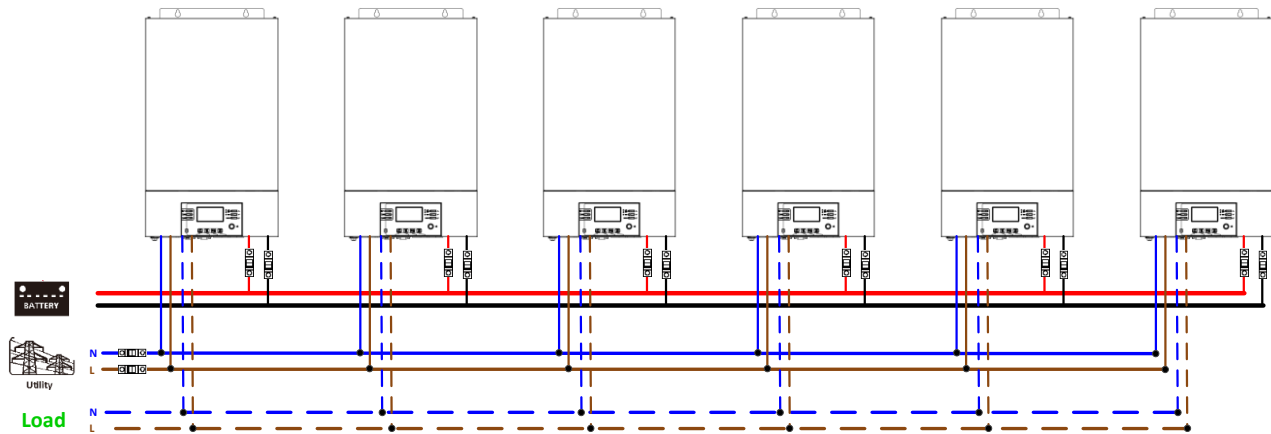

### Communication Connection

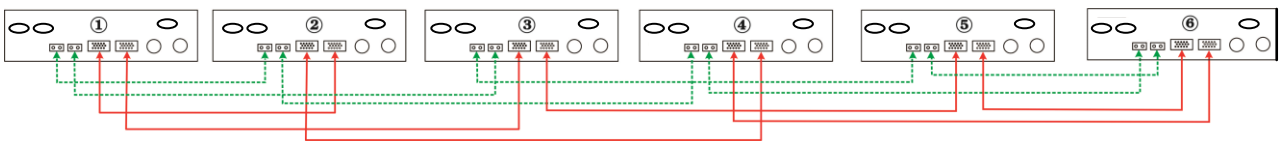

Seven inverters in parallel:

### Power Connection

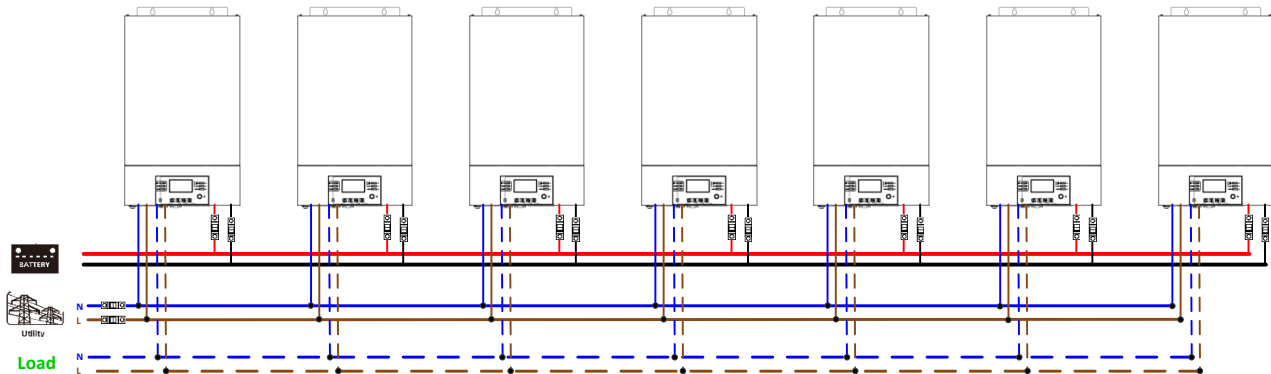

### Communication Connection

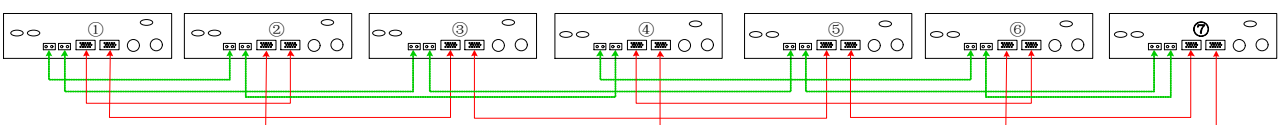

Eight inverters in parallel:

### Power Connection

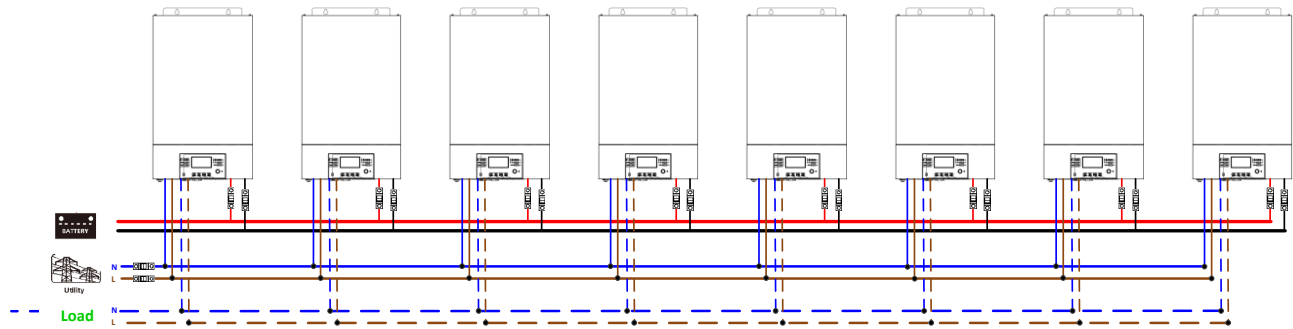

### Communication Connection

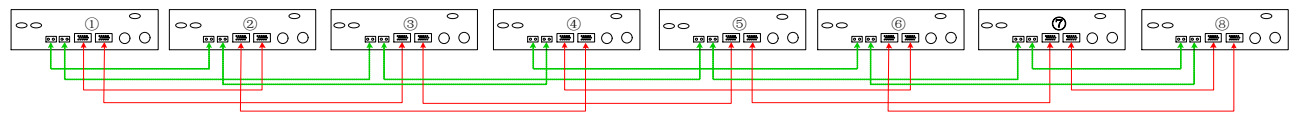

Nine inverters in parallel:

### Power Connection

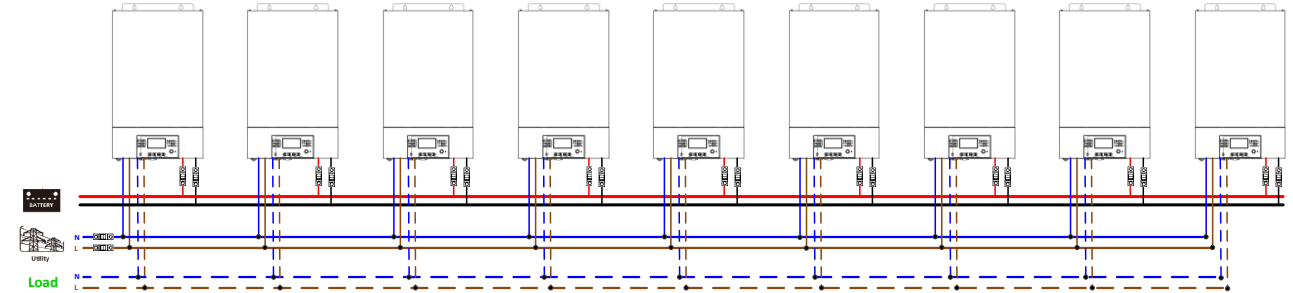

### Communication Connection

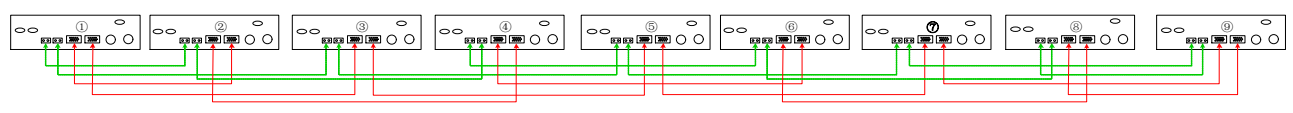

## 5-2. Support 3-phase equipment

Three inverters in each phase:

### Power Connection

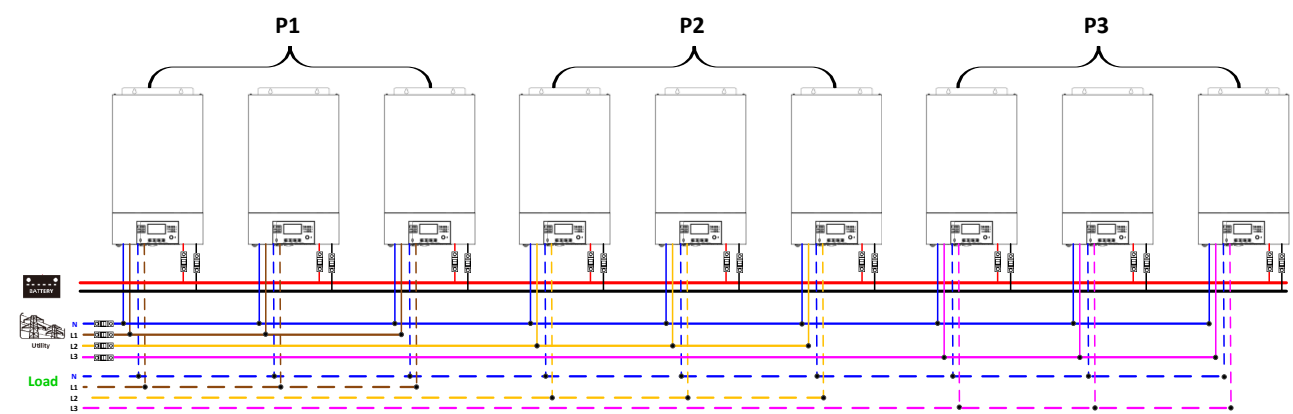

## Communication Connection

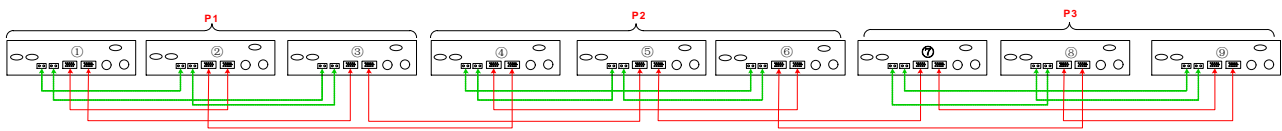

**WARNING:** Do not connect the current sharing cable between the inverters which are in different phases. Otherwise, it may damage the inverters.

Two inverters in each phase:

## Power Connection

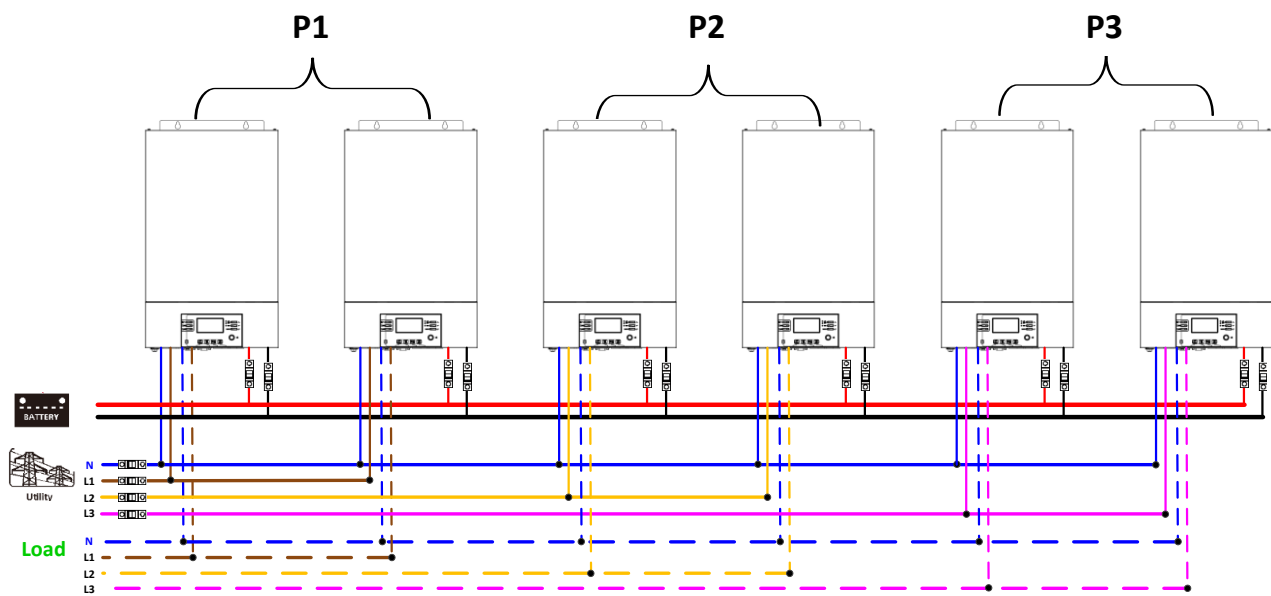

## Communication Connection

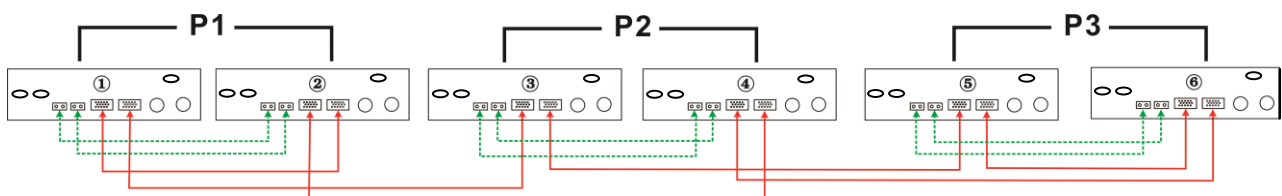



Seven inverters in one phase and one inverter for the other two phases:

**Power Connection**

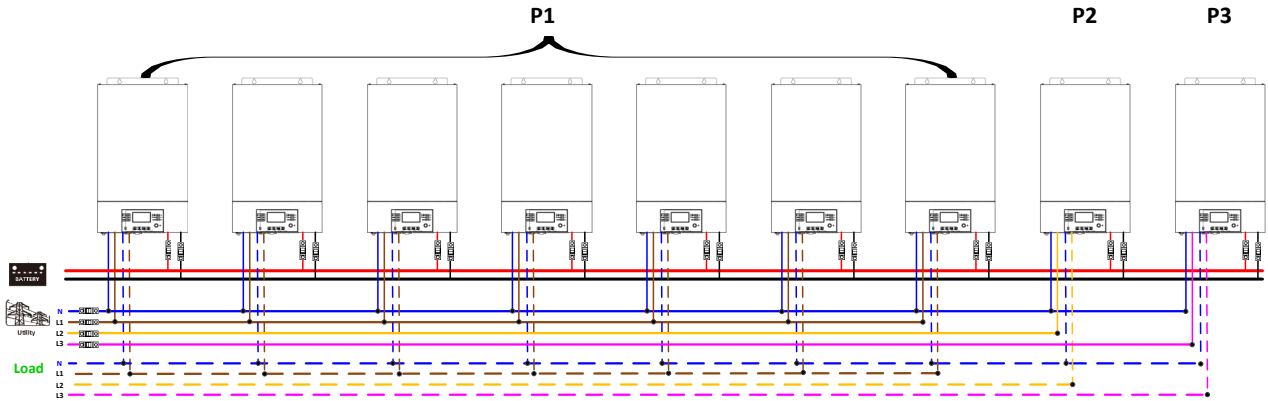

**Note:** It's up to customer's demand to pick 7 inverters on any phase.

P1: L1-phase, P2: L2-phase, P3: L3-phase.

**Communication Connection**

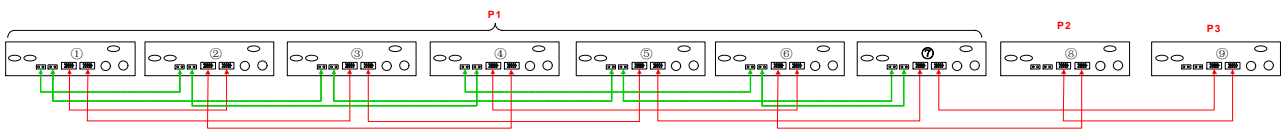

**Note:** If there is only one unit in one phase, this unit doesn't need to connect the current sharing cable.

Or you connect it like as below:

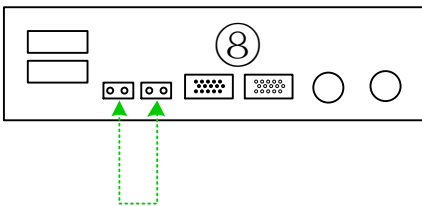

Four inverters in one phase and one inverter for the other two phases:

**Power Connection**

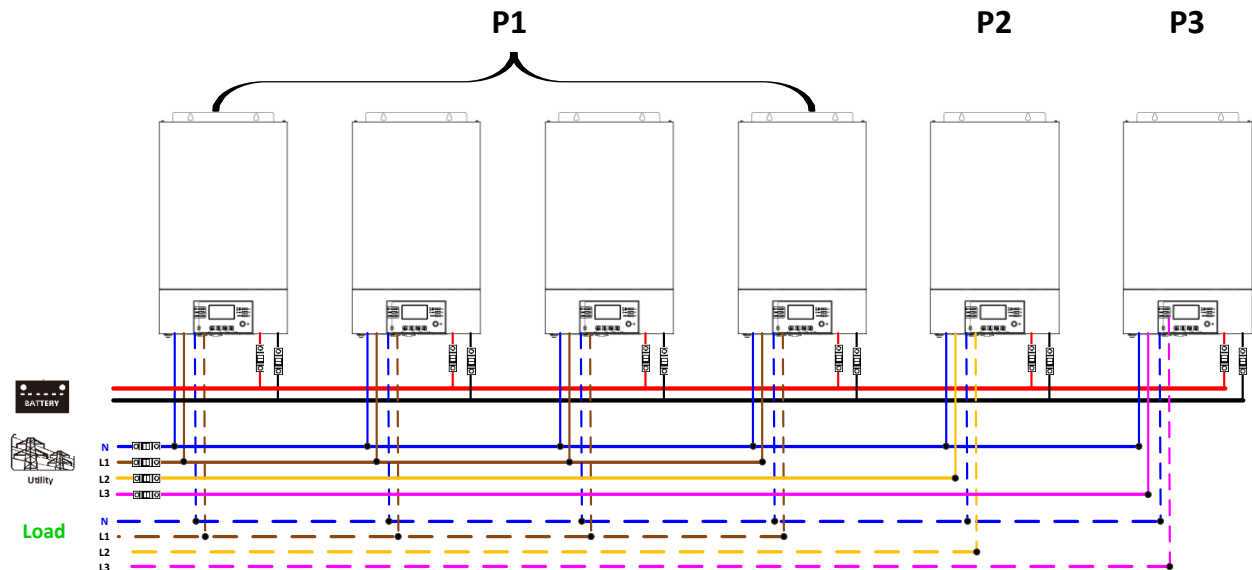

**Note:** It's up to customer's demand to pick 4 inverters on any phase.

P1: L1-phase, P2: L2-phase, P3: L3-phase.

### Communication Connection

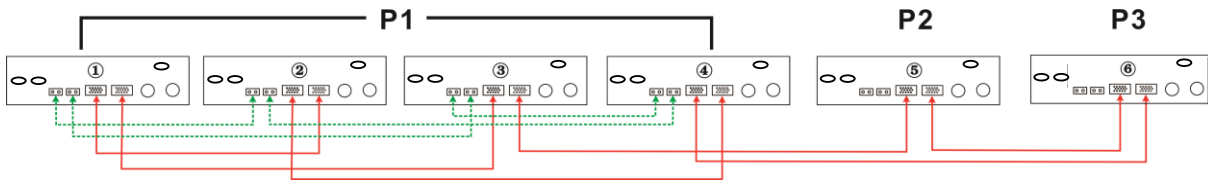

Three inverters in one phase, two inverters in second phase and one inverter for the third phase:

### Power Connection

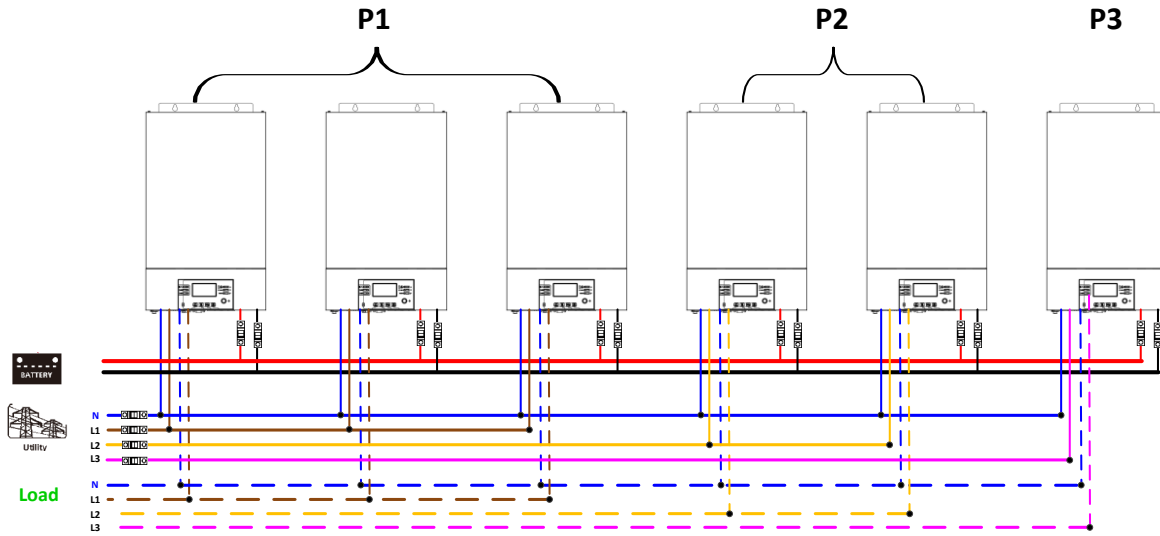

### Communication Connection

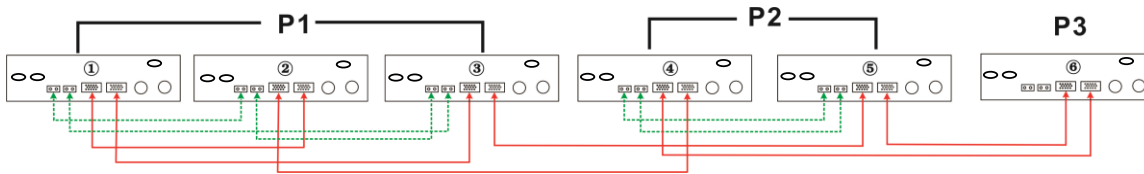

Three inverters in one phase and only one inverter for the remaining two phases:

### Power Connection

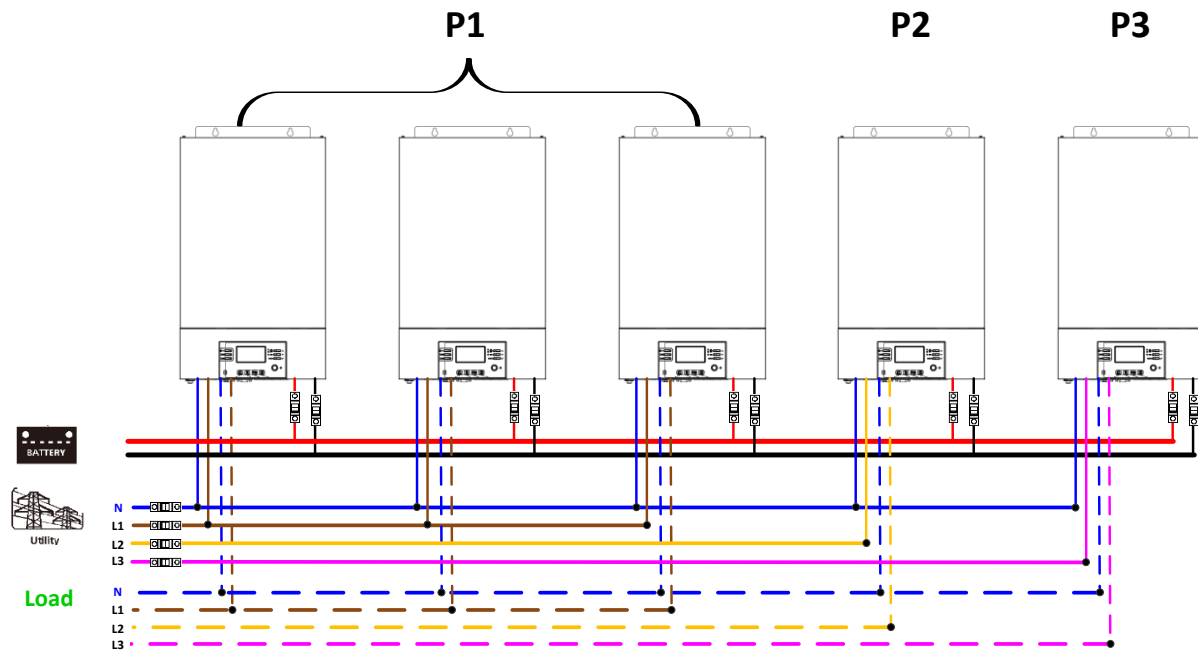

### Communication Connection

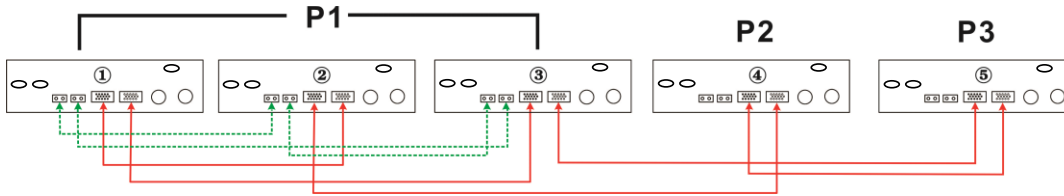

Two inverters in two phases and only one inverter for the remaining phase:

### Power Connection

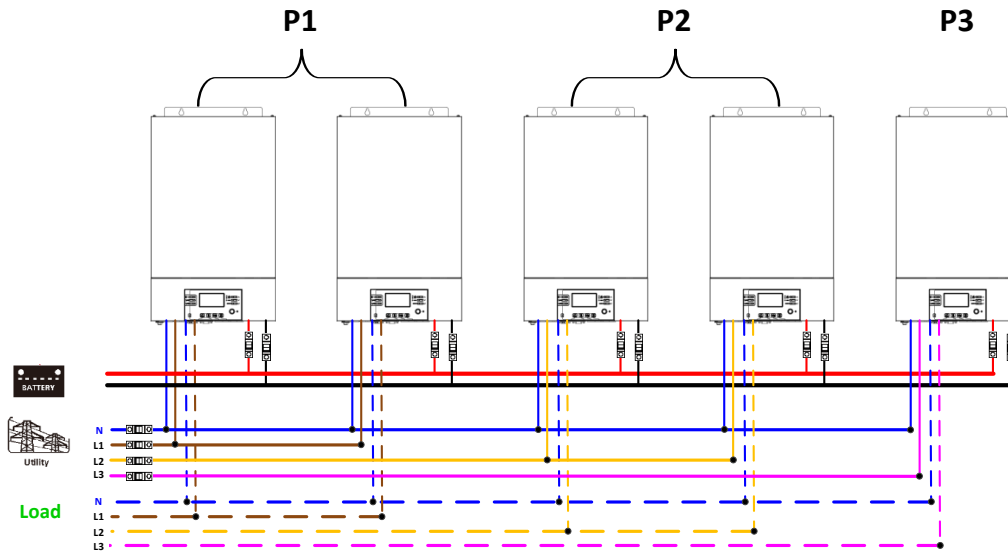

### Communication Connection

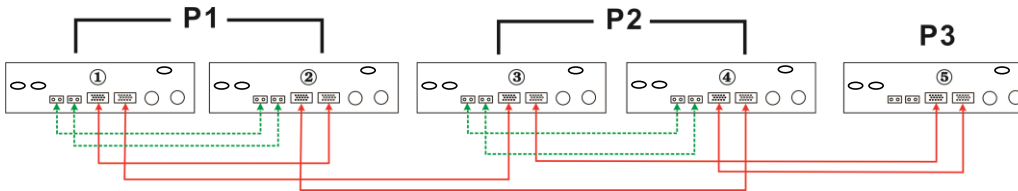

Two inverters in one phase and only one inverter for the remaining phases:

### Power Connection

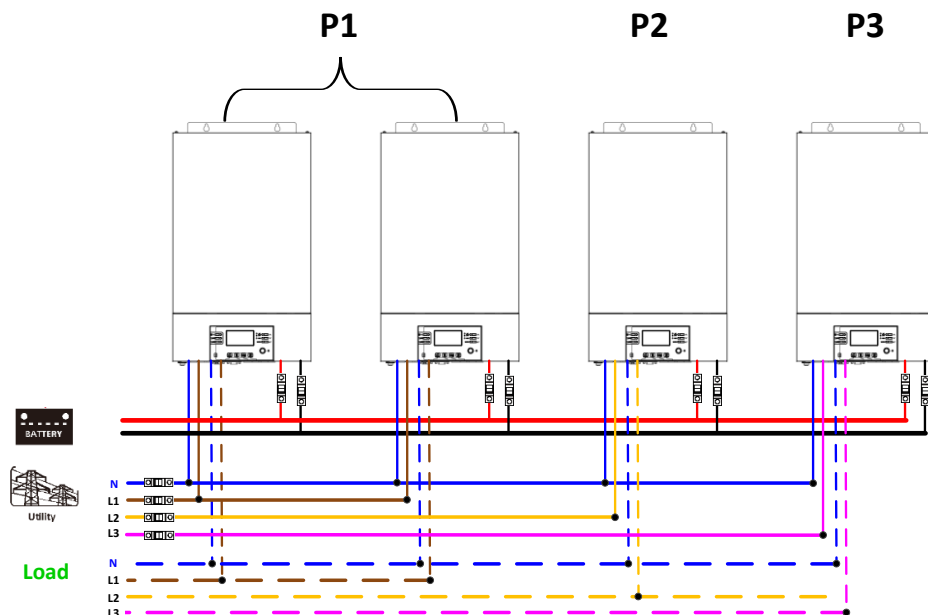

### Communication Connection

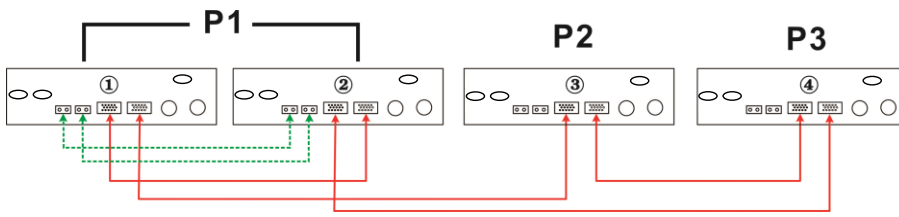

One inverter in each phase:

### Power Connection

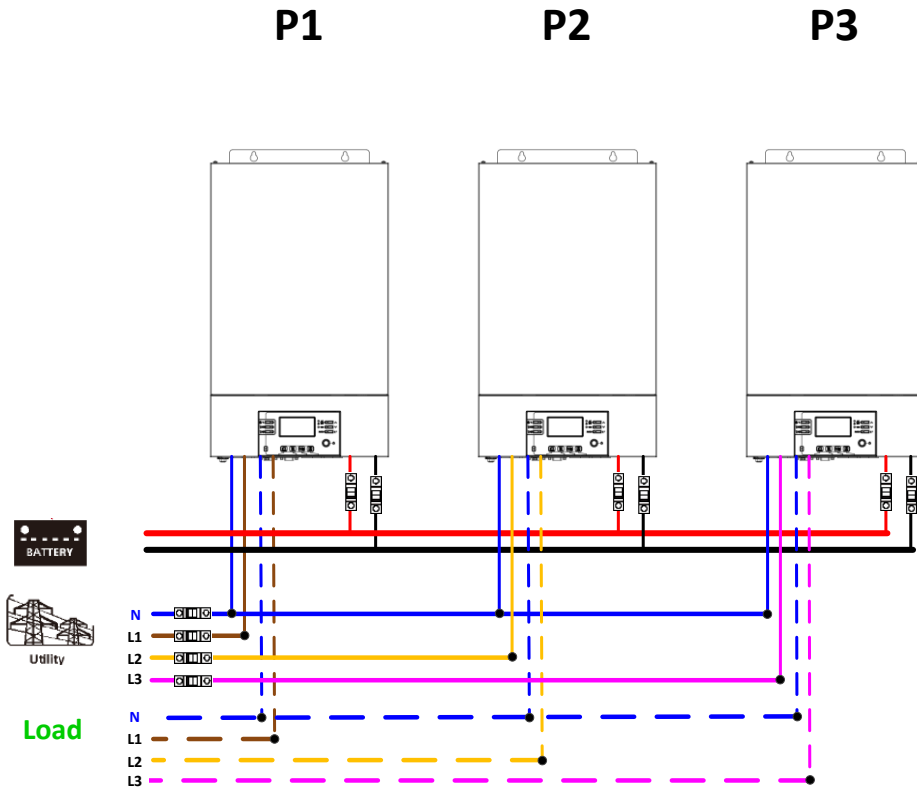

### Communication Connection

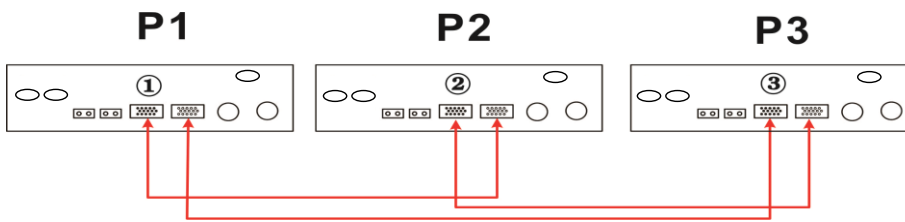

**WARNING:** Do not connect the current sharing cable between the inverters which are in different phases. Otherwise, it may damage the inverters.





### 6. PV Connection

Please refer to user manual of single unit for PV Connection.

**CAUTION:** Each inverter should connect to PV modules separately.

## 7. LCD Setting and Display

### Setting Program:

| Program                                                                                             | Description                                                                                                                                                                                                                                                                                                                                                                                                                                                                                                                                                             | Selectable option                                                                                |                                                                                                                                                       |
|-----------------------------------------------------------------------------------------------------|-------------------------------------------------------------------------------------------------------------------------------------------------------------------------------------------------------------------------------------------------------------------------------------------------------------------------------------------------------------------------------------------------------------------------------------------------------------------------------------------------------------------------------------------------------------------------|--------------------------------------------------------------------------------------------------|-------------------------------------------------------------------------------------------------------------------------------------------------------|
| 28                                                                                                  | AC output mode<br>*This setting is able to set up only when the inverter is in standby mode. Be sure that on/off switch is in "OFF" status.                                                                                                                                                                                                                                                                                                                                                                                                                             | Single<br>28    | When the unit is operated alone, please select "SIG" in program 28.                                                                                   |
|                                                                                                     |                                                                                                                                                                                                                                                                                                                                                                                                                                                                                                                                                                         | SIG                                                                                              |                                                                                                                                                       |
|                                                                                                     |                                                                                                                                                                                                                                                                                                                                                                                                                                                                                                                                                                         | Parallel<br>28  | When the units are used in parallel for single phase application, please select "PAL" in program 28. Please refer to 5-1 for detailed information.    |
|                                                                                                     |                                                                                                                                                                                                                                                                                                                                                                                                                                                                                                                                                                         | PAL                                                                                              |                                                                                                                                                       |
| L1 phase:<br>28    | When the units are operated in 3-phase application, please choose "3PX" to define each inverter.<br>It is required to have at least 3 inverters or maximum 9 inverters to support three-phase equipment. It's required to have at least one inverter in each phase or it's up to four inverters in one phase. Please refers to 5-2 for detailed information.<br>Please select "3P1" in program 28 for the inverters connected to L1 phase, "3P2" in program 28 for the inverters connected to L2 phase and "3P3" in program 28 for the inverters connected to L3 phase. |                                                                                                  |                                                                                                                                                       |
| L2 phase:<br>28    |                                                                                                                                                                                                                                                                                                                                                                                                                                                                                                                                                                         |                                                                                                  |                                                                                                                                                       |
| L3 phase:<br>28  |                                                                                                                                                                                                                                                                                                                                                                                                                                                                                                                                                                         |                                                                                                  |                                                                                                                                                       |
|                                                                                                     |                                                                                                                                                                                                                                                                                                                                                                                                                                                                                                                                                                         | 3P1                                                                                              | Be sure to connect share current cable to units which are on the same phase.<br>Do NOT connect share current cable between units on different phases. |
|                                                                                                     |                                                                                                                                                                                                                                                                                                                                                                                                                                                                                                                                                                         | 3P2                                                                                              |                                                                                                                                                       |
|                                                                                                     |                                                                                                                                                                                                                                                                                                                                                                                                                                                                                                                                                                         | 3P3                                                                                              |                                                                                                                                                       |

### Fault code display:

| Fault Code | Fault Event                                       | Icon on |
|------------|---------------------------------------------------|---------|
| 60         | Power feedback protection                         | F60     |
| 71         | Firmware version inconsistent                     | F71     |
| 72         | Current sharing fault                             | F72     |
| 80         | CAN fault                                         | F80     |
| 81         | Host loss                                         | F81     |
| 82         | Synchronization loss                              | F82     |
| 83         | Battery voltage detected different                | F83     |
| 84         | AC input voltage and frequency detected different | F84     |
| 85         | AC output current unbalance                       | F85     |
| 86         | AC output mode setting is different               | F86     |

## 8. Commissioning

### Parallel in single phase

Step 1: Check the following requirements before commissioning:

- Correct wire connection
- Ensure all breakers in Line wires of load side are open and each Neutral wires of each unit are connected together.

Step 2: Turn on each unit and set "PAL" in LCD setting program 28 of each unit. And then shut down all units.

**NOET:** It's necessary to turn off switch when setting LCD program. Otherwise, the setting can not be programmed.

Step 3: Turn on each unit.

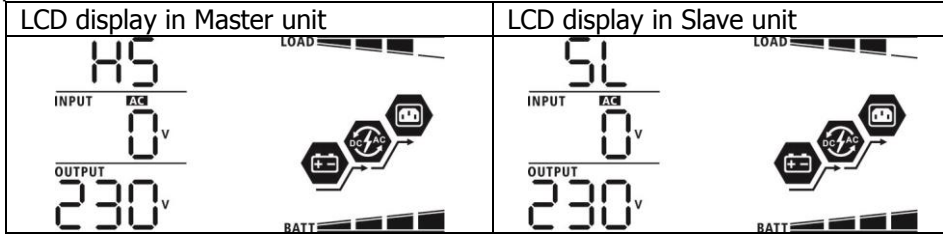

**NOTE:** Master and slave units are randomly defined.

Step 4: Switch on all AC breakers of Line wires in AC input. It's better to have all inverters connect to utility at the same time. If detecting AC connection, they will work normally.

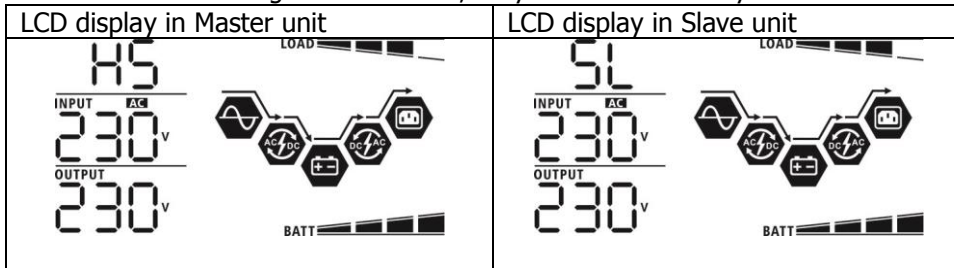

Step 5: If there is no more fault alarm, the parallel system is completely installed.

Step 6: Please switch on all breakers of Line wires in load side. This system will start to provide power to the load.

### Support three-phase equipment

Step 1: Check the following requirements before commissioning:

- Correct wire connection
- Ensure all breakers in Line wires of load side are open and each Neutral wires of each unit are connected together.

Step 2: Turn on all units and configure LCD program 28 as P1, P2 and P3 sequentially. And then shut down all units.

**NOET:** It's necessary to turn off switch when setting LCD program. Otherwise, the setting can not be programmed.

Step 3: Turn on all units sequentially.

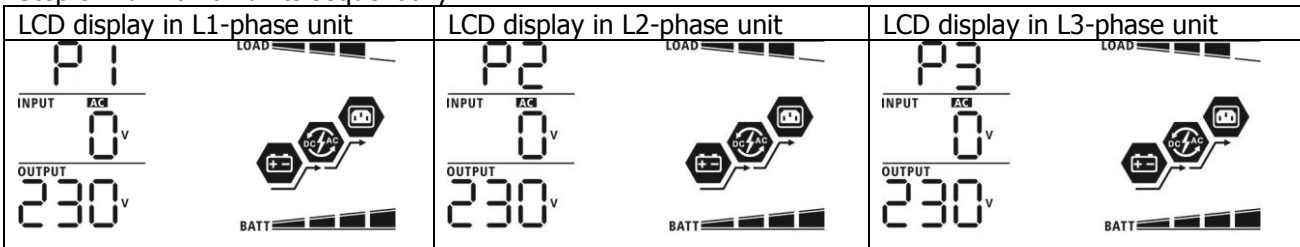

Step 4: Switch on all AC breakers of Line wires in AC input. If AC connection is detected and three phases are matched with unit setting, they will work normally. Otherwise, the AC icon will flash and they will not work in line mode.

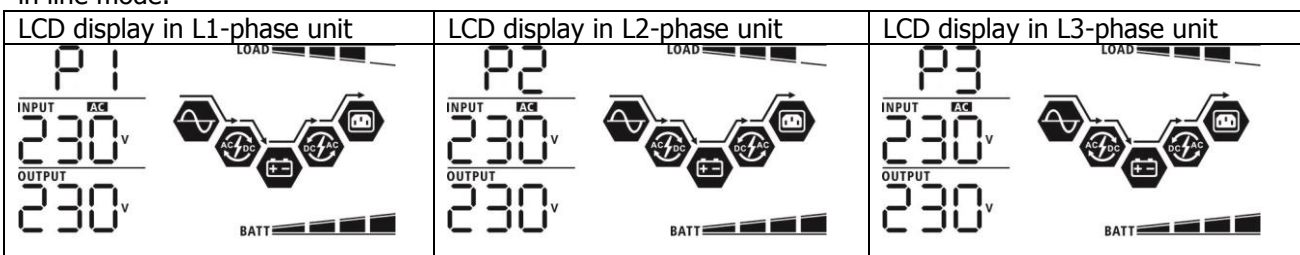

Step 5: If there is no more fault alarm, the system to support 3-phase equipment is completely installed.

Step 6: Please switch on all breakers of Line wires in load side. This system will start to provide power to the load.

Note 1: To avoid overload occurring, before turning on breakers in load side, it's better to have whole system in operation first.

Note 2: Transfer time for this operation exists. Power interruption may happen to critical devices, which cannot bear transfer time.

## 9. Trouble shooting

| Situation  |                                                        | Solution                                                                                                                                                                                                                                                                                                                                                                                                                                                                                                                                 |
|------------|--------------------------------------------------------|------------------------------------------------------------------------------------------------------------------------------------------------------------------------------------------------------------------------------------------------------------------------------------------------------------------------------------------------------------------------------------------------------------------------------------------------------------------------------------------------------------------------------------------|
| Fault Code | Fault Event Description                                |                                                                                                                                                                                                                                                                                                                                                                                                                                                                                                                                          |
| 60         | Current feedback into the inverter is detected.        | <ol style="list-style-type: none"> <li>Restart the inverter.</li> <li>Check if L/N cables are not connected reversely in all inverters.</li> <li>For parallel system in single phase, make sure the sharing are connected in all inverters.<br/>For supporting three-phase system, make sure the sharing cables are connected in the inverters in the same phase, and disconnected in the inverters in different phases.</li> <li>If the problem remains, please contact your installer.</li> </ol>                                      |
| 71         | The firmware version of each inverter is not the same. | <ol style="list-style-type: none"> <li>Update all inverter firmware to the same version.</li> <li>Check the version of each inverter via LCD setting and make sure the CPU versions are same. If not, please contact your instraller to provide the firmware to update.</li> <li>After updating, if the problem still remains, please contact your installer.</li> </ol>                                                                                                                                                                 |
| 72         | The output current of each inverter is different.      | <ol style="list-style-type: none"> <li>Check if sharing cables are connected well and restart the inverter.</li> <li>If the problem remains, please contact your installer.</li> </ol>                                                                                                                                                                                                                                                                                                                                                   |
| 80         | CAN data loss                                          | <ol style="list-style-type: none"> <li>Check if communication cables are connected well and restart the inverter.</li> <li>If the problem remains, please contact your installer.</li> </ol>                                                                                                                                                                                                                                                                                                                                             |
| 81         | Host data loss                                         |                                                                                                                                                                                                                                                                                                                                                                                                                                                                                                                                          |
| 82         | Synchronization data loss                              |                                                                                                                                                                                                                                                                                                                                                                                                                                                                                                                                          |
| 83         | The battery voltage of each inverter is not the same.  | <ol style="list-style-type: none"> <li>Make sure all inverters share same groups of batteries together.</li> <li>Remove all loads and disconnect AC input and PV input. Then, check battery voltage of all inverters. If the values from all inverters are close, please check if all battery cables are the same length and same material type. Otherwise, please contact your installer to provide SOP to calibrate battery voltage of each inverter.</li> <li>If the problem still remains, please contact your installer.</li> </ol> |
| 84         | AC input voltage and frequency are detected different. | <ol style="list-style-type: none"> <li>Check the utility wiring connction and restart the inverter.</li> <li>Make sure utility starts up at same time. If there are breakers installed between utility and inverters, please be sure all breakers can be turned on AC input at same time.</li> <li>If the problem remains, please contact your installer.</li> </ol>                                                                                                                                                                     |
| 85         | AC output current unbalance                            | <ol style="list-style-type: none"> <li>Restart the inverter.</li> <li>Remove some excessive loads and re-check load information from LCD of inverters. If the values are different, please check if AC input and output cables are in the same length and material type.</li> <li>If the problem remains, please contact your installer.</li> </ol>                                                                                                                                                                                      |
| 86         | AC output mode setting is different.                   | <ol style="list-style-type: none"> <li>Switch off the inverter and check LCD setting #28.</li> <li>For parallel system in single phase, make sure no 3P1, 3P2 or 3P3 is set on #28.<br/>For upporting three-phase system, make sure no "PAL" is set on #28.</li> <li>If the problem remains, please contact your installer.</li> </ol>                                                                                                                                                                                                   |

## Appendix I: Approximate Back-up Time Table

| Model | Load (VA) | Backup Time @24Vdc 200Ah (min) | Backup Time @24Vdc 400Ah (min) |
|-------|-----------|--------------------------------|--------------------------------|
| 3KW   | 300       | 898                            | 2200                           |
|       | 600       | 444                            | 1050                           |
|       | 900       | 249                            | 606                            |
|       | 1200      | 190                            | 454                            |
|       | 1500      | 136                            | 328                            |
|       | 1800      | 112                            | 252                            |
|       | 2100      | 96                             | 216                            |
|       | 2400      | 70                             | 188                            |
|       | 2700      | 62                             | 148                            |
|       | 3000      | 56                             | 134                            |

| Model | Load (VA) | Backup Time @ 48Vdc 200Ah (min) | Backup Time @ 48Vdc 400Ah (min) |
|-------|-----------|---------------------------------|---------------------------------|
| 5KW   | 500       | 1226                            | 2576                            |
|       | 1000      | 536                             | 1226                            |
|       | 1500      | 316                             | 804                             |
|       | 2000      | 222                             | 542                             |
|       | 2500      | 180                             | 430                             |
|       | 3000      | 152                             | 364                             |
|       | 3500      | 130                             | 282                             |
|       | 4000      | 100                             | 224                             |
|       | 4500      | 88                              | 200                             |
|       | 5000      | 80                              | 180                             |

**Note:** Backup time depends on the quality of the battery, age of battery and type of battery.  
Specifications of batteries may vary depending on different manufacturers.